



WATER·ON·WATER™
REVERSE OSMOSIS

INSTALLATION & USER MANUAL

for

WOW WATER RO Systems

MODEL#: WOW50-20-209-001



Scan with QR Reader App
Visit our website: www.wowwater.com

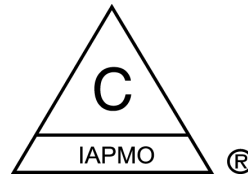

This WOW-50 RO System is Certified by IAPMO R&T against NSF/ANSI 58 for the reduction of Claims specified in the Performance Data Sheet

Powered by  **TOPPER**
MANUFACTURING CORP

Introduction to The WOW RO System

The **WOW RO System** operates by removing contaminants from water at the molecular level. By using your household water pressure to squeeze your water against a special membrane, water molecules are separated from impurities. Rejected dissolved solids are automatically rinsed down the drain leaving only high-quality, delicious water for you to use.

General Information

1. The **WOW RO System** will replenish approximately 1.5 gallons (5.7 L) in 35–90 minutes, depending on your incoming water pressure, quality, and temperature. This appliance is designed with a self-regulating, atmospheric production, and a flush feature that limits the reject water to approximately 2 gallons (7.6 L) for every gallon (liter) of treated water. Your appliance will perform better and last longer with heavy use. We encourage you to water house plants, provide water for pets, cook, mix drinks, fill batteries, etc., with treated water. **Caution: The working capacity of this appliance depends on the pressure, temperature and TDS load of the water supply.** This appliance is not guaranteed to work properly with water pressure less than 20 psi (1.4 bar) and water temperature below 40°F (4°C), or above 100° (37.8C), and TDS over 1,400 ppm.

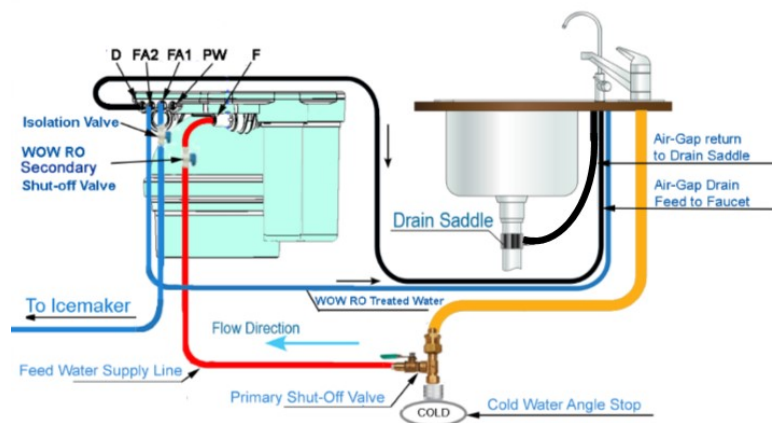

Figure 1: Installation Diagram

2. The storage tank will store 1.5 gallons (5.7 L) of water.
3. The **WOW RO System** can be connected to a variety of appliances, including your automatic ice maker, cold water dispenser in the refrigerator door, coffee maker, water cooler, and other commercial applications.
4. The **WOW RO System** is designed to be connected to cold water only.

Caution: Never run hot water through your appliance.

5. The flow of water through your treated water faucet will not be as strong as your sink faucet.
6. The **WOW RO System** is made of safe, non-toxic, health and environment-friendly materials. BPA Free.

Warning: Do not allow your appliance to freeze.

Figure 1: Installation Diagram

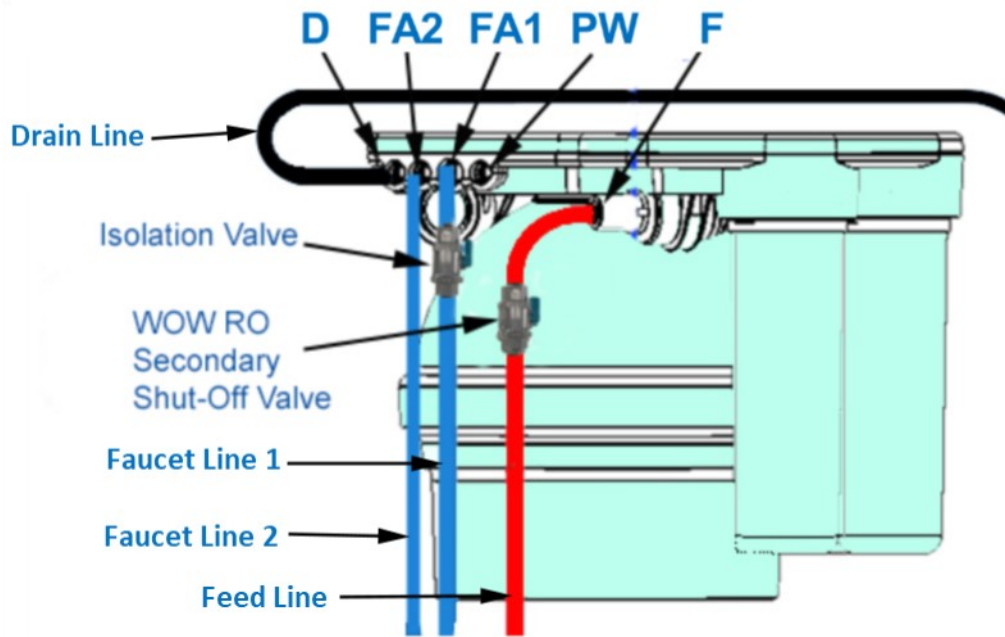
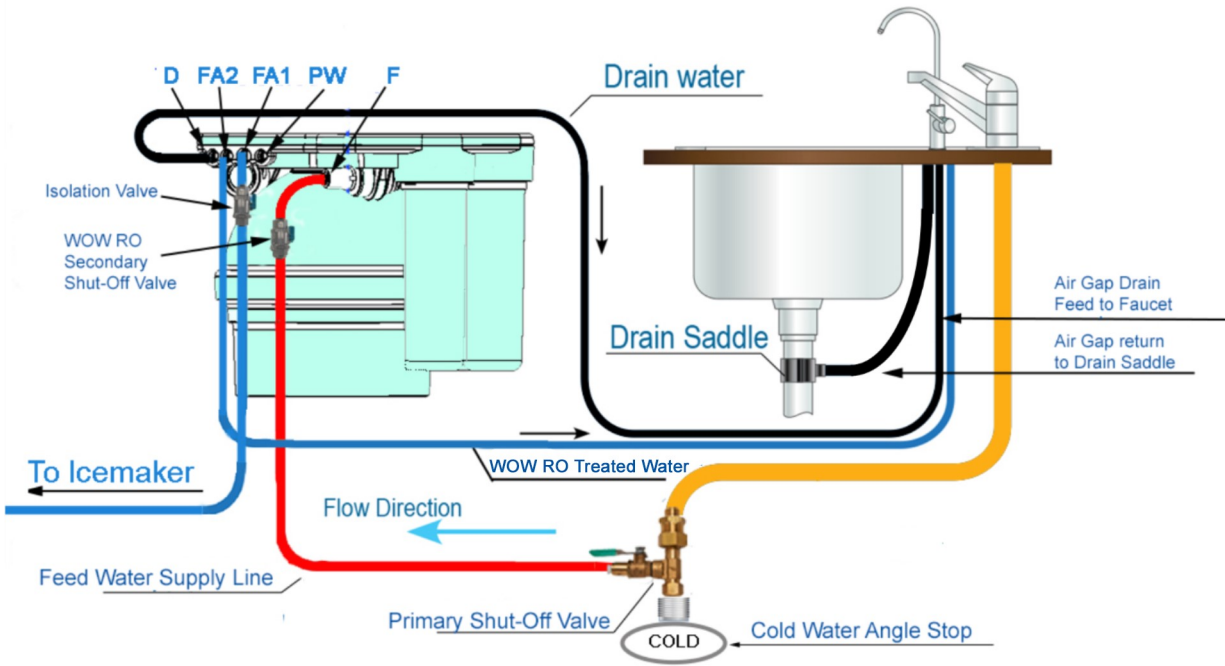

Contents

Introduction to The WOW RO System	2
General Information	2
The Many Uses of RO Water	5,6
Section 1-Installation & Start-up Procedures	7
Avoid Common Mistakes.....	8
Pre-installation Checklist.....	9
Installation Tool List	9
Installation Kit Contents	10,11
Part Inspection	12
Proper Placement of Filters.....	12
Installing the Filter Cartridges	13
Connecting the System.....	14
Start-up Procedure	15
Section 2-Connecting Additional Appliances to WOW RO System	16
Connecting to Multiple Appliances	17
Refrigerator/Ice-maker/Coffee-maker/Cooler setup	18-23
Section 3– When More Water is Needed	24
Adding Extra Storage Tanks.....	25
Modular Expandability	26
Section 4-Plumbing the Sink	27
Install the Drain Saddle Assembly	28
Prepare the Sink for RO Faucet Installation	29
Install the Primary Shut-Off Valve	30
Section 5-Maintenance	31
Changing Filters	32
Recommended Filter Replacement.....	33
WOW RO System Appliance	34
Sanitizing Water-on-Water	35
Recommended Literature & Videos.....	36
Section 6-Troubleshooting	37
Troubleshooting Tables	38,39
Owner Information.....	40
2 Year Limited Warranty	41
Customer Service Notes	42,43
NSF/ANSI 58 Certification—Performance Data Sheet	44

The Many Uses of RO Water

INTERNAL BODY CLEANSING: Water is vital to every process in the body. It also cleanses the body of toxins that affect our well being, provided it is sufficiently pure. Beverages like juice, soda, etc., cannot perform this function. Try 6 - 8 glasses of WOW WATER each day for a month and see if you don't experience a noticeable change in some aspect of your health and wellbeing. WOW WATER is the foundation of every excellent cleansing program recommended by your health advisor.

COOKING: Ordinary tap water contains chemical additives, mineral salts, and organic impurities, that interfere with the natural flavor of vegetables, soups, and nearly anything cooked in or with water. We even recommend cooking food like spaghetti or steaming vegetables in WOW WATER – something bottled water users find much too costly. One of the unexpected benefits you'll discover is that your WOW WATER puts an end to the annoying scale build-up on your pots and pans.

JUICES AND MIXES: "Just add water," the label says. Your WOW WATER system allows you to add water without the impurities and bad taste. Juice concentrates, particularly, will taste better than ever. Why? Because you'll be replacing the same pure water removed from the fresh juice during processing which allows the full flavor to develop.

COFFEE, TEA, AND OTHER BEVERAGES: Most beverages are over 95 percent water and turn out to be no better than the water from which they are made. Mineral salts and organic tastes and odors interfere with the chemistry of coffee and especially tea making. Your WOW WATER allows the full essence of your brews to come through.

ICE CUBES: If your ice is cloudy or melts too quickly, you won't believe the difference your WOW WATER makes! It's the mineral salts in water that make ice cloudy and soft. With WOW WATER, you can expect clearer, harder ice that melts slowly, won't spoil the flavor of beverages, and leaves no annoying residue in your mixed drinks.

LOW SODIUM DIETS: Your WOW WATER system produces water that is perfect for most low sodium (salt restricted) diets. Excess processed table salt (sodium chloride) intake has been linked to hyper-tension and weight gain for some individuals. For those who have a water softener, this too, adds sodium to the water but with a WOW WATER system, drinking water sodium levels will be practically eliminated.

WEIGHT LOSS DIETS: Excess mineral salts in tap water and softened water can result in an increase in body fluids and therefore weight. Your WOW WATER compliments any weight loss program by minimizing this factor. If you've been consuming tap water, try this: Drink at least six glasses of your WOW WATER throughout the day for one month – without changing anything else in your diet. See if you aren't delighted by the number of pounds you'll shed!

RINSING HAIR: For the absolute softest, shiniest hair, there is nothing like a final rinse with your WOW WATER. It has none of the dulling chemicals or mineral salts that are left behind by city water when your hair dries. Furthermore, the pH of WOW WATER is ideal for maintaining optimum hair and skin. Just wash and rinse your hair as usual. Then, pour a container (one quart or liter will do) of your WOW WATER over the hair (you might want to warm it a bit on the stove or microwave). Gently towel dry and appreciate the wonderful results.

PLANTS: There's a lot of misunderstanding about the best water to give your house plants. Many people think that the mineral salts in water are important for the growth of their plants. This is generally untrue. Nature intended plant life to have rain water which is void of mineral salts. Plant nutrients are supplied by elements and bacteria in the soil. All of your greenery, including cut flowers, will thrive better and longer on your WOW WATER. Potted plants won't have to be flushed out regularly to get rid of mineral salt build-up when your WOW WATER is used. Try it; the difference can be dramatic.

The Many Uses of RO Water—Cont.

STEAM IRONS: Your WOW WATER is far superior to tap water for use in steam irons. Mineral salts from tap water build up around the heating elements and waste expensive electricity as well as clog steam vents. Your WOW WATER reduces mineral salt build-up and will substantially extend the life of your steam iron.

HUMIDIFIERS: Humidifiers evaporate water into the air leaving whatever was in the water behind. The dirt, rust, and mineral salts deposited in the humidifier mechanism can cause it to become inefficient, energy wasting, and finally self-destruct. You will soon observe what a great asset WOW WATER can be to your humidifier maintenance.

PREPARING CLEANING PRODUCTS: Many house-holds economize and “Go Green” by mixing their own cleaning solutions from concentrates -whether for cleaning counters, floors, or windows. Dirt and mineral salts in tap water actually interfere with the effectiveness of cleaners, in addition to leaving a dulling residue of spots and streaks behind. If you really want to make your products “new and improved” try mixing them with your WOW WATER . The results are very noticeable.

AQUARIUMS: Fish love pure water too! Whether you have fresh water fish or use fresh water to prepare saltwater aquariums, it’s best to start with water having as few impurities as possible. The WOW WATER system not only effectively removes excess mineral salts, but eliminates both free and combined chlorine (chloramines) which are highly toxic to most fish. For fresh water aquariums, the WOW WATER should be added as make-up water at first so fish become gradually acclimated to the change of chemistry. Always consult with your aquarium specialist for his recommendation when using WOW WATER to replace large volumes of aquarium water.

AUTOMOBILE BATTERIES: Even though some battery manufacturers claim that it’s okay to use tap water, all car batteries will last far longer on your WOW WATER . With the mineral salts virtually eliminated, your WOW WATER will not interfere with the chemistry of your car battery and its lifetime will be maximized.

AUTOMOBILE WINDSHIELD WASHER: How many people do you know who would put bottled water in their car’s windshield washer? You should put your WOW WATER in your washer and see what a difference it makes! The overspray from your washers won’t leave such a mess of spots and streaks. This really becomes a favorite to those who try it.

SPOTLESS WINDOW WASHING: You can expect some impressive results using WOW WATER for window washing. Clean the window with a cleaning solution as usual. A large soft brush is effective and fast. Hose the windows down with tap water. Then as a final rinse, spray your WOW WATER over the windows with a plastic garden sprayer and allow them to dry. There will be no spots and no streaks left behind by dirt or mineral salts. Better yet, a lot of labor is saved from not having to squeegee or towel dry the windows. This is how the real pros do it.

SPOT-FREE RINSING OF GLASSES AND CRYSTAL: If you’ve ever broken your favorite crystal wine glass drying it with a towel, then you’ll really appreciate this. After washing as usual, rinse the glassware by dipping it in a large open container of WOW WATER and allow to air dry. The results will dazzle you.

SPOT-FREE CAR RINSE: Okay, this you may say is pushing it! But those who take the time to try this will be thoroughly amazed and never go back to their old way of washing a car at home. First, save up at least five gallons of your WOW WATER in several plastic containers. Then, after you have thoroughly washed and rinsed your car with tap water as usual, do not wipe down or dry off the car. Instead, immediately pour the WOW WATER (or spray with a plastic garden sprayer) over every inch of the car. The more, the better. Then you can let your car air dry even in the direct sunlight. It will dry spot free and shiny – all without having to wipe it off and risk scratching the finish. It’s almost a miracle and worth the effort. Your car will even retain its fine finish longer.

Section 1

Installation & Start-up Procedures

Installation Steps and Start-Up Procedures

AVOID COMMON MISTAKES !

Review the most common missed steps made BEFORE starting. This will ensure an easy and successful installation.

1. Prepare and install all service components such as RO faucet, drain saddle, and primary shut-off valve before installing the **WOW RO System** (Pages 28-30).
2. Fully pre-fill filter cartridges according to (Step 3, Page 13) to remove all air before attaching to system.
3. When installing pre-filled filters to system, you **MUST** make sure they are properly attached and engaged to the stop tabs per Step 3 (Figure 3b, Page 13) instructions. Filters are labeled PRE, POST and RO. Ensure each filter matches position on RO system manifold. (Figure 3b, and 3c, Page 13).
4. **Refrigerator/Icemakers and any other appliances beyond the primary faucet:** You must install a ball valve (isolation valve) isolating any added appliance beyond the primary faucet. (See Figure 5, Page 17). Valve must be in the closed or off position during the Start-Up Procedure. (See Step 5, Page 15).
5. Before beginning Start-up Procedures (Step 5, Page 15) make sure all tube connections match the Figure 1 diagram on Page 3.
6. Make sure system is **ONLY** connected to a cold water supply (Step 1, Page 9).
7. If your connections to and from the **WOW RO System** have a leak (even one drop), the system will not work. Repair leak (see Troubleshooting if necessary, Page 37) and repeat Start-up Procedures (Step 5, Page 15).
8. To avoid air-gap overflowing onto counter, air-gap return line must never have loops or sags in tubing.
9. If you are not using the WOW RO installation kit, it is critical that installers use correct color coded tubing (See installation kit contents, Page 10).
10. If replacing an existing RO system, make sure you replace all old tubing with new color coded tubing.

Installation Steps and Start-Up Procedures

Warning: Installation of this appliance must conform with state and local plumbing codes, laws, regulations, and the instructions provided with this appliance. Failure to install as instructed will void the product warranty.

Step 1 Pre-Installation Checklist

- Look under the sink to identify where the system will rest.
- To identify hot from cold, turn on hot water at the sink until hot water is flowing. Touch pipes below and mark cold from hot.
- Identify desired location for the new faucet and mark sink for drilled hole, unless hole is pre-existing.
- Review tool kit supplies needed (Table 1).
- Open box and confirm 3 filter cartridges (PRE, POST & RO), 1 RO system (tank & manifold) and installation kit (if purchased *).

*** If installation kit is not purchased, you will need:**

- 3— 4' x 1/4" tubing
- 1— 3/8" Drain saddle (sized for air-gap or non air-gap)
- 1— 3/8" tubing if air-gap is desired
- 1— Primary Shut-Off Valve
- 1— 1/4" WOW RO Secondary Shut-Off Valve
- 1— Faucet with appropriate connector to 1/4" tubing

Recommended Tool List	Professional Installers "Must Have" Tool List
Relton drill 1-1/4" assembly (HST-20) (porcelain sinks)	2 pressure gauges adapted to 1/4" tube
Greenlee 1/2" to 1-1/4" punch (stainless steel sinks)	Conductivity or TDS meter
1" to 1-1/4" Carbide drill bit or hole saw	Tubing cutter or sharp knife
7/16" open-end wrench	
1/2" open-end wrench	
9/16" open-end wrench	
5/8" open-end wrench	
Medium-sized (#2) Phillips screwdriver	

Table 1:
Recommended Tool List

Installation Kit Contents



Installation Kit Legend

- A. Non air-gap faucet
- B. Air-gap faucet
- C. Non air-gap faucet hardware
- D. Air-gap faucet hardware
- E. Drain saddle—(1/4")
- F. Drain saddle—(3/8")
- G. 1/4" WOW RO Secondary Shut-Off Valve
- H. Primary Shut-Off Valve
- I. Tubing for install connections:
 - Black 3/8" - Air-gap return line to 3/8" drain saddle
 - Black 1/4" - Air-gap drain feed to faucet/D port to non air-gap drain saddle
 - Red 1/4"
 - Blue 1/4"

Installation Steps and Start-Up Procedures

Step 2 Inspect System Parts from Box

Cartridge Inspection:

- Remove red cap on pre-filter and post-filter.
 - Confirm that external large O-Ring is in place.
 - Confirm that 2 smaller O-Rings are in place (located in center).
- Remove red cap on RO-membrane.
 - Confirm that large external O-Ring is in place.
 - Confirm that medium O-Ring is in place.
 - Confirm that 2 small O-Rings are in place (located in center).
- If any O-Rings are missing, please call our service center: (866) 790-8911 ext: 4

Proper Placement of Filters

Caution:

Cartridges must line up with tank cutouts when present

Newer systems may not have cutouts

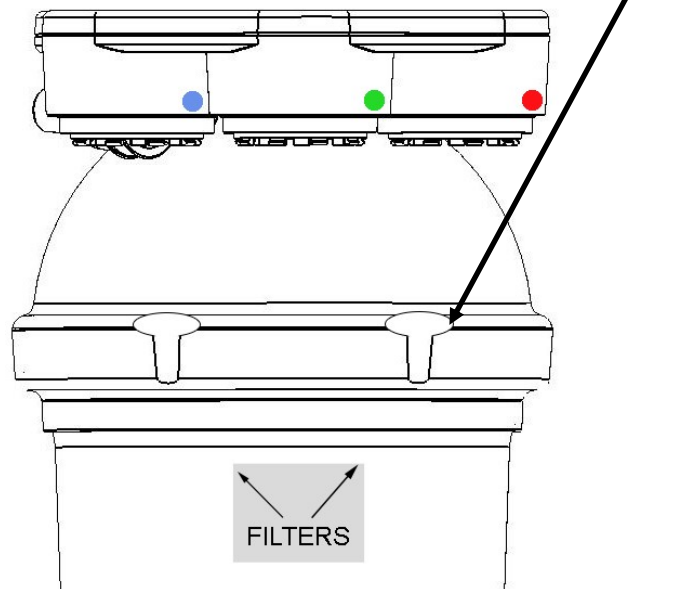

Figure 2:

Installation Steps and Start-Up Procedures

Step 3 Install Filtration & RO Membrane Cartridges

1. Remove the red cap from top of the filter & RO membrane cartridges.
2. With a black permanent marker, write the date on each filter to track replacement time. Pre and post filters last up to a year. RO cartridge may last longer (see Page 33).
3. Pre-fill all the cartridges with bottled water or tap water until they overflow from the top. Wait 3 minutes and top off as cartridges soak up water. Repeat until all cartridges are completely saturated and no air is present at the top.

Figure 3a:

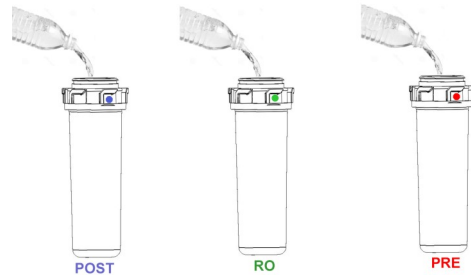

4. Attach post-filter in the labeled POST position, RO membrane in the labeled RO position and the pre-filter in the labeled PRE position, with a twisting counter clockwise upward motion until you feel and hear stop tabs touch and colored dots are aligned (see Figure 3).

Figure 3b:

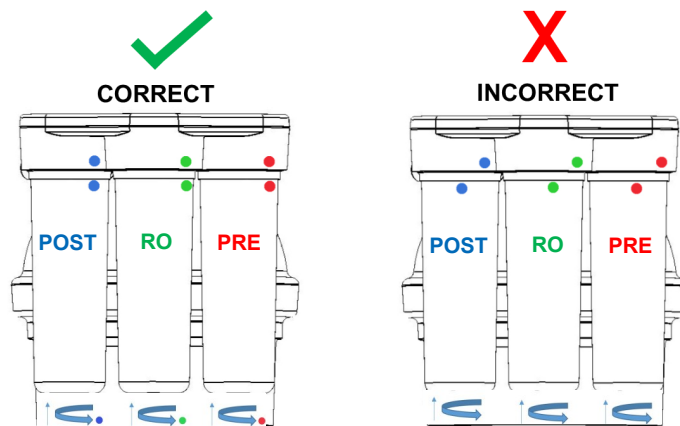
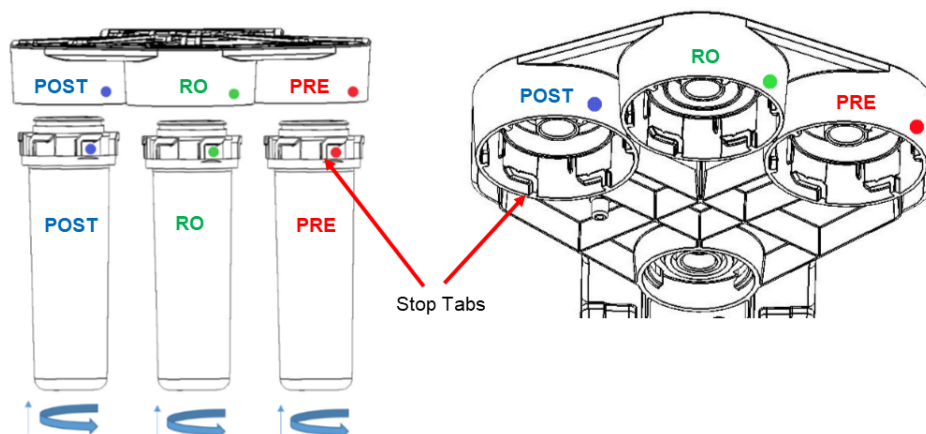

Figure 3c:



Warning: Check to see if the cartridges are fully engaged. Visually confirm colored dots are lined up and white cartridge stop tabs are flush with black manifold stop tabs prior and after pressurization of system.

Installation Steps and Start-Up Procedures

Step 4 Connect the System

WOW RO System port identification markings molded into the top of the manifold: (See Figure 4).

- **F:** Feed (¼" red)
- **D:** Drain (¼" black)
- **FA1:** Faucet/Accessory 1 (⅜" blue)
- **FA2:** Faucet/Accessory 2 (¼" blue)
- **PW:** Used for testing or additional storage.
- **SQ:** Used for testing or additional storage.
- **RF:** Do not touch (pre-connected).

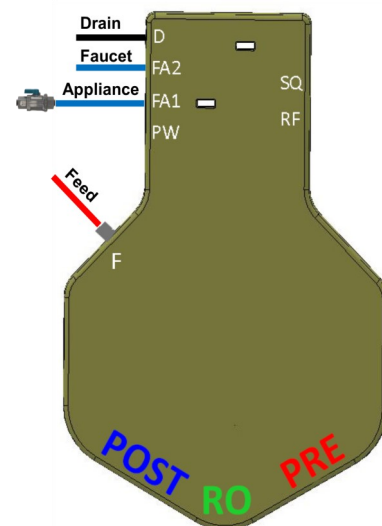

Figure 4:
System Connections

NOTE: Ports that are not used require the appropriate sized plug. (Included).

- With the **WOW RO System** in place, remove any port plugs as necessary (push in the white collet to release) and make the following connections:
- Feed F connection:** Take the 1/4" red tubing and snip off a 6" length. Take the long end of remaining tubing and attach it to the Primary Shut-Off Valve (cold water supply). Attach other end to the **WOW RO System** Secondary Shut-Off Valve (in installation kit). With the 6" tubing, attach one end to the **WOW RO System** Secondary Shut-Off Valve and the other end to the gray "F" port (See Figure 1, Page 3: Installation Diagram).
- Drain D connection:**
 - Air-Gap Faucet**
Route the free end of the 1/4" black tubing attached to the RO faucet air-gap to the connection marked "D". Air-gap faucet, (See Figure 12, Page 29).
 - Non Air-Gap Faucet ***
Route the drain line connection (saddle clamp or other) to the connection marked "D", using the 1/4" black tubing.
- RO Faucet connection:**
FA1 (3/8") or FA2 (1/4") If there are no additional appliances (i.e. refrigerator/icemaker, coffee maker, cooler, etc.) to install then you have the choice of using either port for the RO faucet.
 - If the RO faucet is more than ten feet in distance from the **WOW RO System**, then the 3/8" FA1 port is preferred.
 - Use the 1/4" FA2 port for the RO faucet and the 3/8" FA1 port for refrigerators/icemakers etc.

Note: For connecting a REFRIGERATOR/ ICEMAKER, you MUST add a ball valve (isolation valve) to properly initiate the start-up. See Section 2, Pages 16-23.

Installation Steps and Start-Up Procedures

Step 5 Start-up Procedure

Before the **WOW RO System** is operational, it must be properly primed by removing all air from the system.

Starting the WOW RO System:

- A. Make sure the RO faucet and refrigerator ball valve (isolation valve) is CLOSED.
- B. Turn the Primary Shut-Off Valve and Secondary Shut-Off Valve on. Notice the sound of water filling the system.
- C. Within 3-4 minutes, the waste line from the system will open with a noticeable exhaust of air and water.
- D. After waiting another minute, open the RO faucet. Notice air/water exhausting from faucet port. Wait for a steady stream of water and then CLOSE the faucet. (Refrigerator isolation valve still closed).
- E. Within 2 minutes, the waste port will open again with a shot of air/water exhausting. This can be witnessed by by-passing the drain saddle and directing the flow of the "D" line into a bucket. If the waste line stops within 2 to 3 minutes, repeat Step D & E, until the flow from drain is steady. If not, check for leaks on FA Line. You should notice a solid flow from the "D" Line. Place the tube back into Drain Saddle. System should fill to a full status within 45 to 90 minutes. (See Note 1).
- F. The system should be full, indicated by no audible or visible drain flow. Open the RO faucet and empty the system to a trickle. (Refrigerator isolation valve still in closed position).
- G. Turn off the RO faucet and let the water make-up process refill the tank.
- H. Repeat this process (Steps F & G) **three (3) times** to completely prep and flush the filter cartridges and ensure the operation of the system is stabilized. The refrigerator/icemaker ball valve (isolation valve) must be closed during this process and can only be opened when system is full for the final time. Next, you must follow procedures for bleeding lines, (Page 18).
- I. System is now fully operational! If the system does not work, refer to Troubleshooting Guide, (Page 37).
- J. To insure the highest quality water, it is recommended to drain the system once a week.

Note 1: If your connections along any FA lines have a leak (even one drop), the system will not work. Repair the leak and repeat Start-up Procedure. **Note 2:** See Pages 16-23 if adding any appliances. **Note 3:** Unlike traditional air charged RO systems, the WOW RO System will always have water in the tank, empty or full.

Section 2

Connecting Additional Appliances to WOW RO System

When connecting additional appliances to the **WOW RO System**, you must install a ball valve (isolation valve) isolating any added appliance beyond the primary faucet. (See Figure 5, Page 17). Valve must be in the closed or off position during the Start-Up Procedure. (See Step 5, Page 15).

There are many reasons why additional storage is required. If the system is installed in houses with larger families, cooking needs alone may warrant more storage. In addition, devices with larger storage capacities like coolers, will require greater draw down needs. Draw down refers to amount of water that is released when opening up the faucet and emptying the tank from start to finish (single pull). A standard **WOW RO System** holds 1½ gallons. The **WOW RO System** has been designed in a modular format to add additional storage tanks as needed. (See Sizing Chart, Page 17).

Connecting to Multiple Appliances

The **WOW RO System** is uniquely designed to connect to one or more appliances (Figure 5), including refrigerator icemakers and door dispensers, coolers (both gravity fed and pressurized), under-the-counter hot & cold vented systems, commercial steamers (restaurants), commercial and coffee makers, and other appliances that benefit from RO water. This section addresses “Do’s and Don’ts” of connecting to one or more appliances. It also addresses how to determine storage and expansion needs depending on how many appliances are hooked up.

General MUST Do’s for connecting ANY additional appliances:

- A. It’s a must that the filter and water lines to any and all added outlets be clear of air. Note: System will not work with air in the lines.
- B. Close the isolation valves to all additional outlets.
- C. Charge the system to its full status (refer to Start-up, Page 15).
- D. Follow the instructions provided from Pages 16-23.

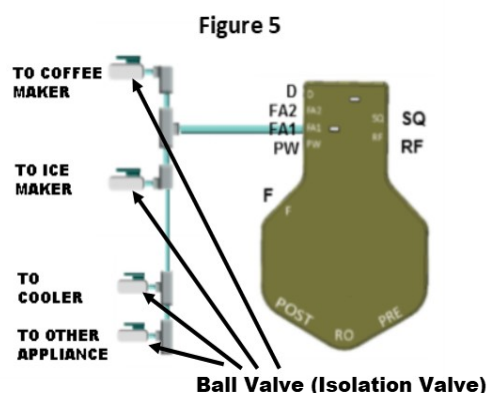

Determining Your Expansion and Storage Needs:

A standard **WOW RO System** holds 1½ gallons. The **WOW RO System** has been designed in a modular format to add additional storage tanks as needed.

Review the chart below for each device connected. Add all additional tanks needed from right hand column to determine the complete storage needs.

Device	Average Reservoir in Gallons *	Estimated Additional Tanks Needed
Refrigerator / Icemaker	0 gallons	None
Commercial Coffee Maker	1 gallon	0-1 Depending on draw down needs at peak periods (See Page 16 for draw down definition). Count glass/cups per hour to determine if greater than 1 gallon.
Gravity Cooler	Up to 3 gallons	1
Pressurized Cooler	Up to 3 gallons	1
Vented Hot Box	2/3 of a gallon or 84 oz.	0

* Check device manual for actual reservoir capacity.

Adding a Refrigerator/Icemaker

Refrigerator Hook-ups: (Figure 7, Page 19)

Adding a line from the **WOW RO System** to your refrigerator will provide you with clean tasting water and clearer, harder ice cubes.

Adding a refrigerator to a new WOW (dry) installation:

- Remove the 3/8" plug from the FA1 port by pushing on the white collet, releasing the plug.
- Connect the 3/8" plastic tubing to the FA1 port that goes to the icemaker.
- Make sure that a 3/8" Isolation/Shut-off Valve is installed at the system in the refrigerator/icemaker line and easily accessible under the sink cabinet (Figure 6).
- Close the Isolation Valve.
- Go to Start-up Procedures (Page 15) and proceed until fully operational.
- When system is full after conditioning, open the isolation valve and bleed the line to the refrigerator/icemaker as described below (Bleeding Lines).

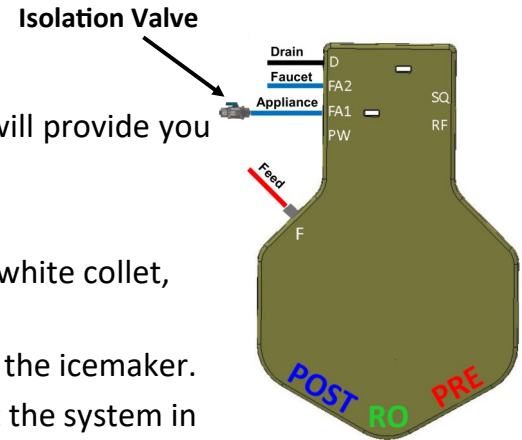

Figure 6

Adding a refrigerator to a pre-installed WOW (wet) installation:

- Close the Primary Shut-Off Valve.
- Open the faucet to relieve pressure on the FA ports.
- Remove the 3/8" plug from the FA1 port by pushing on the white collet, releasing the plug.
- Connect the 3/8" plastic tubing to the FA1 port that goes to the refrigerator/icemaker.
- Make sure that a 3/8" isolation/shut-off valve is installed at the system in the refrigerator/icemaker line and easily accessible under the sink cabinet (Figure 6).
- Close the Isolation Valve.
- Turn on the Primary Shut-Off Valve.
- Open the Isolation Valve.
- Bleed the line to the refrigerator/icemaker as described below (Bleeding Lines).

Bleeding Lines:

Refrigerator with no door dispenser:

- Open refrigerator isolation valve. System must be in full status.
- Open up the freezer and clear the ice cube tray.
- Push the lever down to engage ice-making. This will begin clearing air out of line.

Refrigerator with door dispenser:

- Open refrigerator isolation valve. System must be in full status.
- Use a glass to engage water dispensing and wait for a solid stream of water to clear the lines of air. When no air is present, stop dispensing.

Adding a Coffee Maker

Commercial Coffee Maker Hook-Ups: (Figure 8A, Page 23)

Adding a line from the **WOW RO System** to a commercial coffee maker will ensure RO water is always being used to create great tasting coffee and reducing or eliminating scaling.

Adding a coffee maker to a new WOW (dry) installation:

- Remove the 3/8" plug from the FA1 port by pushing on the white collet, releasing the plug.
- Connect the 3/8" plastic tubing to the FA1 port that goes to the coffee maker, and a second line with ball valve to FA2 for a sampling/faucet port.
- Make sure that a 3/8" isolation/shut-off valve is installed at the system in the coffee maker line and easily accessible under the sink cabinet (Figure 6).
- Close the Isolation Valve.
- Go to Start-up Procedures (Page 15) and proceed until fully operational.
- When system is full after conditioning, open the isolation valve and bleed the line to the coffee/expresso machine by brewing a pot.

Adding a coffee maker to a pre-installed WOW (wet) installation:

- Close the Primary Shut-Off Valve.
- Open the faucet to relieve pressure on the FA ports.
- Remove the 3/8" plug from the FA1 port by pushing on the white collet, releasing the plug.
- Connect the 3/8" plastic tubing to the FA1 port that goes to the coffee.
- Make sure that a 3/8" isolation/shut-off valve is installed at the system in the coffee maker line and easily accessible under the sink cabinet (Figure 6).
- Close the Isolation Valve.
- Turn on the Primary Shut-Off Valve.
- Open the Isolation Valve.
- Bleed the line to coffee maker as described below (Bleeding Lines).

Bleeding Lines:

Brew a pot of coffee.

Isolation Valve

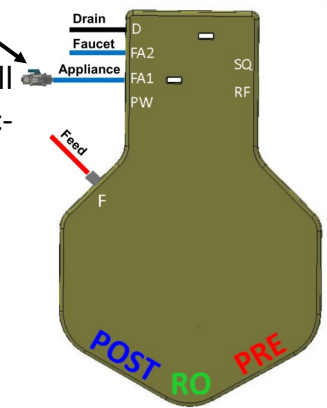

Figure 6



Adding a Cooler

Water Cooler Hook-ups: (Figure 8A, Page 23)

Adding a line from the **WOW RO System** to a cooler will ensure the RO water is always being used to create great tasting water. When adding devices with larger storage capacities, like coolers, you must first determine draw down needs.

Refer to Section 2, Page 16-17, "Determining your Expansion Needs".

Adding a cooler to a new WOW (dry) installation:

- Use FA1 or FA2.
- Connect FA1 or FA2 plastic tubing to the cooler.
- Make sure that a 3/8" or 1/4" isolation/shut-off valve is installed at the system in the cooler line and easily accessible under the sink cabinet (Figure 6).
- Close the Isolation Valve.
- Go to Start-up Procedures (Page 15) and proceed until fully operational.
- When system is full after conditioning, open the isolation valve and bleed the line to the cooler.

Adding a cooler to a pre-installed WOW (wet) installation:

- Close the Primary Shut-Off Valve.
- Open the faucet to relieve pressure on the FA ports.
- Remove the 3/8" plug from the FA1 port by pushing on the white collet, releasing the plug.
- Connect the 3/8" plastic tubing to the FA1 port that goes to the cooler.
- Make sure that a 3/8" isolation/shut-off valve is installed at the system in the cooler line and easily accessible under the sink cabinet (Figure 6).
- Close the Isolation valve.
- Turn on the Primary Shut-Off Valve.
- Open the Isolation Valve.
- Bleed the line to the cooler as described below (Bleeding Lines).

Bleeding Lines:

Open the Spigot to dispense water and wait for a solid stream of water.

Pressurized Cooler



Gravity Cooler

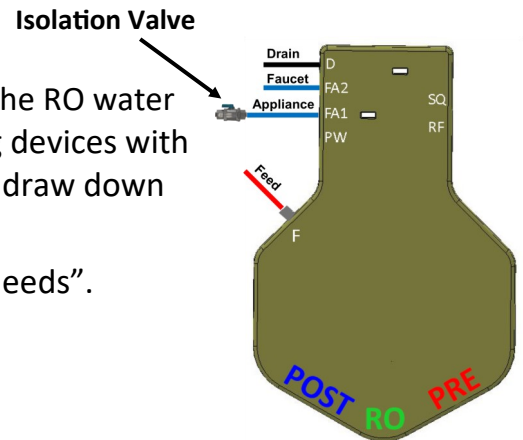

Figure 6

Adding a Hot Tank w/ Vented Faucet

Hot Tank Hook-ups: (Figure 8-B)

Adding a line from the **WOW RO System** to a hot tank will ensure the RO water is always being used to create great tasting hot water. When adding devices with larger storage capacities, like hot tanks, you must first determine draw down needs.

Refer to Section 2, Page 16-17, "Determining your Expansion Needs".

Adding a hot tank to a new WOW (dry) installation:

- Use FA1 or FA2.
- Connect FA1 or FA2 plastic tubing to the hot tank.
- Make sure that a 3/8" Isolation/Shut-off Valve is installed at the system in the hot tank line and is easily accessible under the sink cabinet (Figure 6).
- Close the Isolation valve.
- Go to Start-up Procedures (Page 15) and proceed until it is fully operational.
- When system is full after conditioning, open the isolation valve and bleed the line to the hot tank.

Adding a hot tank to a pre-installed WOW (wet) installation:

- Close the Primary Shut-Off Valve.
- Open the faucet to relieve pressure on the FA ports.
- Remove the 3/8" plug from the FA1 port by pushing on the white collet, releasing the plug.
- Connect the 3/8" plastic tubing to the FA1 port that goes to the hot tank.
- Make sure that a 3/8" isolation/shut-off valve is installed at the system in the hot tank line and easily accessible (Figure 6).
- Close the Isolation Valve.
- Turn on the Primary Shut-Off Valve.
- Open the Isolation Valve.
- Bleed the line to hot tank as described below (Bleeding Lines).

Bleeding Lines:

Open the RO faucet to dispense water and wait for a solid stream of water.

(See Hot Tank Manual for any additional requirements).

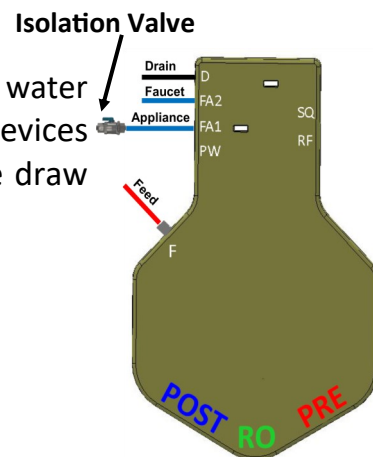

Figure 6



Figure 8-A
Ice-maker, Coffee-maker, Water Cooler



Figure 8-B
Hot Tank, Vented Faucet Installation

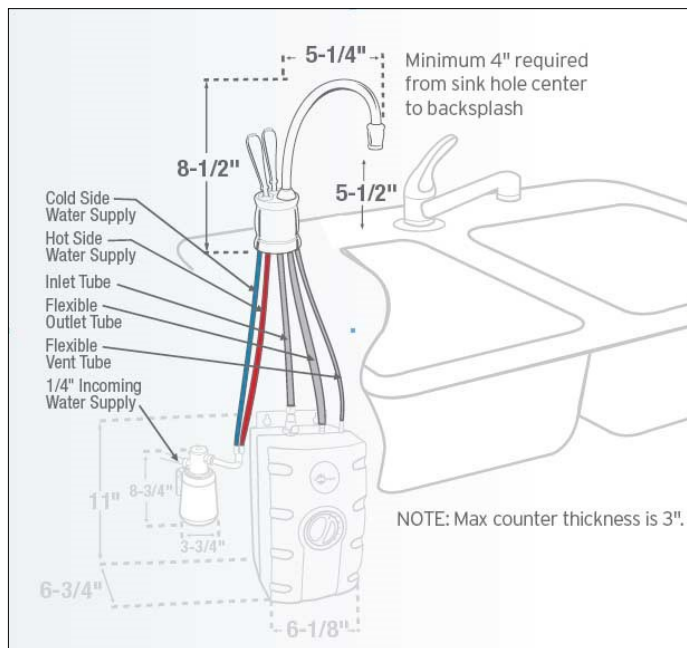

Section 3

When More Water is Needed

There are many reasons why additional storage is required. If the system is installed in houses with larger families, cooking needs alone may warrant more storage. If the family fills their water bottles exceeding 1½ gallons at the same time, additional storage will be required. In addition, devices with larger storage capacities like coolers will require greater draw down needs. Draw down refers to amount of water that is released when opening up the faucet and emptying the tank from start to finish (single pull). A standard **WOW RO System** holds 1½ gallons. The **WOW RO System** has been designed in a modular format to add additional storage tanks as needed. Review the chart below for each device connected. Add all additional tanks needed from right hand column to determine complete storage needs.

Device	Average Reservoir in Gallons *	Estimated Additional Tanks Needed
Refrigerator / Icemaker	0 gallons	None
Commercial Coffee Maker	1 gallon	0-1 Depending on draw down needs at peak periods (See Section 3, Page 24 for draw down definition). Count glass/cups per hour to determine if greater than 1 gallon.
Gravity Cooler	Up to 3 gallons	1
Pressurized Cooler	Up to 3 gallons	1
Vented Hot Box	2/3 of a gallon or 84 oz.	0

* Check device manual for actual reservoir capacity.

When More Water is Needed / Desired

Steps to determine storage needs: See Section 2, Page 17

Adding extra storage tanks:

- Open the RO faucet and drain off at least a couple cups of water to release pressure on the internal bladder.
- Wait until you hear the pressure release from the drain line.
- Turn off the Feed Valve.
- Remove the ¼" plugs from the SQ (Squeeze) and PW (Tank, Product Water) ports by pushing in the white collet to release.
- Connect ¼" yellow tubing between the matching SQ ports on the **WOW RO System** manifold and the spare tank adapter connected to the spare tank (See Figure 9 below for one or multiple tank set-ups).
- Connect ¼" green tubing between the matching PW ports on the manifold and the adapter (See Figure 9 below for one or multiple tank set-ups).
- After connections are completed, turn on the Primary Shut-Off Valve and open the faucet. You will hear a combination of air and water eliminated from system. Leave it open until a solid stream of water dispenses.
- Close the faucet.
- In less than a minute, the CPU Valve will activate and the system will resume making water with a noticeable exhaust of air and water down the drain.
- To expel all of the air from the newly added tank, it may be necessary to draw water from the faucet several times.

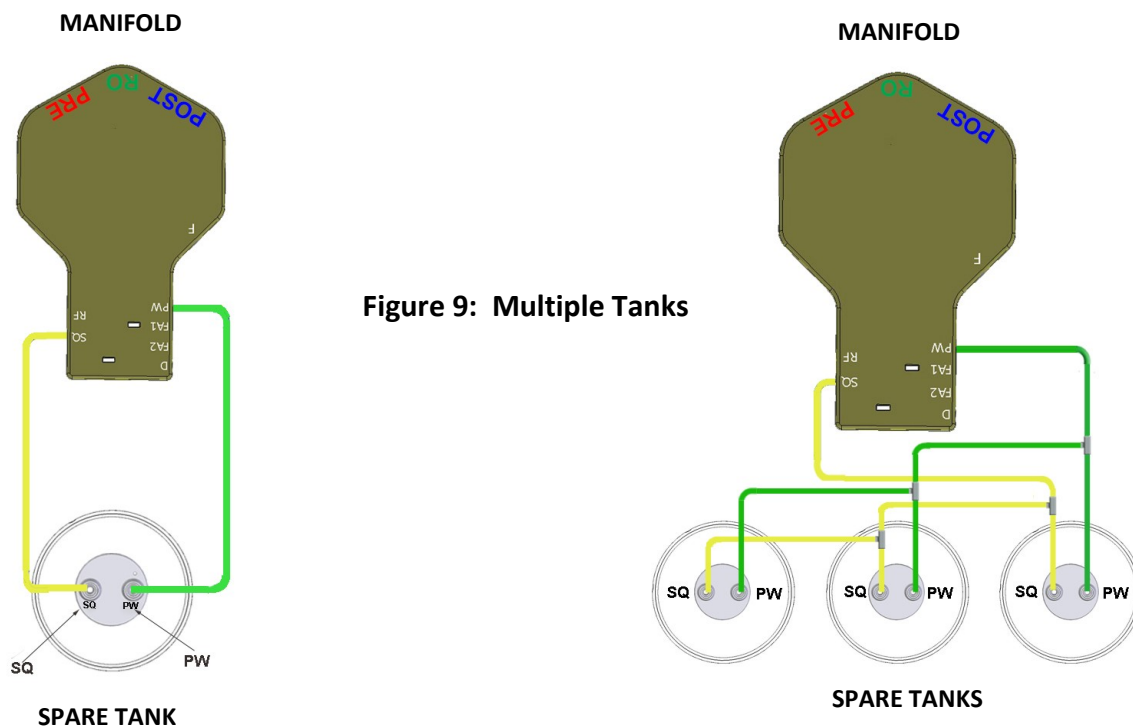
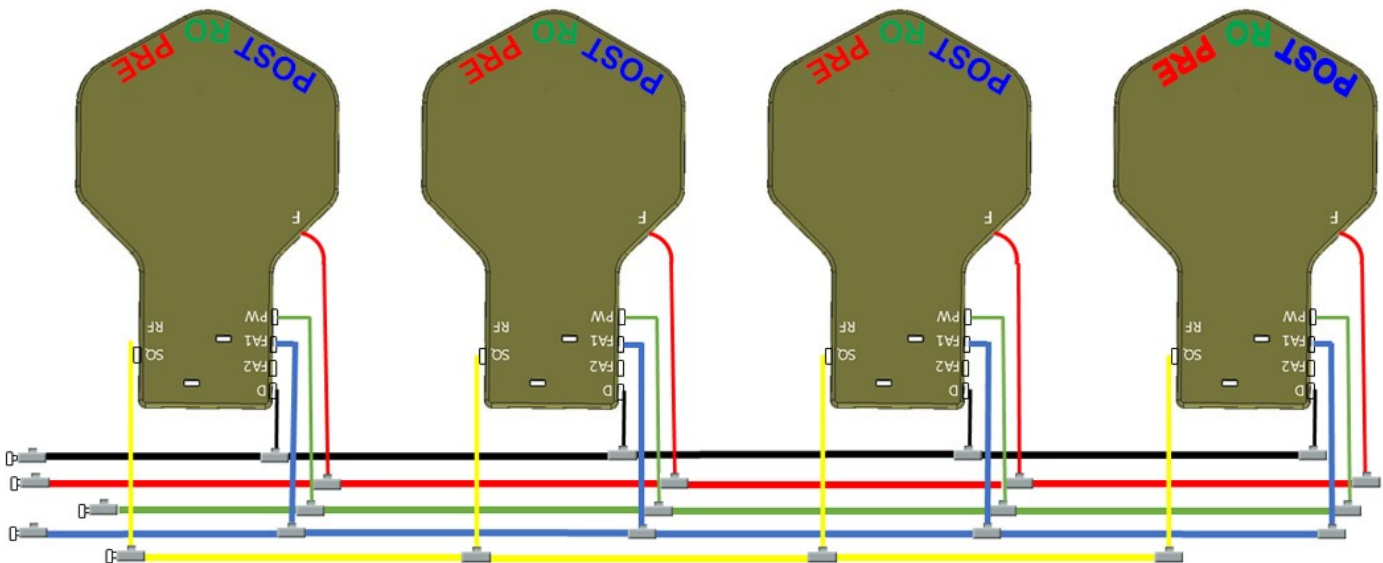
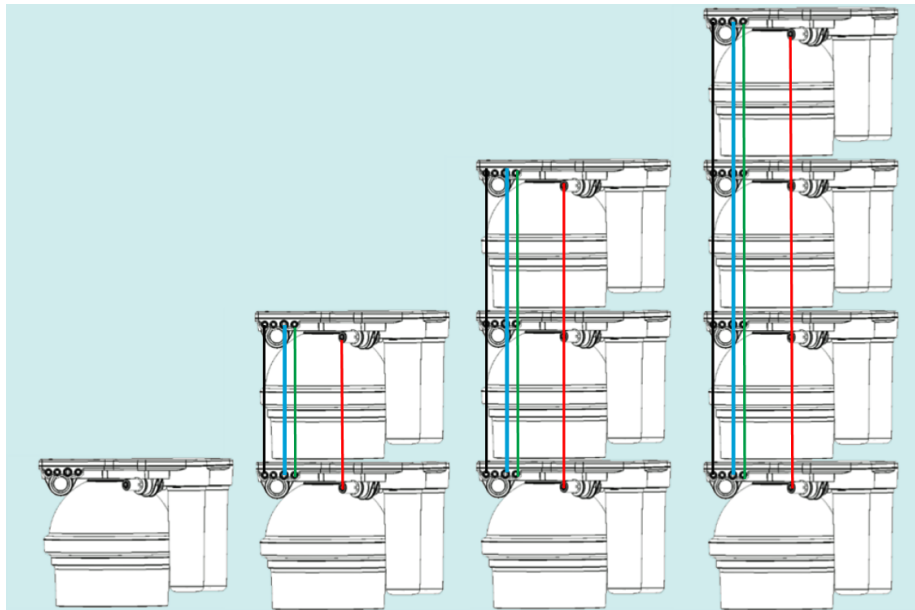

Figure 9: Multiple Tanks

Modular Expandability

Parallel Processing:



Section 4

Plumbing the Sink

Install the Drain Saddle Assembly

The drain saddle assembly should be installed above the P-trap on the vertical or horizontal tail-piece (See Figure 10 below). Use the black 1/4" saddle for the non air-gap RO faucet, or the white 3/8" saddle for the air-gap RO faucet.

- A. Position the drain saddle in the desired location, mark the spot to be drilled, and remove the saddle. (See Figure 10).
- B. Drill a 7/16" hole through one side of the drain pipe only.

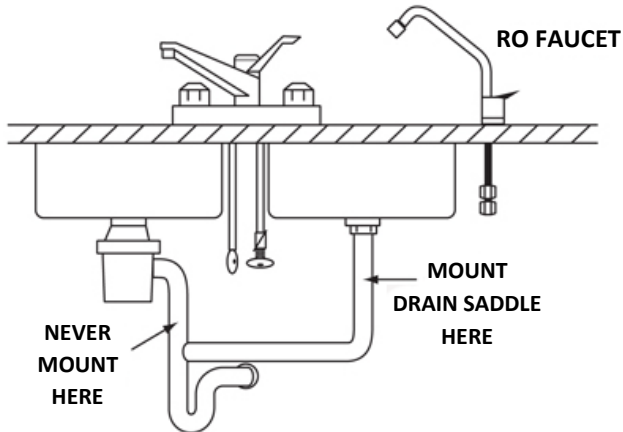

Figure 10:
Drain Saddle Assembly Mounting
Locations

- C. Peel off the paper backing from the drain gasket and apply the gasket to the "port" connection of the drain saddle (See Figure 11).
- D. Make sure to align the drain saddle to the drilled hole (use a small screwdriver to check the alignment).
- E. Attach the drain saddle to the drain pipe and tighten the two screws evenly.
- F. Cut the 1/4" tube or 3/8" tube to the desired length and connect to the drain saddle with the provided locking clip.

Note: State and local plumbing codes may prohibit the use of saddle valve connections.

Reminder: Must not have loop or sag in the drain saddle line as this will cause an overflow through the air-gap.

Figure 11: Drain Saddle Assembly



Prepare the RO Faucet for Installation

The most convenient installation will allow the use of an existing spray attachment or soap dispenser hole. If either hole is not available, then follow the basic procedures outlined below.

Drilling a stainless steel sink:

- A. Mark the sink location for the center of the spigot.
- B. Impact punch the sink top to provide a starting point for the drill bit.
- C. Drill a 1/4" pilot hole in the sink using a high-speed drill bit.
- D. Drill a 1/2" diameter hole to accept the bolt of a 1" Greenlee Chassis Punch.
- E. Set the punch and turn the nut with a wrench to cut the hole. Follow Greenlee instructions.

Drilling a porcelain clad steel or cast-iron sink:

Caution: Be careful when the drill is about to penetrate the base metal of the sink. Reduce the speed and support the drill so the drill chuck does not impact the porcelain or enamel.

- A. Position the faucet for customer convenience and then secure the faucet on the sink.
- B. Assemble the faucet with all of the components (See Figure 12, for typical air-gap and non air-gap faucet) pre-assembling both drain lines to the air-gap faucet.
- C. Feed the assembled faucet and tubing through the hole in the sink and fasten it from under the sink.
- D. Air-Gap return to drain; a 3/8" line must be installed with no loops or sags. It must be a direct shot to the drain.

Figure 12: Air Gap and Non-Air Gap Faucets

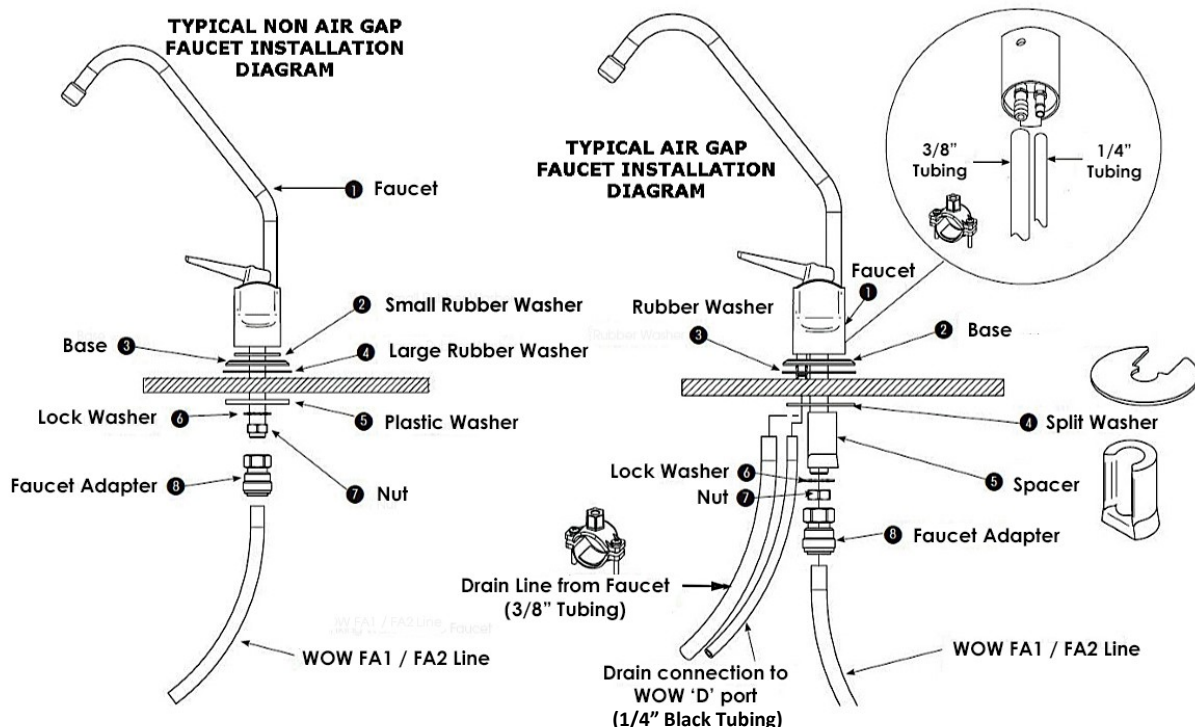

Install the Primary Shut-Off Valve

For installation with a standard Primary Shut-Off valve (See Figure 14).

- A. Shut off the water at the angle stop valve.
- B. Use a wrench to loosen the compression nut on the angle-riser tube/flex line to upper faucet.
- C. Install the Primary Shut-Off valve onto the angle stop. Use the wrench to tighten the compression nut on the Primary Shut-Off valve. **Do not overtighten.**
- D. Reconnect the riser tube to the other end of the Primary Shut-Off valve. **Do not overtighten.**

Caution: A longer riser tube assembly will be required if a gentle loop cannot be made. (See Figure 13).

- E. Fully insert the 1/4" tube into the speed-fit/John Guest-style connection. The new incoming water valve can be swiveled to position the tubing out of the way.
- F. Make sure the Primary Shut-Off valve is off before turning the angle stop valve on. Check for leaks.

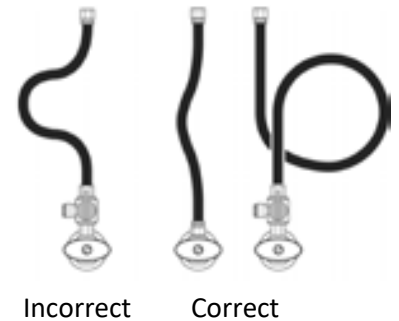

Figure 13:
Flexible Hose Positions

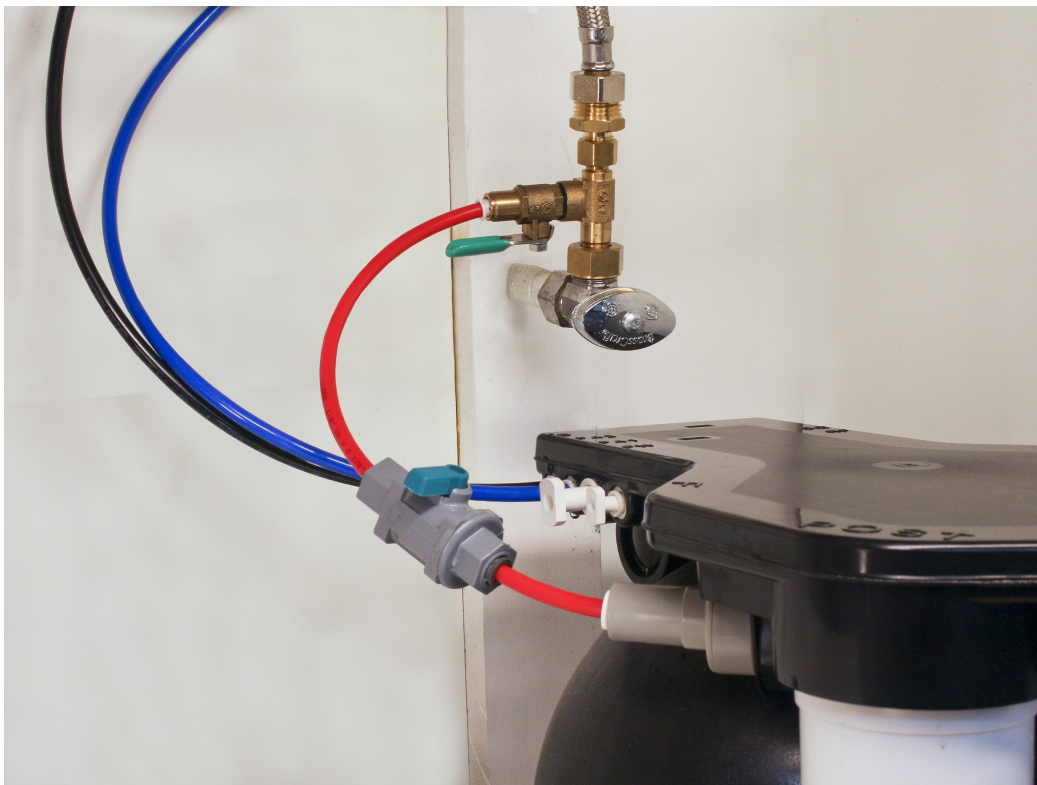

Figure 14: Installation with Flexible Hoses

Section 5

Maintenance

Changing Filters

Changing the Filter & RO Membrane Cartridges (PRE, RO, POST)

(Refer to Installation)

Removal

1. Pre-fill new cartridges with WOW RO water.
2. Open the RO faucet for a glass of water and close.
3. Turn off the System Feed Valve and wait for 20 seconds.
4. If the system is connected to a refrigerator/icemaker, close the Isolation Valve to that connection. Re-open the RO faucet.
5. The system has now been depressurized for a safe removal of the cartridges.
6. Towels should be placed under the system first.
7. Remove the cartridges with a clockwise upward twist.

Replacement

1. Remove red cap from the top of filter cartridges.
2. With a black permanent marker, write the date on each filter to track replacement time. For filter life, (See Page 33) and log filter change date on Page 43).
3. Attach the post-filter in the labeled POST position, the RO membrane in the labeled RO position, and the pre-filter in the labeled PRE position, with a twisting counter clockwise upward motion until the colored dots are aligned (See Figure 15).
4. Turn the system feed on.
5. Open the RO faucet to a solid flow and close. Do this a couple of times to expel any added air from filter change.
6. Turn on the refrigerator/icemaker valve and bleed air by operating the water dispenser or ice cube maker.

Note: Make sure your cartridges are inserted completely !

Figure 15: Changing Filter & RO Membrane Cartridges

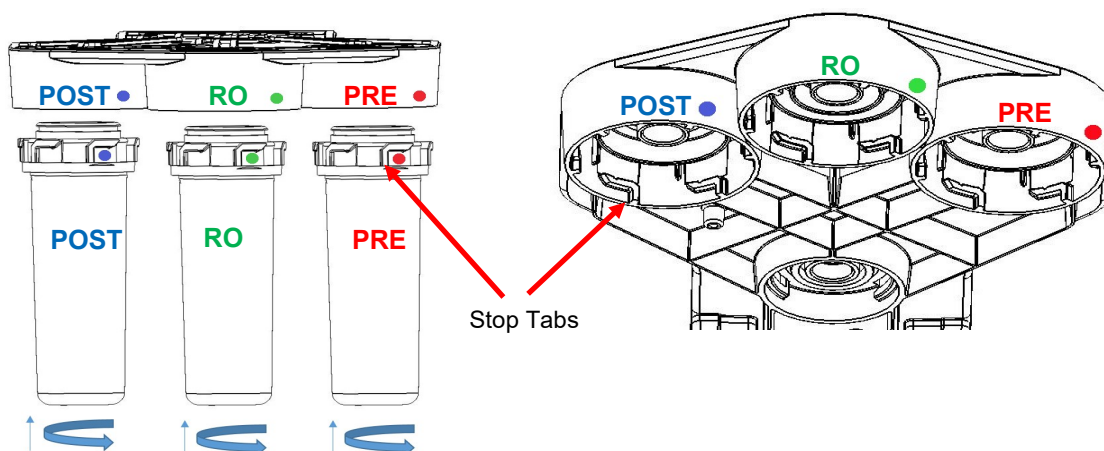

Recommended Filter Replacement

The frequency in which the membrane and filters should be replaced depends upon the quality of the water that enters the appliance. Contact your WOW Water specialist or visit www.wowwater.com for replacement filters and parts.

Note: The installation of the **WOW RO System** appliance on a pre-treated water supply will greatly increase the life of its filters.

Note: Any filter that demonstrates reduced water production or a slower rate of flow is overdue for a change.

Warning: Shut off water to the appliance before beginning any maintenance.

Filter	Recommended Replacement (Months)
Replacement of the Sediment/Carbon Pre-filter (RED) Part# 20-201-001	6-12
Replacement of the Reverse Osmosis Membrane (GREEN) Part# 20-250-001	12-24
Replacement of the Carbon Post-filter (BLUE) Part# 20-202-001	6-12

WOW RO System Appliance

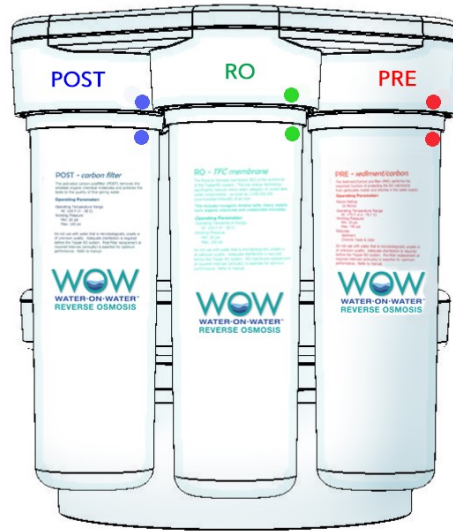

Figure 16: WOW RO System Appliance

1. **Replacement of the Sediment/Carbon Pre-Filter (RED)** - The Sediment/Carbon pre-filter (PRE) performs the important function of protecting the RO membrane from particulate matter and chlorine in the water supply.
2. **Replacement of the Reverse Osmosis Membrane (GREEN)** - The Reverse Osmosis membrane (RO) is the workhorse of the WOW RO system. This low energy technology significantly reduces nearly every category of undesirable water contaminants—as small as 1/100,000,000 (one hundred-millionth) of an inch. ***This includes inorganic mineral salts, heavy metals, toxic organic chemicals, and undesirable microbes.***
3. **Replacement of the Carbon Post-Filter (BLUE)** - The activated carbon post-filter (POST) removes the smallest organic chemical molecules.

WOW RO System Filter Labels

POST -carbon filter

The activated carbon postfilter (POST) removes the smallest organic chemical molecules and polishes the taste to the quality of fine spring water.

Operating Parameters

Operating Temperature Range: 40 -100 F (4 - 38 C) Working Pressure: Min: 20 psi Max: 100 psi

Do not use with water that is microbiologically unsafe or of unknown quality. Adequate disinfection is required before the WOW RO system. Post-filter replacement at required intervals (annually) is essential for optimum performance. Refer to manual.



WOWwater.com 866-790-8911
MADE IN THE USA
Removal of label voids warranty!

RO -TFC membrane

The Reverse Osmosis membrane (RO) is the workhorse of the TopperRO system. This low energy technology significantly reduces nearly every category of undesirable water contaminants - as small as 1/100,000,000 (one hundred-millionth) of an inch.

This includes inorganic mineral salts, heavy metals, toxic organic chemicals and undesirable microbes.

Operating Parameters

Operating Temperature Range: 40 -100 F (4 - 38 C) Working Pressure: Min: 20 psi Max: 100 psi

Do not use with water that is microbiologically unsafe or of unknown quality. Adequate disinfection is required before the WOW RO system. RO-membrane replacement at required intervals (annually) is essential for optimum performance. Refer to manual.



WOWwater.com 866-790-8911
MADE IN THE USA
Removal of label voids warranty!

PRE -sediment/carbon

The Sediment/Carbon pre-filter (PRE) performs the important function of protecting the RO membrane from particulate matter and chlorine in the water supply.

Operating Parameters

Operating Temperature Range: 40 - 100 F (4 - 38 C) Micron Rating: 10 Micron

Working Pressure: Min: 20 psi Max: 100 psi Reduces: Sediment Chlorine Taste & Odor

Do not use with water that is microbiologically unsafe or of unknown quality. Adequate disinfection is required before the WOW RO system. Pre-filter replacement at required intervals (annually) is essential for optimum performance. Refer to manual.



WOWwater.com 866-790-8911
MADE IN THE USA
Removal of label voids warranty!

Sanitize Water on Water

This can be performed at the time of the filter replacement.

Place a towel down under the system for spills. Also have a small bucket available.

1. With feed supply on, drain down about 60 seconds of water through the faucet, then close the faucet.
2. Giving it 10 seconds, the system should be de-pressurized by this time. The “PW/SQ” ports will not have any pressure.
3. Turn off supply to the “F” port.
4. Remove the “PW” and the “SQ” pins.
5. Install the Sanitizer Cannister (available online at www.wowwater.com) to the “PW” port, using a ¼” tube, making sure the cannister has the sanitizing solution (3% Hydrogen Peroxide) inside. (This is important).
6. Place ¼” tubing in the “SQ” port and direct the “SQ” exit into a bucket or pot.
7. Using the supply line to pressurize the sanitizer is best, so detach from the “F” port. Place into the sani-cup and turn on the supply for 10 seconds.
8. You are now ready to turn on the feed valve to the sanitizer. Water will immediately emanate from the “SQ” port into the bucket. Leave it on for about a liter/quart of water. You have now introduced a sanitizer to the product water bladder.
9. Next, remove sanitizer tube from the “PW” port. Disengage the Feed Line from the Sanitizer Unit and place back into the “F” port. Plug in the “PW” port. Remove the “SQ” exhaust line and place the plug back in the “SQ” port.
10. Leave the Sanitizing Solution in the system for about 2 hours, then open the faucet and drain the system until empty. Then let the system fill on its own.

Recommended Literature

For comprehensive and detailed information on all aspects of installing POU RO systems, we recommend purchasing **Reverse Osmosis—"A Practical Application Manual for Residential Point-of-Use Systems"** by Robert Slovak, one of the members of the *TOPPER* development team. This publication can be purchased from the Water Quality Assn. (www.wqa.org) bookstore.

Go to www.wowwater.com for installation tips & videos of the **WOW RO System**.

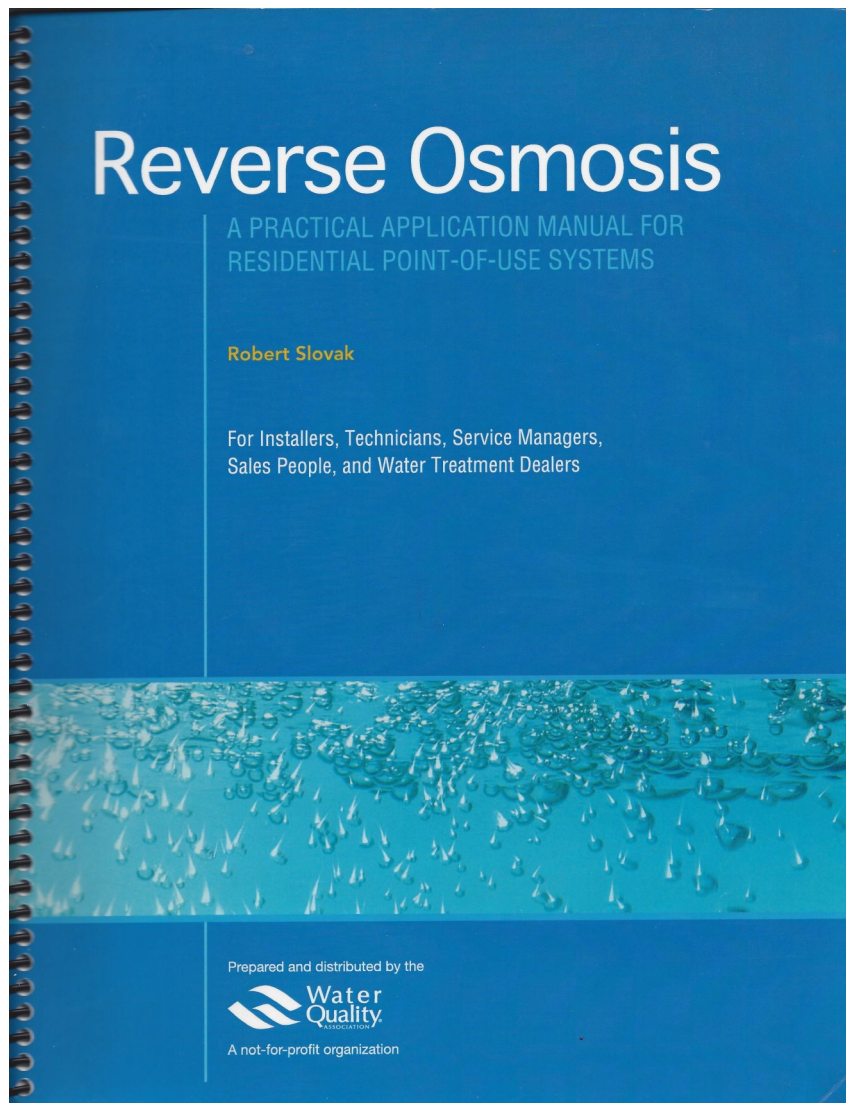

Section 6

Troubleshooting

Troubleshooting

PROBLEM	REASON	SOLUTION
System will not make water.	<ul style="list-style-type: none"> • Refrigerator ball valve (isolation valve) not closed or needs to be installed in the closed position. • Not enough feed water pressure. • Feed valves are closed. • Tubing may be connected to wrong port. • TDS may be too high • Water temperature too low 	<ul style="list-style-type: none"> • Close isolation valve or needs to be added as described in Section 1, Pages 14 & 15 and Section 2, Pages 16-22, and follow procedure. • House regulator may need to be increased or add a pump. • Primary Shut-Off Valve, Secondary Shut-Off Valve, Angle stops. • See Page 14 connection. • Out of spec • Out of spec.
System has a trickle of water from faucet and has never initiated to a high flow volume.	<ul style="list-style-type: none"> • Refrigerator ball valve (isolation valve) not closed or needs to be installed in the closed position. • Leak down line of FA Ports. • Exceeding storage capacity. Current storage insufficient. 	<ul style="list-style-type: none"> • Close isolation valve or needs to be added as described in Section 1, Pages 14 & 15 and Section 2, Pages 16-22, and follow procedure. • Locate leaks and repair. • Revisit “When more water is needed”, Section 3, Page 24.
System is cycling on and off on its own with faucets closed.	<ul style="list-style-type: none"> • Air trapped in FA line or water leak. • Pre & Post filters are in the wrong locations. • Bad Internal check valve in post-filter. • Center “O” rings are missing in post filter. 	<ul style="list-style-type: none"> • Check for leaks on all FA lines. Close all Isolation Valves. If the problem stops, you have a leak down the FA line. Repair any leaks you may find. (SYSTEM WILL NOT FUNCTION WITH ANY LEAKS IN THE FA LINES). • Match filter with the proper position on RO system. • Change the post-filter. • Replace “O” rings or replace filter.

Troubleshooting

PROBLEM	REASON	SOLUTION
Water dispensing does not meet average flows.	<ul style="list-style-type: none"> • Not enough water pressure. • Pre-filter is plugged. 	<ul style="list-style-type: none"> • House regulator may need to be increased. If on a well, verify on/off pressure of well pump and increase. • Change filter. See Page 32.
Reduced dispensing of water from a remote location such as a spare RO faucet, refrigerator water dispenser or cooler.	<ul style="list-style-type: none"> • If RO water is dispensing from the primary faucet, then either the isolation valve to the remote location is closed or there is some tubing obstruction. 	<ul style="list-style-type: none"> • A combination of long distance from the WOW RO system and inadequate tubing size may prevent the CPU Valve from activating. Limit ¼" tubing to runs of 15' and use ⅜" tubing up to 50'. For even longer runs consider ½" tubing.
System making noise.	<ul style="list-style-type: none"> • Trapped air. 	<ul style="list-style-type: none"> • Close the isolation valves and wait until the system is full and shut down. Purge the lines until a steady flow and close faucet or appliance. See Pages 14-22, Ball Valve (isolation valve), Bleeding Lines.
Water leaking from the Air-Gap installation.	<ul style="list-style-type: none"> • Air-gap installation incorrect. • Clogged drain. 	<ul style="list-style-type: none"> • Remove loops or sags from Air-Gap to the drain. • Unclog the drain.
Small leaks at plugs.	<ul style="list-style-type: none"> • Internal "O" ring is off-set. 	<ul style="list-style-type: none"> • Rotate the plugs a few times. Check for leaks after a few minutes.
Small leaks from tube connections.	<ul style="list-style-type: none"> • Old tubing or tubing cut at an angle. 	<ul style="list-style-type: none"> • Cut 1" off the end of the tubing.
Leak at pre/post filter. (Filter fell off)	<ul style="list-style-type: none"> • Filter cartridge was not inserted correctly. 	<ul style="list-style-type: none"> • Insert and rotate to the stop tabs. See Page 13.
High TDS levels.	<ul style="list-style-type: none"> • The WOW RO System was not properly flushed prior to use. • Filters needs replacing. • TDS creep. 	<ul style="list-style-type: none"> • Follow guidelines in Start-up Procedure, Section 1, Step 5, Page 15. • See Page 32. • Empty and refill the tank once a week.

Owner Information

Safety Instructions

Warning: This appliance must be applied to potable water only. It is recommended that a water treatment specialist install and maintain this appliance.

Note: The manufacturer reserves the right to make specification and product changes without prior notice.

When installing the appliance into a local water supply, it is recommended to conduct a water analysis. If the water analysis does not correspond with the requirements, the lifetime of the filtration cartridges and the membrane unit may be significantly reduced. In this case, it is recommended to use auxiliary water treatment systems (e.g. mechanical filter, de-ionizing filter, and/or water softener). It is recommended to use only microbiological safe water with your **WOW RO System** appliance.

Caution: Do not use water that is microbiologically unsafe or is of unknown quality without an adequate disinfection before or after the appliance.

We recommend that you have your local treatment specialist service this appliance. Ensure that all items are checked when servicing the appliance.

For Online instructions, go to www.wowwater.com

OWNERS REGISTRATION CARD

PLEASE fill out this form when installation has been completed and return to

Topper Manufacturing Corp, 23880 Madison St. Torrance CA 90505 (310) 375-5000

Name:	_____		
Street Address:	_____		
City:	_____	State: _____	Zip: _____
Name of Water Service Company:	_____		
Purchased From:	_____		
Date of Purchase:	_____	Date of Installation:	_____
Serial Number:	_____	Model Number:	_____
Installation Company:	_____		
Technician:	_____	Telephone:	_____

2 Year Limited Warranty

TWO YEAR LIMITED WARRANTY WOW Water Reverse Osmosis System

For a period of 2 (two) years from the date of original installation, we will repair or replace any part of this Reverse Osmosis system that we find to be defective in operation because of faulty material or workmanship. You pay only freight to and from our factory and local labor charges. Warranty does not include filter cartridges and RO membrane. Available for replacement at www.wowwater.com.

General Provisions (or Conditions):

This warranty is void should any part of the Reverse Osmosis system be damaged due to misapplication, neglect, accident, alteration, or installation and operation, contrary to our printed instructions. Damage caused by freezing, flood, fire, or Acts of God are not covered by this warranty.

We assume no warranty liability in connection with this Reverse Osmosis System other than as specified herein. This warranty is in lieu of all other warranties, expressed or implied including warranties of fitness for a particular purpose. We do not authorize any person or representative to assume for us any other obligations on the use of the Reverse Osmosis system.

For this warranty to be valid, the following conditions must be met:

1. Microbiologically-safe water supplies.
2. pH cannot be lower than 3 or higher than 11.
3. Water temperature must be between 40° F (4.44° C) - 100° F (37.77° C).
4. Total dissolved solids cannot exceed 1500 ppm.
5. Supply line pressure min. 20 psi - 125 psi (1.38 - 8.62 Bar)
6. ALL SYSTEMS MUST BE ON COLD WATER LINES ONLY.

Any and all warranties will be immediately void if the labels or any part of the labels are removed or if original WOW RO replacement filters are not used.



Customer Service Notes

Filter Replacement Record	
Date	Filter
Installer/ Dealer	Filter
Notes:	

Filter Replacement Record	
Date	Filter
Installer/ Dealer	Filter
Notes:	

Filter Replacement Record	
Date	Filter
Installer/ Dealer	Filter
Notes:	

Filter Replacement Record	
Date	Filter
Installer/ Dealer	Filter
Notes:	

Filter Replacement Record	
Date	Filter
Installer/ Dealer	Filter
Notes:	



WOW

WATER-ON-WATER™ REVERSE OSMOSIS

WOW50-20-209-001

- Faster Easier Installation
- Compact size fits in half the space of other units
- Patented **water-on-water™** tank provides constant flow to the last drop
- Environment-friendly - uses up to 500% less waste water
- No air charge needed
- Patented manifold design increases reliability
- Patented CPU valve with only one moving part = higher reliability
- Operates as low as 20 psi
- Safe and convenient, **sanitary rapid-change** filters offer consumer friendly maintenance

Specifications	
Model:	WOW50-20-209-001
Temperature Range:	40° F (4.44° C) - 100° F (37.77° C)
Pressure Range:	20 - 125 psi (1.38 - 8.62 Bar)
System Production Rate:	30.5 gpd (113.56 Lpd)
Efficiency Rating:	27.50%
TDS Rejection:	95.40%
Dimensions:	14" x 9-1/2" x 10-1/2"
Weight:	10 Lbs

The installation of this RO System needs to comply with all Local and State Laws and Regulations



This WOW-50 RO System is Certified by IAPMO R&T against NSF/ANSI 58 for the reduction of Claims specified in the Performance Data Sheet

Efficiency rating means the percentage of the influent water to the system that is available to the user as reverse osmosis treated water under operating conditions that approximate typical daily usage

The Many Uses of WOW Water

- Cooking
- Juices & Mixes
- Coffee & Tea
- Ice Cubes
- Humidifiers
- Aquariums
- Low Sodium Diets
- Rinsing Hair Plants
- Steam Irons
- Windshield Wiper Fluid
- Automobile Batteries

Do not use with water that is micro-biologically unsafe or of unknown quality without adequate disinfection before or after the system. Systems certified for cyst reduction may be used on disinfected water that may contain filterable cysts.

Compact Size. Easier Install. More Reliable.



WOWwater.com

WOW Water Systems Performance Data Sheet V1.3.15.19

* Results may vary depending on water conditions

Topper Manufacturing Co.- A Beall Development - 23880 Madison Street, Torrance, CA 90505 - U.S. and foreign patents issued and pending.