



ACCOUNT # _____

Table of Contents

COMPANY INFORMATION

- Good Water Warehouse Locations 5
- Line Card (partial list)..... 6
- Order Form 8
- Credit Application..... 9
- Terms and Conditions of Sale..... 10

WATER SOFTENERS, POE EQUIPMENT & COMPONENTS

- Water Softener Equipment Sizing Chart..... 12
- Valumax™ Fleck™ Water Softeners 13
- Valumax™ Fleck™ Backwashing Filter Systems 16
- Fleck™ Valves 18
- Valumax™ Fleck™ Install Parts and Valve Accessories..... 19
- Fleck™ Parts and Service Accessories..... 20
- Valumax™ Autotrol™ Water Softeners..... 25
- Ultramax™ Water Softeners 27
- Valumax™ Autotrol™ Backwashing Filter Systems..... 28
- Valumax™ Autotrol™ Install Parts 29
- Autotrol® Valves 30
- Autotrol® Parts and Accessories..... 32
- Structural™ Media Tanks 34
- Structural™ Brine Tanks 35
- Neoprene Tank Jackets..... 35
- Risers, Baskets, Hub and Laterals 36
- Media & Resin 37
- Metsorb by Graver Technologies 38
- Softener Tubing..... 38
- Chemicals - Equipment Cleaners 38
- Mazzei® Injector Company - Injectors 40
- Rusco™ Filters 41

DRINKING WATER SYSTEMS

- FreshPoint Under Counter Reverse Osmosis System 46
- Pentek RO-2550 Reverse Osmosis System 46
- GR/O Reverse Osmosis System "The Water Saver" 47
- PRO LINE Reverse Osmosis System 48
- PureValue Reverse Osmosis Systems..... 49
- PuROTwist Reverse Osmosis Systems..... 50
- Semi Commercial RO Assemblies 51
- Counter Top Units..... 51
- Under Sink Filtration 52
- Point Of Entry Filtration 52
- Ultra Filtration System..... 52
- Commercial Reverse Osmosis Systems..... 53
- ESYBOX Systems 55



MEMBRANES & MEMBRANE HOUSINGS

Valutrex™ Membranes.....	58
Pentair® Residential Membranes.....	58
PuROTwist Membranes.....	58
Pentair GRO High Recovery (1:1 Ratio) Encapsulated Membranes.....	58
Hydrotech Membranes.....	59
Microline Membranes.....	59
Culligan Membranes [compatible].....	59
Eco Water Membranes [compatible].....	59
Rainsoft Membranes [compatible].....	59
Water Factory Membranes.....	59
VEOLIA Commercial Membranes.....	60
Filmtec™ Residential & Commercial Membranes.....	61
Global Aqua Membranes.....	62
CSM® Residential & Commercial Membranes.....	62
Pentair® Membrane Housings.....	63
CodeLine™ Commercial Membrane Housings.....	63
Stainless Steel Commercial Membrane Housings.....	63

HOUSINGS & FILTER CARTRIDGES

Pentair® Slimline Filter Housings [1/4", 3/8" & 1/2" Inlets].....	66
Pentair® Standard Filter Housings [3/4" inlets].....	67
Pentair® Big Blue [BB] Filter Housings.....	68
Pentair® Commercial Filter Housings.....	69
QMP® Housings.....	69
Harmsco® Stainless Steel Filter Housings.....	70
Harmsco® Sediment Filters.....	71
Unicel® Sediment Filters.....	74
United Sediment Filters.....	74
Dual Micron Poly Spun Sediment Filters.....	76
Valutrex™ Sediment Filters.....	76
Purtrex™ Sediment Filters.....	77
Hytrex™ Sediment Filters.....	78
Pentair® Sediment Filters.....	79
Pentair® Carbon Filters.....	80
Valutrex™ Carbon Block Filters.....	81
KX® Matrikx® Carbon Filters.....	82
Filtrex® Carbon Filters.....	84
Omnipure® Carbon Filters.....	85
Omnipure® CL-Series - Inline Filters.....	85
Omnipure® K-Series - Inline Filters.....	86
Omnipure® Q-Series - Twist Off Filters.....	88
Omnipure® L-Series - Twist Off Filters.....	90
Omnipure® E Series Filters.....	91
Omnipure® ELF Series Filters.....	93
Omnipure® ELF XL Series Filters.....	94
Omnipure® ELF EXT Cap Series Filters.....	94
Alkaline Filters.....	95
ResinTech® Specialty Filters.....	95
Pentair® Specialty Filters.....	97
Empty Refillable Cartridges.....	97
Eco Water Compatible Filter.....	98
Culligan Compatible Filters.....	98



HOUSINGS & FILTER CARTRIDGES CONTINUED...

Hydrotech Original & Compatible Filters	98
Merlin Original Filters.....	99
Microline Original Filters	99
PuroTwist Filters	99
Rainsoft Compatible Filters	99
Water Factory/CUNO SQC Original & Compatible Filters.....	100
H2O International® Shower Filters	100
QMP® Shower Filters	101
Sprite® Shower Filters	101

FITTINGS, R.O. & FILTER COMPONENTS

John Guest® Fittings	104
John Guest® Ball Valves	108
John Guest® Check Valves	108
John Guest® Brass Fittings	109
John Guest® Tube Cutter & Blades	109
John Guest® PE Tubing	109
John Guest® [ProLock] Softener / Large Diameter Fittings.....	110
AquaLock™ 10 Series Fittings	113
AquaLock™ Ball Valves.....	114
AquaLock™ Large Diameter Fittings	115
Jaco® Fittings	119
Brass Fittings - Lead Free	121
Hypro - Nipples, Reducing Bushings and Hosebarb Fittings.....	122
SMC® Ball Valves	123
Aquamor USA Capillaries.....	124
GWV Capillaries	124
Hydronic Engineering® Flow Restrictors	124
Reverse Osmosis Automatic Shut Off Valves (ASO)	125
Hydronic Engineering® Check Valves	125
John Guest® Check Valves	126
SMC® Check Valves	126
Jaco® Check Valves	126
Pentair® Filter Housing Wrenches, O-Rings and Brackets	127
Brackets	127
Clips	128

R.O. TANKS & ACCESSORIES













Metal Reverse Osmosis Tanks	132
Plastic Reverse Osmosis Tanks	132
Reverse Osmosis Tanks Size Chart.....	133
Amtrol™ Reverse Osmosis Tanks.....	134
Structural™ R0mate™ Tanks.....	135

FAUCETS & ACCESSORIES

Tank Pressure Gauges	135
QMP® Faucets	138
Tomlinson® Faucets	138
Good Water Warehouse Faucets	140
EMD Faucets	141









INSTALLATION SUPPLIES

Feed Valves.....		144
Drain Connectors.....		144
Vista Water Group AirGaps and Check Valves		145
Airgap Devices.....		146
Falcon® Stainless Steel Water Flex Connectors.....		147
Installation Supplies Miscellaneous.....		148
Relton® Sink Hole Cutters		148
Blue-White® Flowmeters.....		149
Apex® Pressure Limiting Valves.....		151
Leak Detectors		152
Noshok® Gauges.....		153
Solenoid Valves.....		154

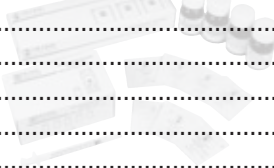
PUMPS & MOTORS

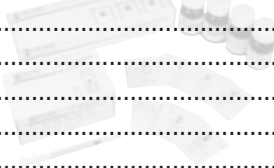
Aquatec® Booster & Delivery Pumps		158
SHURflo® Booster & Delivery Pumps		160
Flojet® Booster & Delivery Pumps		161
Procon® Commercial Pumps - Brass & Stainless Steel.....		162
48YZ Clamp On Motors		164

TESTING & MONITORING EQUIPMENT

Extech® Testing & Monitoring Equipment		166
Myron L® Testing & Monitoring Equipment		167
HM Digital Meters.....		168
Good Water Warehouse Test Strips.....		169
Clack® DI Lights.....		169
Sennotech® Quality Monitors		170
Savant® Gallonage Meters		170
Hach® Testing & Monitoring Equipment.....		170

WATER CHILLERS, COOLERS & HEATERS

EverCold® Water Chillers & Instant Hot Water System.....		172
--	--	-----

DISINFECTION SYSTEMS & COMPONENTS

VIQUA - Arros™ UV Systems		176
VIQUA - Sterilight® UV Lights.....		177
UVMax™ UV Systems		178
UV Dynamics		179
Microfilter® Ultra Violet Lights		180
Stenner Chemical Feeder Systems		180
Mazzei® Injector Company - Injectors		182



GOOD WATER WAREHOUSE LOCATIONS

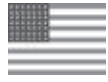

Fullerton CA, U.S.A

1700 E Walnut Ave
Fullerton, CA 92831
Tel: (714) 441-2893
Toll Free Tel: (800) 749-0252
Toll Free Fax: (800) 749-0331



Alberta, Canada

6, 3967 – 112th Avenue SE
Calgary, AB T2C 0J4
Tel: (403) 252-7972
Toll Free Tel: (888) 668-1234
Toll Free Fax: (888) 227-3291



Santa Barbara CA, U.S.A

817 Garden St Ste.100
Santa Barbara, CA 93101
Tel: (805) 683-8889
Fax: (805) 683-0102

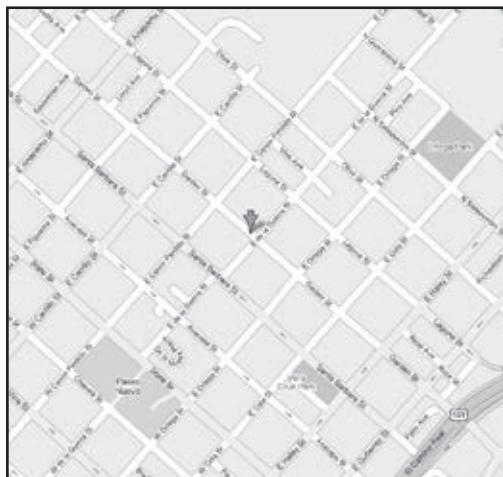

Ontario, Canada

2-1175 Kerrisdale Blvd.
Newmarket, ON. L3Y 8W1
Tel: (905) 868-9287
Toll Free Tel: (888) 868-9287
Fax: (905) 830-0512





LINE CARD (PARTIAL LIST)

Good Water Warehouse, Inc. is a stocking, master distributor for over 150 manufacturers of the highest quality residential, commercial, and industrial water filtration components and equipment. We offer factory direct pricing, worldwide distribution, short lead-times, and a knowledgeable and experienced customer service team. Please note that this is a partial list of the manufacturers that we represent. We add new manufacturers and product lines weekly. Please contact one of our customer service representatives if you do not see the manufacturer or products you require.

MANUFACTURER		PRODUCT DESCRIPTION
	AirGap International	R/O and Water Softener Air Gaps
	Amtrol™ Inc.	R/O Pressure Tanks
	Apex®	Pressure Regulators
	Aquamor	Membrane Housings, Flow Restrictors, Shutoff Valves, Clips and Drain Connectors
	AquaLock™	Large Diameter /High Pressure/Temp Quick Connect Fittings
	Aquatec Water Systems Inc.®	Delivery, Booster, Permeate R/O Pumps and Electronic Solenoids
	Blue-White Industries®	Flow Meters and Injector Pumps
	CSM®	Residential/Commercial Membranes
	EMD Global LLC	Specialty Faucets and Accessories
	Extech Instruments®	Water Testing Equipment
	Falcon Stainless (Rectorseal)	Stainless Steel Water Flex Connectors
	Filtrex Technologies	ECOCARB™ greenblock® Environmentally Friendly Filters
	Filmtec™	Commercial and Residential Membranes
	Flojet®	Booster and Delivery Pumps
	H2O International®	Shower Filters, Counter Top Filter Systems
	Harmsco Inc.®	Commercial and Residential Pleated Filters and Housings
	Hydranautics®	Membranes Commercial Membrane Elements
	Hydronamic Engineering®	Shutoff Valves, Check Valves and Flow Restrictors
	Hypro-Precision®	Plastic and Metal Fittings, Ball Valves and Pressure Gauges
	Jaco Manufacturing®	Compression Tube Fittings
	John Guest® an RWC Brand	Quick Connect Tube Fittings, Shutoff Valves and Food Grade Tubing
	KDF Fluid Treatment Inc.®	KDF® Media



Good Water Warehouse, Inc.

CANADASALES@GOODWATERWAREHOUSE.COM
GOODWATERWAREHOUSE.COM

PRICES ARE USD FOB
CALGARY/NEWMARKET

ALBERTA

TEL: (403) 252-7972
TEL: (888) 668-1234
FAX: (888) 227-3291

ONTARIO

TEL: (905) 868-9287
TEL: (888) 868-9287
FAX: (905) 830-0512



KX Technologies®

Matrikx® Carbon Block Filters



Myron L Company®

Water Testing Equipment



Noshok®

Dry and Liquid Filled Gauges



Omnipure®

Inline Cartridges, Carbon Blocks, Everpure and Cuno Style Replacement Filters



Pentair Water®



Autotrol®

Residential/Commercial/Industrial Filters, Residential Membranes and Equipment; Softener/Backwash Control Valves



CodeLine™

Fiberglass Membrane Pressure Vessels



PENTEK®

Carbon Filters, Replacement Filters and Housings



Structural®

Commercial and Residential Mineral Tanks and Accessories



Fleck®

Softener/Backwash Control Valves



Park International/Structural™

Commercial and Residential Mineral Tanks and Accessories



Shurflo Pump/Pentair®

Delivery and R/O Booster Pumps, Solenoid Switches



Procon Products®

Commercial/Light Industrial Pumps and Motors



Qmp Inc.®

R/O Faucets, Chrome Spouts and Adapters, Diverter Valves and Filter Housings



ResinTech® Inc

Specialty Filters, Filter Media and Resin



Specialty Manufacturing Co.®

PVC, Brass, SS, Ball and Check Valves



Sprite Industries Inc.®

Shower Filters



Stenner Pumps®

Chemical Injection Pumps



Tomlinson Industries®

Designer Faucets



Unicel®

Commercial and Residential Pleated Filters



United Filters

Residential and Commercial Filters

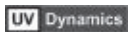

UV Dynamics

Ultraviolet Disinfection Systems



VEOLIA

Desal® from VEOLIA

Residential/Commercial/Industrial Filters, Membranes and Equipment
Commercial and Residential Membranes



Trojan Technologies™

VIQUA Arros™

UVMax™

Residential, Commercial and Industrial UV Equipment





CREDIT APPLICATION

Corporate Office
1700 E. Walnut Ave.
Fullerton, CA 92831
Toll Free Tel: (800) 749-0252
Tel: (714) 441-2893
Toll Free Fax: (800) 749-0331
sales@goodwaterwarehouse.com

Santa Barbara Office
817 Garden St ste 100
Santa Barbara, CA 93101
Tel: (805) 683-8889
Fax: (805) 683-0102
rmason@goodwaterwarehouse.com

Canadian Office - Alberta
6, 3967 - 112th Avenue SE
Calgary, AB T2C 0J4
Toll Free Tel: (888) 668-1234
Tel:(403) 252-7972
Fax:(403) 252-3462
canadasales@goodwaterwarehouse.com

Canadian Office - Ontario
2-1175 Kerrisdale Blvd.
Newmarket, ON. L3Y 8W1
Toll Free Tel: (888) 868-9287
Tel: (905) 868-9287
Fax: (905) 830-0512
canadasales@goodwaterwarehouse.com

The Information provided is for the sole purpose of obtaining credit and/or account qualifications for **Good Water Warehouse, Inc.**

Company Name: _____

Contact Person: _____

Billing Address: _____ Shipping Address: _____

City: _____ City: _____

County: _____ State/Province: _____ Zip: _____ County: _____ State/Province: _____ Zip: _____

Phone: (____) _____ Fax: (____) _____

E-Mail: _____ Cell: (____) _____

Engaged in Business Selling: _____

Type Business: [] Sole Owner [] Partnership [] Corporation [] LLC Date Est: ____/____/____

California Resale Number (If applicable): _____

Business Bank Branch _____ Account # _____

Contact Person: _____ Phone: (____) _____

Address: _____ Fax: (____) _____

City: _____ State/Province: _____ Zip: _____

TRADE REFERENCES:

Name: _____ Phone: (____) _____ Fax: (____) _____

Address: _____ City: _____ State/Province: _____ Zip: _____

Name: _____ Phone: (____) _____ Fax: (____) _____

Address: _____ City: _____ State/Province: _____ Zip: _____

Name: _____ Phone: (____) _____ Fax: (____) _____

Address: _____ City: _____ State/Province: _____ Zip: _____

Authorized Signature: _____ Date: ____/____/____

In consideration of extending credit at my request, I (the undersigned) hereby personally guarantee **Good Water Warehouse, Inc.** payment of any obligation of *Company Name* and I hereby agree to bind myself for payment of any unpaid debt including finance charges, shipping & handling and collection costs and/or attorney fees whenever the above applicant shall default on same. It is understood that this guarantee shall be continuing and irrevocable for indebtedness of *Company Name*. I also acknowledge receipt of and agree to all "terms and conditions" of **Good Water Warehouse, Inc.** (page 10)

Authorized Signature: _____ Date: ____/____/____

Print Name: _____ Title: _____ SSN: _____

CREDIT CARD AUTHORIZATION (OPTIONAL): I hereby authorize **Good Water Warehouse, Inc.** to charge the following credit card(s) for any amount that is above our credit limit and/or for any invoice that is past due.

VISA/Master/Am-Ex/Discover #: _____ - _____ - _____ - _____ Exp. Date: ____/____/____ CVC: _____

Print name: _____

Signature: _____ Date: ____/____/____



TERMS AND CONDITIONS OF SALE

GOOD WATER WAREHOUSE, INC.

ORDERING: Orders may be placed by phone, fax, and/or e-mail to **Good Water Warehouse, Inc.** Authorized purchases must include customer PO number, manufacturer's/GWW's part number, and pricing. Purchase orders received without part numbers will not be processed until the customer is contacted and part numbers are verified. Purchase orders must state if partial shipments are allowed and must designate required shipping method. If you do not have the parts numbers, pricing, or case quantity, please contact our sales department or visit our web site (www.goodwaterwarehouse.com).

ORDER CONFIRMATIONS: All purchase orders will be confirmed by phone, fax, or e-mail. Any discrepancies in pricing, part numbers, descriptions, and/or case quantities will be noted in the order confirmation. It is the customer's responsibility to review the order confirmations and advise if any changes are required. If we do not hear from the customer regarding the confirmation, we will process order according to the confirmation.

MINIMUM ORDERS: Minimum order accepted is \$100.00 net, exclusive of freight. Any orders placed that are less than \$100.00 will be assessed a \$10.00 service charge.

TERMS: Terms given on approved credit. Past due accounts will be charged interest at 1 1/2% per month. Credit will not be extended to accounts with poor payment history. Without approved credit, orders are shipped on a prepaid basis within the USA, and Irrevocable Letter of Credit or prepaid outside of the USA. Large orders and/or special item orders may also be subject to a down payment.

NSF CHECKS: There is a \$25.00 charge for all NSF checks.

INVOICING: All shipments are invoiced the day of shipping. Customers are required to pay all invoices in full within terms. Short payments on invoices are not acceptable. All questions regarding invoices and payments must be addressed with our accounts receivable department before invoices become due.

WILL CALL ORDERS: All standard ordering terms apply to WILL CALL orders. The customer must advise what day and time they will pick up the order. Completed WILL CALL order will be held for a maximum of 3 business days. A restock charge may be assessed to any WILL CALL orders that are not picked up within the required time frame. Additions or deletions to WILL CALL orders after invoicing are subject to all new order Terms and Conditions. Orders are typically pulled within one working day. WILL CALL orders can be picked up Monday – Friday from 9:00 AM – 11:30 AM and from 1:30 PM – 3:00 PM. Expediting fees may apply to same day pick ups and walk in orders. All customers are required to have a copy of their order or an order number when picking up.

TAXES: Taxes are not included. Quoted prices are exclusive of all taxes. Purchaser shall be responsible for payment of all applicable state/local sales, use and/or gross receipts' taxes resulting from transactions with **Good Water Warehouse, Inc.**, regardless of placement of liability for the tax by law. Orders shipped within California, or to Canada are subject to applicable county tax rates unless a completed resellers' card or exempt certificate is on file.

FREIGHT: All shipments are F.O.B., **Good Water Warehouse, Inc.**, Fullerton, Ca. All drop ship order will be assessed a \$10.00 handling charge.

ROUTING: To be specified by customer on purchase order, otherwise, Good Water Warehouse will ship best method.

ORDER CHANGES: Additions to an order may be made at no charge prior to the processing of an order. Processing of an order typically begins within one hour of receipt of purchase order and is typically accomplished within one working day. Deletion and/or changes to an order after it has been processed are subject to a \$25.00 minimum handling fee. Changes may cause additional charges and may increase the time required to ship an order.

RETURNS: A Return Goods Authorization (RGA) number must be obtained from **Good Water Warehouse, Inc.** within 45 days of the invoice date before any returns can be shipped. All returns for warranty consideration must be shipped prepaid. Freight collect returns will not be accepted. Returns determined to be in warranty will be replaced or repaired, and will be returned to the purchaser prepaid by surface freight.

FREIGHT CLAIMS: Shipments are the purchaser's responsibility. All shipments must be inspected for damages and counted for shortages at the time of delivery. Freight claims must be made immediately and directly to the freight carrier. **Good Water Warehouse, Inc.** will not be held responsible for breakage or shortage after products are accepted from common carrier. Any damage or discrepancy must be noted immediately and reported to GWW within 72 hours of receipt of merchandise or claim will not be accepted.

RESTOCK: Minimum restocking charge is 20% or \$50.00, whichever is higher. Orders shipped incorrectly are not subject to restock charge and correct items will be shipped prepaid by surface freight. All other returns are subject to the restock charge. Goods must be in original container and in saleable condition to be considered for restocking.

CANCELED ORDERS: Orders placed but canceled AFTER the order has been processed and sent to shipping or engineering, will be subject to a minimum 10% cancellation fee (\$50.00 minimum), assuming manufacturing has not commenced, and no detailed engineering or special parts have been ordered. Additional fees may be charged depending upon the level of completion of detailed engineering and/or if any special parts have been ordered.

THERE ARE NO EXCEPTIONS--THANK YOU FOR YOUR BUSINESS



WATER SOFTENERS, POE EQUIPMENT & COMPONENTS





WATER SOFTENER EQUIPMENT SIZING CHART

Softeners / POE

Tank Dim. (Inches)	Tank Diameter Sq. Ft. of bed area	Tank Volume Full Cu. Ft.	Tank Volume 50% Free Board Cu. Ft.	Resin Bed Depth Inches	Free Board Depth Inches	Backwash Sq. Ft. Bed Area		Kilo Grains Exchange Resin at 30,000 Gr. Per Cu. Ft.	NaCl Req. Per Regen. at 15 Per Cu. Ft.	Kilo Grains Exchange Resin at 24,000 Gr. Per Cu. Ft.	NaCl Req. Per Regen. at 8.5 Per Cu. Ft.	Kilo Grains Exchange Resin at 20,000 Gr. Per Cu. Ft.	NaCl Req. Per Regen. at 6 Per Cu. Ft.
						at 4.5 GPM	at 5.0 GPM						
6 x 13	0.20	0.2	0.13	8.7	4.3	.9	1.0	4.0	2.0	3.10	1.1	2.6	0.8
6 x 18	0.20	0.3	0.20	12.0	6.0	.9	1.0	6.0	3.0	4.80	1.7	4.0	1.2
6 x 35	0.20	0.6	0.40	23.3	11.7	.9	1.0	12.0	6.0	9.60	3.4	8.0	2.4
7 x 24	0.27	0.5	0.33	16.0	8.0	1.2	1.35	10.0	5.0	7.90	2.8	6.6	2.0
7 x 30	0.27	0.6	0.40	20.0	10.0	1.2	1.35	12.0	6.0	9.60	3.4	8.0	2.4
7 x 35	0.27	0.8	0.53	23.3	11.7	1.2	1.35	16.0	8.0	12.70	4.5	10.6	3.2
7 x 40	0.27	0.9	0.60	26.7	13.3	1.2	1.35	18.0	9.0	14.40	5.1	12.0	3.6
7 x 44	0.27	1.0	0.66	29.3	14.7	1.2	1.35	20.0	10.0	15.80	5.6	13.2	4.0
8 x 17	0.35	0.4	0.26	11.3	5.7	1.6	1.75	8.0	4.0	6.24	2.2	5.2	1.6
8 x 24	0.35	0.6	0.40	16.0	8.0	1.6	1.75	12.0	6.0	9.60	3.4	8.0	2.4
8 x 30	0.35	0.8	0.53	20.0	10.0	1.6	1.75	16.0	8.0	12.70	4.5	10.6	3.2
8 x 35	0.35	0.9	0.60	23.3	11.7	1.6	1.75	18.0	9.0	14.40	5.1	12.0	3.6
8 x 40	0.35	1.1	0.73	26.7	13.3	1.6	1.75	22.0	11.0	17.50	6.2	14.6	4.4
8 x 44	0.35	1.2	0.80	29.3	14.7	1.6	1.75	24.0	12.0	19.20	6.8	16.0	4.8
9 x 35	0.44	1.2	0.80	23.3	11.7	2.0	2.2	24.0	12.0	19.20	6.8	16.0	4.8
9 x 40	0.44	1.4	0.93	26.7	13.3	2.0	2.2	28.0	14.0	22.30	7.9	18.6	5.6
9 x 48	0.44	1.7	1.13	32.0	16.0	2.0	2.2	34.0	17.0	27.10	9.6	22.6	6.8
10 x 19	0.54	0.7	0.46	12.7	6.3	2.43	2.7	14.0	7.0	11.00	3.9	9.2	2.8
10 x 30	0.54	1.2	0.80	20.0	10.0	2.43	2.7	24.0	12.0	19.2	6.8	16.0	4.8
10 x 35	0.54	1.4	0.93	23.3	11.7	2.43	2.7	28.0	14.0	22.30	7.9	18.6	5.6
10 x 40	0.54	1.6	1.07	26.7	13.3	2.43	2.7	32.0	16.0	25.70	9.1	21.4	6.4
10 x 42	0.54	1.7	1.13	28.0	14.0	2.43	2.7	34.0	17.0	27.10	9.6	22.6	6.8
10 x 44	0.54	1.8	1.20	29.3	14.7	2.43	2.7	36.0	18.0	28.80	10.2	24.0	7.2
10 x 47	0.54	1.9	1.26	31.3	15.7	2.43	2.7	38.0	19.0	30.20	10.7	25.2	7.6
10 x 54	0.54	2.2	1.46	36.0	18.0	2.43	2.7	44.0	22.0	35.00	12.4	29.2	8.8
12 x 48	0.78	3.1	2.06	32.0	16.0	3.51	3.9	62.0	31.0	49.40	17.5	41.2	12.4
13 x 54	0.92	3.7	2.46	36.0	18.0	4.14	4.6	74.0	37.0	59.00	20.9	49.2	14.8
14 x 65	1.07	5.3	3.53	43.3	21.7	4.82	5.35	106.0	53.0	84.70	30.0	70.6	21.2
16 x 65	1.40	6.4	4.26	43.3	21.7	6.30	7.0	128.0	64.0	102.20	36.2	85.2	25.6
18 x 65	1.76	8.5	5.50	43.3	21.7	7.9	8.8	150.0	75.0	120.0	42.5	100.0	30.0
21 x 62	2.40	11.0	7.33	41.3	20.7	10.80	12.00	220.0	111.0	175.90	62.3	146.6	44.0
24 x 71	3.14	16.0	10.60	47.3	23.7	14.13	15.70	318.0	159.0	254.40	91.1	212.0	63.6
30 x 72	4.90	26.0	17.30	48.0	24.0	22.05	24.50	519.0	259.5	415.20	147.1	346.0	103.8
36 x 72	7.07	36.1	24.10	48.0	24.0	31.82	35.35	723.0	361.5	578.40	204.9	482.0	144.6
42 x 72	9.62	42.1	28.00	48.0	24.0	42.29	48.10	840.0	420.0	672.00	238	560.0	168.0

CALL GOOD WATER WAREHOUSE FOR CUSTOMIZED COMMERCIAL & INDUSTRIAL EQUIPMENT QUOTES

TECH TIPS - MEDIA BACKWASH & SERVICE RATES

MEDIA	BACKWASH RATE/FT ²	SERVICE FLOW RATE/FT ²	WEIGHT FT ³
ACTIVATED CARBON	10 - 12 GPM	5 GPM	25 LBS
BIRM REG	10 - 12 GPM	3.5 - 5 GPM	48 LBS
CATION RESIN	3 - 5 GPM	1 - 5 GPM / Cu. Ft.	54 LBS
FILTER AG	8 - 10 GPM	5 GPM	25 LBS
GREENSAND	10 - 12 GPM	3 - 5 GPM	86 LBS
KDF	30 GPM	15 GPM	171 LBS
MTM	8 - 10 GPM	2 - 5 GPM	45 - 50 LBS
MULTIMEDIA	12 -15 GPM	5 GPM	100 LBS
NEXSAND	13 - 22 GPM	12 - 20 GPM	55 LBS
PYROLUX	25 - 30 GPM	5 GPM	125 LBS



VALUMAX™ FLECK™ WATER SOFTENERS



5600 WATER SOFTENERS

- Durable time proven valve design using fiber reinforced polymer construction
- Available electromechanical and SXT electronic controls
- Down flow regeneration
- Continuous flow rate up to 20 gpm (valve only)
- Composite media tank
- 1" high flow basket riser
- 8% crosslink resin
- Heavy duty blow molded brine tank
- Brine safety valve with air check
- 5 year warranty on control, 10 year on resin tank



Softeners / POE

5600C



- 12 day clock operation
- Adjustable brine setting

Valumax 5600C - Clock Control (Not for sale in California)

Part #	Description	1±	3±	6±
CVM-.75-5600CC	0.75CUFT; 22K; 5600CC; RT8X44; BT14X34	\$415.67	\$383.69	\$364.51
CVM-1.0-5600CC	1.0CUFT; 30K; 5600CC; RT9X48; BT14X34	\$439.92	\$406.08	\$385.78
CVM-1.5-5600CC	1.5CUFT; 45K; 5600CC; RT10X54; BT14X34	\$463.58	\$427.92	\$406.53
CVM-2.0-5600CC	2.0CUFT; 60K; 5600CC; RT12X52; BT14X34	\$524.16	\$483.84	\$459.65
CVM-2.5-5600CC	2.5CUFT; 75K; 5600CC; RT13X54; BT18x40	\$574.86	\$530.64	\$504.11
CVM-3.0-5600CC	3.0CUFT; 90K; 5600CC; RT14X65; BT18X40	\$734.30	\$677.81	\$643.92

5600MI



- 0-2100 gallon meter
- Paddlewheel meter
- Adjustable brine setting

Valumax 5600MI - Mechanical Metered Control

Part #	Description	1±	3±	6±
CVM-.75-5600MI	0.75CUFT; 22K; 5600MI; RT8X44; BT14X34	\$346.01	\$319.40	\$303.43
CVM-1.0-5600MI	1.0CUFT; 30K; 5600MI; RT9X48; BT14X34	\$370.27	\$341.79	\$324.70
CVM-1.5-5600MI	1.5CUFT; 45K; 5600MI; RT10X54; BT14X34	\$393.94	\$363.63	\$345.45
CVM-2.0-5600MI	2.0CUFT; 60K; 5600MI; RT12X52; BT14X34	\$454.50	\$419.54	\$398.57
CVM-2.5-5600MI	2.5CUFT; 75K; 5600MI; RT13X54; BT18x40	\$505.20	\$466.34	\$443.03
CVM-3.0-5600MI	3.0CUFT; 90K; 5600MI; RT14X65; BT18X40	\$676.28	\$624.26	\$593.05

5600SXT



- Turbine meter
- Fully adjustable cycle times
- Backlit LCD display
- Super capacitor 12 hour clock backup

Valumax 5600SXT - Electronic Metered Control

Part #	Description	1±	3±	6±
CVM-.75-5600SXT	0.75CUFT; 22K; 5600SXT; RT8X44; BT14X34	\$428.26	\$395.32	\$375.56
CVM-1.0-5600SXT	1.0CUFT; 30K; 5600SXT; RT9X48; BT14X34	\$452.52	\$417.71	\$396.83
CVM-1.5-5600SXT	1.5CUFT; 45K; 5600SXT; RT10X54; BT14X34	\$476.19	\$439.56	\$417.58
CVM-2.0-5600SXT	2.0CUFT; 60K; 5600SXT; RT12X52; BT14X34	\$536.76	\$495.47	\$470.69
CVM-2.5-5600SXT	2.5CUFT; 75K; 5600SXT; RT13X54; BT18x40	\$587.46	\$542.27	\$515.15
CVM-3.0-5600SXT	3.0CUFT; 90K; 5600SXT; RT14X65; BT18X40	\$758.48	\$700.14	\$665.13

Install parts (bypass valves, tube adapter kits, drain fittings) are sold separately and are listed on page 19.

Units up to 2 cubic feet (12" x 52" media tank) are shipped with media loaded. Larger systems have media packaged separately which must be loaded on site.



Softeners / POE

5800 WATER SOFTENERS

- Fiber reinforced polymer valve body construction
- Cartridge based seal and spacer design
- Soft water brine refill
- 10,000 rpm 12v DC drive
- Optical sensor technology for precise piston control
- Available SXT and XTR2 electronic controls
- Programmable relay output. 1 on SXT control and 2 on XTR2 control.
- Variable reserve
- Optical sensor technology for precise piston control
- Down flow regeneration
- Continuous flow rate up to 21 gpm (valve only)
- Composite media tank
- 1" high flow basket riser
- 8% crosslink resin
- Heavy duty blow molded brine tank
- Brine safety valve with air check
- 5 year warranty on control, 10 year warranty on resin tank



5800SXT



- Service flow up to 21 GPM
- 3/4" turbine meter
- For 3/4" or 1" plumbing connections

Valumax 5800SXT - Electronic Metered Control

Part #	Description	1±	3±	6±
CVM-.75-5800SXT	.75CUFT; 24K; RT8X44; BT14X34	\$421.87	\$389.42	\$369.95
CVM-1.0-5800SXT	1.0CUFT; 30K; RT9X48; BT14X34	\$446.13	\$411.81	\$391.22
CVM-1.5-5800SXT	1.5CUFT; 45K; RT10X54; BT14X34	\$469.79	\$433.65	\$411.97
CVM-2.0-5800SXT	2.0CUFT; 60K; RT12X52; BT14X34	\$529.50	\$488.77	\$464.33
CVM-2.5-5800SXT	2.5CUFT; 75K; RT13X54; BT18x40	\$580.20	\$535.57	\$508.79
CVM-3.0-5800SXT	3.0CUFT; 90K; RT14X65; BT18X40	\$751.30	\$693.51	\$658.83

XTR2



- Color LCD touchscreen display
- Intuitive programming interface
- Advanced diagnostic
- Assistance screen with dealer info
- Field programmable via USB
- Downloadable diagnostics via USB
- Programmable relay
- Error alarm

Valumax 5800XTR2 - Electronic Touch Screen Metered Control

Part #	Description	1±	3±	6±
CVM-.75-5800XTR2	.75CUFT; 24K; RT8X44; BT14X34	\$538.16	\$496.76	\$471.93
CVM-1.0-5800XTR2	1.0CUFT; 30K; RT9X48; BT14X34	\$562.42	\$519.15	\$493.20
CVM-1.5-5800XTR2	1.5CUFT; 45K; RT10X54; BT14X34	\$586.08	\$541.00	\$513.95
CVM-2.0-5800XTR2	2.0CUFT; 60K; RT12X52; BT14X34	\$645.79	\$596.12	\$566.31
CVM-2.5-5800XTR2	2.5CUFT; 75K; RT13X54; BT18x40	\$696.49	\$642.92	\$610.77
CVM-3.0-5800XTR2	3.0CUFT; 90K; RT14X65; BT18X40	\$867.72	\$800.97	\$760.93

The new Pentair® Fleck® 5800 XTR2 Enhanced with AccuSense™ Technology:

- Thrives in areas where water hardness fluctuates.
- Processes real-time water hardness data through the XTR2 sensor control.
- Initiates regeneration only when the resin bed is exhausted (less reserve capacity).

Valumax 5800XTR2 - Enhanced with Accusense™ Technology

Part #	Description	1±	3±	6±
CVM-1.0-5800XTR2-SENSOR	1.0CUFT; 30K; RT9X48; BT14X34	\$710.69	\$656.02	\$623.22
CVM-1.5-5800XTR2-SENSOR	1.5CUFT; 45K; RT10X54; BT14X34	\$743.92	\$686.69	\$652.36
CVM-2.0-5800XTR2-SENSOR	2.0CUFT; 60K; RT12X48; BT14X34	\$792.67	\$731.69	\$695.11

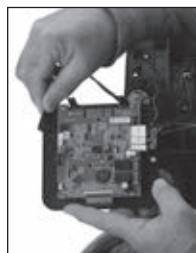



2510 WATER SOFTENERS

- Fiber reinforced polymer valve body construction
- Time-tested, hydraulically balanced piston for service and regeneration
- Rugged commercial grade drive assembly
- Fully adjustable 5 cycle control
- Backlit LCD display
- Down flow regeneration
- Continuous flow rate up to 19 gpm (valve only)
- Composite media tank
- 1" high flow basket riser
- 8% crosslink resin
- Heavy duty blow molded brine tank
- Brine safety valve with air check
- 5 year warranty on control, 10 year warranty on resin tank

SXT Control



- Backlit LCD display
- Fully adjustable cycle times
- Electronic immediate regeneration
- Diagnostics



Softeners / POE

Valumax 2510SXT - Electronic Metered Control

Part #	Description	1+	3+	6+
CVM-1.0-2510SXT	1.0CUFT; 30K; 2510SXT; RT9X48 ;BT14X34	\$647.31	\$597.52	\$567.65
CVM-1.5-2510SXT	1.5CUFT; 45K; 2510SXT; RT10X54 ;BT14X34	\$670.98	\$619.37	\$588.40
CVM-2.0-2510SXT	2.0CUFT; 60K; 2510SXT; RT12X52 ;BT18x40	\$753.78	\$695.80	\$661.01
CVM-2.5-2510SXT	2.5CUFT; 75K; 2510SXT; RT13X54; BT18x40	\$782.27	\$722.09	\$685.99
CVM-3.0-2510SXT	3.0CUFT; 90K; 2510SXT; RT14X65 ;BT18X40	\$953.35	\$880.01	\$836.01
CVM-4.0-2510SXT	4.0CUFT; 120K; 2510SXT; RT16X65 ;BT18X40	\$1,006.63	\$929.20	\$882.74

Install parts (bypass valves, tube adapter kits, drain fittings) are **sold separately** and are listed on page 19.

Units up to 2 cubic feet (12" x 52" media tank) are shipped with media loaded. Larger systems have media packaged separately which must be loaded on site.

9100 TWIN ALTERNATING WATER SOFTENERS

- Fiber reinforced polymer valve body construction
- Dual piston design
- Continuous 24/7 supply of softened water
- Soft water down flow regeneration
- Backlit LCD display
- Continuous flow rate up to 18 gpm (valve only)
- Composite media tanks
- 1" high flow basket riser
- 8% crosslink resin
- Heavy duty blow molded brine tank
- Brine safety valve with air check
- 5 year warranty on control, 10 year warranty on resin tank

SXT Control



- Backlit LCD display
- Fully adjustable cycle times
- Electronic immediate regeneration
- Diagnostics



Valumax 9100SXT - Twin Alternating Electronic Metered Control

Part #	Description	1+	3+	6+
CVM-.75-9100SXT	1.0CUFT;30K; 9100SXT-3/4" TURB; RT8X44; BT14X34	\$871.32	\$804.29	\$764.08
CVM-1.0-9100SXT	1.0CUFT;30K; 9100SXT-3/4" TURB; RT9X48; BT14X34	\$919.83	\$849.07	\$806.62
CVM-1.5-9100SXT	1.5CUFT;45K; 9100SXT-3/4" TURB; RT10X54; BT18X40	\$993.13	\$916.74	\$870.90
CVM-2.0-9100SXT	2.0CUFT;60K; 9100SXT-3/4" TURB; RT12X52; BT18X40	\$1,090.61	\$1,006.72	\$956.39
CVM-2.5-9100SXT	2.5CUFT;75K; 9100SXT 3/4" TURB; RT13X54; BT18X40	\$1,156.00	\$1,067.07	\$1,013.72
CVM-3.0-9100SXT	3.0CUFT;90K; 9100SXT 3/4" TURB; RT14X65; BT18X40	\$1,493.91	\$1,379.00	\$1,310.05
CVM-4.0-9100SXT	4.0CUFT;120K; 9100SXT 3/4" TURB; RT16X65; BT24X40	\$1,705.59	\$1,574.39	\$1,495.67

Install parts (bypass valves, tube adapter kits, drain fittings) are **sold separately** and are listed on page 19.

Units up to 2 cubic feet (12" x 52" media tank) are shipped with media loaded. Larger systems have media packaged separately which must be loaded on site.



Softeners / POE

CABINET WATER SOFTENERS



SOFTFLO CABINET

- Fleck 5600SXT Valve
- Sleek and compact appliance style design
- Space saving footprint 22.5" x 12.5" x 44.5"
- Blow molded cabinet with injection molded cover
- Direct access to electronic function (SXT models) with integrated face plate

Valumax Softflo Cabinet

Part #	Description	1±	3±	6±
CVM-SFLO-1.0-56SE	1.0CUFT;30K; SOFTFLO; 5600SXT; RT10X35	\$782.16	\$667.45	\$604.88



WS CABINET

- Fleck 5600 and 5800 valves
- Sliding cover for access to salt compartment
- Flip up access window to access valve control
- 1 cubic foot size 20.56" x 13.81" x 44.62"
- 0.5 cubic foot size 20.56" x 13.81" x 27.75"

Valumax WS Series Cabinet

Part #	Description	1±	3±	6±
CVM-WSCAB-.50-5800SXT	.50CUFT; 15K; WS CAB; 5800SXT; RT10X18	\$467.64	\$431.67	\$410.09
CVM-WSCAB-1.0-5800SXT	1.0CUFT; 30K; WS CAB; 5800SXT; RT10X35	\$535.62	\$494.42	\$469.70
CVM-WSCAB-1.0-5800XTR2	1.0CUFT; 30K; WS CAB; 5800XTR2; RT10X35	\$658.58	\$607.92	\$577.53

VALUMAX™ FLECK™ BACKWASHING FILTER SYSTEMS



- Filter media selection is based on application.
- Media data sheets are available through customer service if required.
- Backwashing filters shown represent common sizes and media choices.
- Other sizes and media selections are available.



Air Injection Oxidizer Filters (AIO)

- Simplified Iron, Manganese, and Hydrogen Sulfide removal.
- Chemical free, single tank solution.
- Utilizes an air draw cycle to create a captive air pocket above the media bed to enhance oxidation and filtration.
- SXT electronic time clock control
- 4 cycle operation - Backwash, Air Draw, Fast rinse, Service
- BIRM media for Iron and Manganese removal. Refer to media data sheet for application guidelines.
- Catalytic Carbon media for Hydrogen Sulfide removal.

Air Injection Oxidizer Filters (AIO)

Part #	Description	1±	3±	6±
CFM-1.0-5800SXT-AIO-BIRM	1.0 CUFT; BIRM; 5800SXT-AIO; RT 9X48	\$407.76	\$376.40	\$357.58
CFM-1.5-5800SXT-AIO-BIRM	1.5 CUFT; BIRM; 5800SXT-AIO; RT 10X54	\$441.34	\$407.39	\$387.02
CFM-2.0-5800SXT-AIO-BIRM	2.0 CUFT; BIRM; 5800SXT-AIO; RT 12X52	\$556.09	\$513.32	\$487.65
CFM-1.0-5800SXT-AIO-MC1240	1.0 CUFT; CATALYTIC CARB 5800SXT-AIO; RT 9X48	\$436.32	\$402.75	\$382.62
CFM-1.5-5800SXT-AIO-MC1240	1.5 CUFT; CATALYTIC CARB 5800SXT-AIO; RT 10X54	\$484.18	\$446.94	\$424.59
CFM-2.0-5800SXT-AIO-MC1240	2.0 CUFT; CATALYTIC CARB 5800SXT-AIO; RT 12X52	\$613.21	\$566.04	\$537.74
CFM-1.0-5800SXT-AIO-CENTAUR	1.0 CUFT CENTAUR CARB 5800SXT-AIO; RT 9X48	\$533.30	\$492.27	\$467.66
CFM-1.5-5800SXT-AIO-CENTAUR	1.5 CUFT CENTAUR CARB 5800SXT-AIO; RT 10X54	\$629.65	\$581.21	\$552.15
CFM-2.0-5800SXT-AIO-CENTAUR	2.0 CUFT CENTAUR CARB 5800SXT-AIO; RT 12X52	\$809.52	\$747.25	\$709.89
CFM-1.0-2510AIO-BIRM	1.0 CUFT; BIRM; 2510SXT-AIO; RT 9X48	\$569.40	\$525.60	\$499.32
CFM-1.5-2510AIO-BIRM	1.5 CUFT; BIRM; 2510SXT-AIO; RT 10X54	\$602.98	\$556.60	\$528.77
CFM-2.0-2510AIO-BIRM	2.0 CUFT; BIRM; 2510SXT-AIO; RT 12X52	\$723.40	\$667.75	\$634.36
CFM-1.0-2510AIO-MC1240	1.0 CUFT; CATALYTIC CARB; 2510SXT-AIO; RT 9X48	\$597.96	\$551.96	\$524.37
CFM-1.5-2510AIO-MC1240	1.5 CUFT; CATALYTIC CARB; 2510SXT-AIO; RT 10X54	\$645.81	\$596.13	\$566.33
CFM-2.0-2510AIO-MC1240	2.0 CUFT; CATALYTIC CARB; 2510SXT-AIO; RT 12X52	\$783.46	\$723.20	\$687.04
CFM-1.0-2510AIO-CENTAUR	1.0 CUFT CENTAUR CARB 2510SXT-AIO; RT 9X48	\$703.10	\$649.01	\$616.56
CFM-1.5-2510AIO-CENTAUR	1.5 CUFT CENTAUR CARB 2510SXT-AIO; RT 10X54	\$791.29	\$730.42	\$693.90
CFM-2.0-2510AIO-CENTAUR	2.0 CUFT CENTAUR CARB 2510SXT-AIO; RT 12X52	\$974.47	\$899.51	\$854.54



5800 SXT

Carbon Filters

- Chlorine reduction
- Taste and odor reduction
- Reduction of chemical by-products of chlorination, pesticides, herbicides and other organic chemicals
- 3 cycle operation - Backwash, Fast rinse, Service
- Carbon works by chemical adsorption, and will need periodic replacement to maintain effectiveness

Carbon Filters

Part #	Description	1±	3±	6±
CFM-1.0-5800SXT-CARBON	1.0CUFT; CARBON; 5800SXT; RT 9X48	\$357.96	\$330.42	\$313.90
CFM-1.5-5800SXT-CARBON	1.5CUFT; CARBON; 5800SXT; RT10X54	\$384.86	\$355.26	\$337.50
CFM-2.0-5800SXT-CARBON	2.0CUFT; CARBON; 5800SXT; RT12X52	\$443.60	\$409.47	\$389.00
CFM-3.0-5800SXT-CARBON	3.0CUFT; CARBON; 5800SXT; RT14X65	\$696.91	\$643.30	\$611.14
CFM-1.0-2510-CARBON	1.0CUFT; CARBON; 2510FC; 120V; RT 9X48	\$454.12	\$419.19	\$398.23
CFM-1.5-2510-CARBON	1.5CUFT; CARBON; 2510FC; 120V; RT10X54	\$480.26	\$443.32	\$421.16
CFM-2.0-2510-CARBON	2.0CUFT; CARBON; 2510FC; 120V; RT12X52	\$539.76	\$498.24	\$473.33
CFM-3.0-2510-CARBON	3.0CUFT; CARBON; 2510FC; 120V; RT14X65	\$791.01	\$730.16	\$693.66
CFM-1.0-2510SXT-CARBON	1.0CUFT; CARBON; 2510SXT; RT 9X48	\$477.14	\$440.43	\$418.41
CFM-1.5-2510SXT-CARBON	1.5CUFT; CARBON; 2510SXT; RT10X54	\$504.03	\$465.26	\$442.00
CFM-2.0-2510SXT-CARBON	2.0CUFT; CARBON; 2510SXT; RT12X52	\$562.77	\$519.48	\$493.51
CFM-3.0-2510SXT-CARBON	3.0CUFT; CARBON; 2510SXT; RT14X65	\$814.03	\$751.41	\$713.84



2510 SXT

Catalytic Carbon Filters

- Chloramine reduction
- Iron and Hydrogen Sulfide removal (typically requires air injection)
- 3 cycle operation - Backwash, Fast rinse, Service

Catalytic Carbon Filters

Part #	Description	1±	3±	6±
CFM-1.0-5800SXT-MC1240	1.0CUFT; CATALYTIC CARBON; 5800SXT; RT9X48	\$457.87	\$422.65	\$401.52
CFM-1.5-5800SXT-MC1240	1.5CUFT; CATALYTIC CARBON; 5800SXT; RT10x54	\$503.29	\$464.58	\$441.35
CFM-2.0-5800SXT-MC1240	2.0CUFT; CATALYTIC CARBON; 5800SXT; RT12X52	\$527.42	\$486.85	\$462.51
CFM-3.0-5800SXT-MC1240	3.0CUFT; CATALYTIC CARBON; 5800SXT; RT14X65	\$822.11	\$758.87	\$720.92
CFM-1.0-2510SXT-MC1240	1.0CUFT; CATALYTIC CARBON; 2510SXT; RT9X48	\$519.04	\$479.12	\$455.16
CFM-1.5-2510SXT-MC1240	1.5CUFT; CATALYTIC CARBON; 2510SXT; RT10x54	\$566.91	\$523.30	\$497.14
CFM-2.0-2510SXT-MC1240	2.0CUFT; CATALYTIC CARBON; 2510SXT; RT12X52	\$646.59	\$596.85	\$567.01
CFM-3.0-2510SXT-MC1240	3.0CUFT; CATALYTIC CARBON; 2510SXT; RT14X65	\$939.22	\$866.97	\$823.63



5800 SXT with Feeder

Greensand Plus Filters

- Removal of Iron, Manganese, Hydrogen Sulfide, Arsenic and Radium
- Effective over a broad pH range
- Batch regeneration
- Includes 10"x16" potassium permanganate feeder tank.
- 5 cycle operation - Backwash, Chem Draw, Fast rinse, Refill, Service

Greensand Filters (With KMnO4 Feeder)

Part #	Description	1±	3±	6±
CFM-1.0-5800SXT-GRNSAND	1.0CUFT; GRNSAND; 5800SXT; RT9X48	\$476.53	\$439.87	\$417.88
CFM-1.5-5800SXT-GRNSAND	1.5CUFT; GRNSAND; 5800SXT RT10X54	\$521.25	\$481.15	\$457.09
CFM-2.0-5800SXT-GRNSAND	2.0CUFT; GRNSAND; 5800SXT RT12X52	\$651.48	\$601.37	\$571.30
CFM-1.0-2510-GRNSAND	1.0CUFT; GREENSAND; 2510CC; 120V; RT9X48	\$573.48	\$529.37	\$502.90
CFM-1.5-2510-GRNSAND	1.5CUFT; GREENSAND; 2510CC; 120V; RT10X54	\$633.77	\$585.02	\$555.77
CFM-2.0-2510-GRNSAND	2.0CUFT; GREENSAND; 2510CC; 120V; RT12X52	\$769.40	\$710.21	\$674.70
CFM-1.0-2510SXT-GRNSAND	1.0CUFT; GREENSAND; 2510SXT; RT9X48	\$608.44	\$561.63	\$533.55
CFM-1.5-2510SXT-GRNSAND	1.5CUFT; GREENSAND; 2510SXT; RT10X54	\$653.15	\$602.91	\$572.76
CFM-2.0-2510SXT-GRNSAND	2.0CUFT; GREENSAND; 2510SXT; RT12X52	\$783.71	\$723.42	\$687.25



Softeners / POE



5800 SXT

Nextsand Filters

- Turbidity reduction providing filtration down to 3-5 micron
- High service flow
- Removal of precipitated material after chemical feed (chlorine, peroxide, etc)
- Durable, long lasting media (typically 5+ years)
- 3 cycle operation - Backwash, Fast rinse, Service

Nextsand Filters

Part #	Description	1±	3±	6±
CFM-1.0-5800SXT-NEXSAND	1.0CUFT; NEXSAND; 5800SXT; RT 9X48	\$328.77	\$303.48	\$288.31
CFM-1.5-5800SXT-NEXSAND	1.5CUFT; NEXSAND; 5800SXT; RT10X54	\$342.10	\$315.78	\$300.00
CFM-2.0-5800SXT-NEXSAND	2.0CUFT; NEXSAND; 5800SXT; RT12X52	\$435.68	\$402.17	\$382.06
CFM-3.0-5800SXT-NEXSAND	3.0CUFT; NEXSAND; 5800SXT; RT14X65	\$613.41	\$566.22	\$537.91
CFM-1.0-2510-NEXSAND	1.0CUFT; NEXSAND; 2510FC; RT 9X48	\$424.93	\$392.24	\$372.63
CFM-1.5-2510-NEXSAND	1.5CUFT; NEXSAND; 2510FC; RT10X54	\$438.25	\$404.54	\$384.32
CFM-2.0-2510-NEXSAND	2.0CUFT; NEXSAND; 2510FC; RT 12X52	\$531.83	\$490.92	\$466.38
CFM-3.0-2510-NEXSAND	3.0CUFT; NEXSAND; 2510FC; RT14X65	\$707.52	\$653.09	\$620.44
CFM-1.0-2510SXT-NEXSAND	1.0CUFT; NEXSAND; 2510SXT; RT 9X48	\$449.98	\$415.37	\$394.60
CFM-1.5-2510SXT-NEXT SAND	1.5CUFT; NEXSAND; 2510SXT; RT10X54	\$461.27	\$425.79	\$404.50
CFM-2.0-2510SXT-NEXSAND	2.0CUFT; NEXSAND; 2510SXT; RT 12X52	\$559.54	\$516.50	\$490.67
CFM-3.0-2510SXT-NEXSAND	3.0CUFT; NEXSAND; 2510SXT; RT14X65	\$730.53	\$674.34	\$640.62

FLECK™ VALVES



FLECK VALVES

Additional parts may need to be ordered separately to modify valves for your application.

See page 20 for other available injectors and flow control washers.

Covers, bezels, drain retainers and other parts not included with valves are listed below the valve section.



5600



5800SXT



5800XTR2

5600 Control Valve

Part #	Description	1±	4±	8±
560001-001	5600 3 CYCLE; 12D; 120V; NO DLFC	\$201.17	\$193.58	\$185.98
560001-003	5600 5 CYCLE; 12D; 120V; #1 INJ; 0.5 BLFC; NO DLFC	\$211.91	\$203.91	\$195.92
560002-001	5600 5 CYCLE; STD MTR; 120V; #1INJ, 0.5 BLFC; NO DLFC	\$293.84	\$282.75	\$271.66
560001-006	5600 "L" 5 CYCLE; 24V; 12D; #1 INJ; 0.5 BLFC; INC CVR & US TSF	\$241.29	\$232.19	\$223.08
560002-004	5600 "L" 5 CYCLE; 24V; STD MTR; #1 INJ; 0.5 BLFC; INC CVR & US TSF	\$322.66	\$310.48	\$298.31
560006-007	5600SXT 3 CYCLE; 24V; TIME CLOCK; 24V; NO DLFC	\$205.13	\$197.39	\$189.64
560006-011	5600SXT 5 CYCLE; 24V; TIME CLOCK; #1 INJ; 0.5 BLFC; NO DLFC	\$215.86	\$207.71	\$199.57
560006-003	5600SXT 5 CYCLE; 24V; TURBINE MTR; #1 INJ; 0.5 BLFC; NO DLFC	\$289.32	\$278.40	\$267.48
560006-009	5600SXT 5 CYCLE; 24V; PADDLE MTR; #1 INJ; 0.5 BLFC; NO DLFC	\$289.32	\$278.40	\$267.48

5800 Control Valve (Includes US Transformer, Cover) DLFC, DLFC Retainer, Bezel not included

Part #	Description	1±	4±	8±
580006-003	5800SXT; 3 CYCLE; TIME CLOCK	\$184.78	\$177.81	\$170.84
580006-005	5800SXT; 5 CYCLE; TIME CLOCK; #1/0.25	\$195.52	\$188.14	\$180.76
580006-001	5800SXT; 5 CYCLE; DOWNFLOW; TURB MTR; #1/0.25	\$210.21	\$202.28	\$194.34
580006-015	5800SXT; 5 CYCLE; DOWNFLOW; PDL MTR; #00/0.125	\$210.21	\$202.28	\$194.34
580006-002	5800SXT; 5 CYCLE; UPFLOW; TURB MTR; #00/0.125	\$219.61	\$211.32	\$203.03
580008-001	5800XTR2; 5 CYCLE; DOWNFLOW; TURB MTR; #00/0.125	\$318.70	\$306.67	\$294.65
60705-00	DLFC RETAINER 1/2QC X 1/2FNPT; (REQ'D ALL 5800 VALVES)	\$5.74	\$5.52	\$5.31



Softeners / POE



2510

2510 Control Valve (DLFC, Retainer & Cover Not included)

Part #	Description	1+	4+	8+
251001-001	2510 3 CYCLE; 120V; 12D; NO DLFC/CVR	\$219.65	\$211.36	\$203.08
251001-002	2510 5 CYCLE; 120V; 12D; 1650 #1/50; NO DLFC/CVR	\$290.35	\$279.39	\$268.44
251002-001	2510 5 CYCLE; 120V; STD MTR; 1650 #1/50; NO DLFC/CVR	\$374.71	\$360.57	\$346.43
251006-003	2510SXT 3 CYCLE; 24V; TIME CLOCK; NO DLFC/CVR	\$280.20	\$269.63	\$259.05
251006-001	2510SXT 5 CYCLE; 24V; TIME CLOCK; 1650/#2; NO DLFC/CVR	\$303.03	\$291.59	\$280.16
251006-005	2510SXT 5 CYCLE; 24/60; 3/4" PDL; 1650 #1/50; NO DLFC/CVR	\$381.20	\$366.82	\$352.43
251006-007	2510 AIO ;SXT;TC;24V; 4GPM DLFC; UPPER DEFLECTOR; NO CVR	\$361.80	\$348.15	\$334.50
60705-00	DLFC RETAINER 1/2 QC X 1/2 FNPT; (REQ'D ALL 2510 VALVES)	\$5.74	\$5.52	\$5.31



9100

9000 / 9100 Twin Alternating Control Valve (DLFC & Second Tank Connector not Included)

Part #	Description	1+	4+	8+
910002-001	9100 MI 3/4"STD RGE #1 INJ.50 BLFC; No DLFC or 2nd Tank Con.	\$463.36	\$445.87	\$428.39
910006-004	9100 SXT 3/4" Turbine #2 INJ.50 BLFC; No DLFC or 2nd Tank Con.	\$497.83	\$479.04	\$460.26
910006-005	9100 SXT 3/4" Paddle; #1 INJ.50 BLFC; No DLFC or 2nd Tank Con.	\$497.83	\$479.04	\$460.26
910006-007	9100 SXT 1" Paddle; #3 INJ 1.0 BLFC; No DLFC or 2nd Tank Con.	\$661.13	\$636.18	\$611.23

9000 / 9100 Second Tank Connector Assemblies

Part #	Description	1+	4+	8+
60425-9	TUBE ASSY,9100,6-9" TANK	\$33.50	\$32.24	\$30.97
60425-12	TUBE ASSY,9100,6-12" TANK	\$38.49	\$37.04	\$35.59
60425-16	TUBE ASSY,9100,13-16" TANK	\$42.01	\$40.43	\$38.84

VALUMAX™ FLECK™ INSTALL PARTS AND VALVE ACCESSORIES

5600 / 5800 / 2510 / 9000 / 9100 Bypass & Yoke



(60040SS)

Part #	Description	1+	4+	8+
60040SS	3/4" BYPASS; NPT; STAINLESS	\$51.30	\$49.37	\$47.43
60041SS	1" BYPASS; NPT; STAINLESS	\$54.14	\$52.10	\$50.06
60049	PLASTIC BYPASS VALVE (YOKE REQUIRED)	\$26.49	\$25.49	\$24.50
18706	1" MPT YOKE; PLASTIC	\$7.41	\$7.13	\$6.86
13708-40	1" SWEAT, YOKE ASSY	\$58.99	\$56.77	\$54.54
18706-02	3/4" MPT YOKE; PLASTIC	\$7.41	\$7.13	\$6.86
41027-01	YOKE,3/4",NPT,CAST,MACHD, SS	\$23.71	\$22.81	\$21.92
61700	YOKE ASSY, 3/4" CTS QC, 2510/5600/5800/9100	\$39.50	\$38.01	\$36.52
61694	YOKE ASSY, 1"CTS QC, 2510/5600/5800/9100	\$30.10	\$28.97	\$27.83
14105	BYPASS SEAL; 560CD	\$6.95	\$6.69	\$6.43



(60049)



(18706-02)



(61694)

Drain Fittings

Part #	Description	1+	10+	24+	48+
3A12G	1/2" X 1/2" HB CONNECTOR	\$0.66	\$0.58	\$0.53	\$0.51
3EL12G	1/2" X 1/2" HB ELBOW	\$1.04	\$0.90	\$0.83	\$0.79
3EL3412F	3/4" FPT X 1/2" HB ELBOW	\$2.55	\$2.21	\$2.04	\$1.94



Drin Fitting
(3EL12G)

Valve Accessories

Part #	Description	1+	4+	8+
19620-01	90 DEGREE ANGLE ADAPTER	\$8.77	\$8.44	\$8.10
60705-00	DFLC RETAINER; 1/2QCX1/2"FNPT (REQ'D ALL 5800 & 2510 VALVE)	\$5.74	\$5.52	\$5.31
18280	UPPER BASEKET; 1.05"	\$2.06	\$1.98	\$1.91
43261	COVER, BLACK, 5800/5810/5812 (REQUIRES BEZEL)	\$5.63	\$5.42	\$5.21
43262-00	BEZEL, BLUE, 5800/5810/5812	\$2.50	\$2.41	\$2.31
43262-01	BEZEL, BLACK, 5800/5810/5812	\$2.62	\$2.52	\$2.43
60226-11	DESIGNER COVER 5600 "L"/4650;BLACK	\$16.00	\$15.40	\$14.79
13753-02	COVER 5600 BLACK	\$7.70	\$7.41	\$7.12
60219-02	COVER, ENVIRO, BLACK W/CLEAR WINDOW (2510 VALVE)	\$24.86	\$23.92	\$22.99
60232-110	VALVE COVER; BLACK/BLACK; DESIGNER; (9000 & 9100 VALVE)	\$29.35	\$28.24	\$27.13



Softeners / POE

FLECK™ PARTS AND SERVICE ACCESSORIES



Injectors

INJECTORS

1600 Injectors (Require Throat and Nozzle): 1500, 2510, 2750, 2850, 2900, 5600, 9000, 9500

Part #	Description	1±	10±	24±	48±
10913-000	NOZZLE,INJECTOR,#000,BROWN (6" TANK)	\$2.61	\$2.24	\$2.13	\$2.05
10914-000	THROAT,INJECTOR,#000,BROWN (6" TANK)	\$2.61	\$2.24	\$2.13	\$2.05

Part #	Description	1±	4±	8±
10913-00	NOZZLE,INJECTOR,#00, VIOLET (7" TANK)	\$2.69	\$2.59	\$2.48
10913-0	NOZZLE,INJECTOR,#0, RED (8" TANK)	\$3.27	\$3.15	\$3.03
10913-1	NOZZLE,INJECTOR,#1,WHITE (9 & 10" TANK)	\$2.81	\$2.71	\$2.60
10913-2	NOZZLE,INJECTOR,#2, BLUE (12" TANK)	\$2.81	\$2.71	\$2.60
10913-3	NOZZLE,INJECTOR,#3, YELLOW (13" TANK)	\$2.81	\$2.71	\$2.60
10913-4	NOZZLE,INJECTOR,#4, GREEN (14" TANK)	\$3.09	\$2.97	\$2.86
10914-00	THROAT,INJECTOR,#00, VIOLET (7" TANK)	\$3.09	\$2.97	\$2.86
10914-0	THROAT,INJECTOR,#0, RED (8" TANK)	\$3.09	\$2.97	\$2.86
10914-1	THROAT,INJECTOR,#1,WHITE (9 & 10" TANK)	\$2.81	\$2.71	\$2.60
10914-2	THROAT,INJECTOR,#2, BLUE (12" TANK)	\$2.81	\$2.71	\$2.60
10914-3	THROAT,INJECTOR,#3, YELLOW (13" TANK)	\$2.81	\$2.71	\$2.60
10914-4	THROAT,INJECTOR,#4, GREEN (14" TANK)	\$3.09	\$2.97	\$2.86

1610 Injectors (One Piece): 7000/5810/5812

Part #	Description	1±	4±	8±
61454-00	INJECTOR ASSY,7000,#00 VIOLET (9 & 10" TANK)	\$10.56	\$10.16	\$9.77
61454-0	INJECTOR ASSY,7000,#0 RED (12 & 13" TANK)	\$10.56	\$10.16	\$9.77
61454-1	INJECTOR ASSY,7000,#1 WHITE (14 & 16" TANK)	\$10.56	\$10.16	\$9.77
61454-2	INJECTOR ASSY,7000,#2, BLUE(18" TANK)	\$10.56	\$10.16	\$9.77
61454-3	INJECTOR ASSY,7000,#3, YELLOW (20" TANK)	\$10.56	\$10.16	\$9.77
61454-4	INJECTOR ASSY,7000,#4, GREEN (21" TANK)	\$10.56	\$10.16	\$9.77
61454-5	INJECTOR ASSY,7000,#5, GRAY (24" TANK)	\$10.56	\$10.16	\$9.77

1610 Injectors (One Piece): 5000, 5800

Part #	Description	1±	4±	8±
18272-000	INJECTOR ASSY,1610,#000, BROWN (8" TANK)	\$12.35	\$11.88	\$11.42
18272-00	INJECTOR ASSY,1610,#00, VIOLET (9 & 10" TANK)	\$3.34	\$3.21	\$3.09
18272-0	INJECTOR ASSY,1610,#0, RED (12 & 13" TANK)	\$3.34	\$3.21	\$3.09
18272-1	INJECTOR ASSY,1610,#1, WHITE (14 & 16" TANK)	\$3.34	\$3.21	\$3.09
18272-2	INJECTOR ASSY,1610,#2, BLUE (18" TANK)	\$3.34	\$3.21	\$3.09

Part #	Description	1±	10±	24±	48±
18272-3	INJECTOR ASSY,1610,#3, BLUE (20" TANK)	\$3.09	\$2.65	\$2.52	\$2.43

1700 Injectors (Require Throat and Nozzle): 2750, 2850, 2900, 9500

Part #	Description	1±	10±	24±	48±
14802-06C	THROAT, INJECTOR, #6C, RED (30 - 36" TANK)	\$2.94	\$2.52	\$2.40	\$2.31

Flow Washers, Brine Flow Control Assemblies, Drain Flow Control Assemblies 1600 Brine Flow Washer

Part #	Description	1±	4±	8±
17307	WASHER, FLOW, .125 GPM	\$3.17	\$3.05	\$2.94
12094	WASHER, FLOW, .25 GPM	\$1.47	\$1.41	\$1.36
12095	WASHER, FLOW, .50 GPM	\$1.47	\$1.41	\$1.36
12097	WASHER, FLOW, 1.0 GPM	\$1.34	\$1.29	\$1.23

0.69" Outside Diameter

Part #	Description	1±	4±	8±
19151	WASHER, FLOW, 1.0 GPM	\$2.94	\$2.83	\$2.71
12085	WASHER, FLOW, 1.2 GPM	\$2.88	\$2.77	\$2.66
12086	WASHER, FLOW, 1.5 GPM	\$2.50	\$2.41	\$2.31
19149	WASHER, FLOW, 1.7 GPM	\$2.94	\$2.83	\$2.71
12087	WASHER, FLOW, 2.0 GPM	\$2.28	\$2.20	\$2.11
12088	WASHER, FLOW, 2.4 GPM	\$2.62	\$2.52	\$2.43
12089	WASHER, FLOW, 3.0 GPM	\$2.50	\$2.41	\$2.31
12090	WASHER, FLOW, 3.5 GPM	\$2.62	\$2.52	\$2.43
12091	WASHER, FLOW, 4.0 GPM	\$2.50	\$2.41	\$2.31
19147	WASHER, FLOW, 4.5 GPM	\$2.94	\$2.83	\$2.71
12092	WASHER, FLOW, 5.0 GPM	\$2.28	\$2.19	\$2.11
17814	WASHER, FLOW, 6.0 GPM	\$2.50	\$2.41	\$2.31
12408	WASHER, FLOW, 7.0 GPM	\$2.62	\$2.52	\$2.43



Softeners / POE

0.95" Outside Diameter

Part #	Description	1±	4±	8±
17944	WASHER,FLOW,9.0 GPM	\$3.54	\$3.41	\$3.27
16529	WASHER,FLOW,10.0 GPM	\$2.94	\$2.83	\$2.71
16736	WASHER,FLOW,15.0 GPM	\$2.94	\$2.83	\$2.71
16528	WASHER,FLOW,20.0 GPM	\$2.94	\$2.83	\$2.71
16737	WASHER,FLOW,25.0 GPM	\$2.94	\$2.83	\$2.71

1600 Complete BLFC Assemblies - Brass

Part #	Description	1±	10±	24±	48±
60022-12	BLFC ASSY, .125 GPM; 5000/5600/5800/9000/9100	\$10.07	\$8.63	\$8.20	\$7.91

Part #	Description	1±	4±	8±
60022-25	BLFC ASSY, .25 GPM; 5000/5600/5800/9000/9100	\$11.94	\$11.49	\$11.04
60022-50	BLFC ASSY, .50 GPM; 5000/5600/5800/9000/9100	\$11.94	\$11.49	\$11.04
60020-25	BLFC ASSY, .25 GPM; 2510/2750/2850/2900/9500	\$22.36	\$21.51	\$20.67
60020-50	BLFC ASSY, .50 GPM; 2510/2750/2850/2900/9500	\$20.37	\$19.60	\$18.83
60020-100	BLFC ASSY,1.0 GPM; 2510/2750/2850/2900/9500	\$20.95	\$20.16	\$19.37

1" Commercial BLFC; 3150, 3900

Part #	Description	1±	4±	8±
60710-2.0	BLFC,1"F X 1"M,NPT,2.0 GPM BRASS	\$63.35	\$60.96	\$58.57
60710-4.0	BLFC,1"F X 1"M,NPT,2.0 GPM BRASS	\$60.33	\$58.05	\$55.78
60710-5.0	BLFC,1"F X 1"M,NPT,5.0 GPM BRASS	\$60.48	\$58.20	\$55.91



(60365-00)

Brass DLFC Assemblies

Part #	Description	1±	4±	8±
60365-00	DLFC,3/4"F X 1/2"F,NPT,BRASS NO BUTTON <i>*Requires one 0.69" flow washer. (1 - 7 gpm) 2750/2900/2900s valve</i>	\$24.80	\$23.86	\$22.93
60699-00	DLFC,3/4"F X 3/4"F, BRASS NO BUTTON <i>*Requires one 0.69" flow washer. (1 - 7 gpm) 2750/2900/2900s valve</i>	\$26.53	\$25.53	\$24.52
60700-00	DLFC,3/4"F X 3/4"F,NPT,BRASS NO BUTTON <i>*Requires one 0.95" flow washer. (8 - 25 gpm) 2750/2900/2900s valve</i>	\$31.85	\$30.65	\$29.45
60366-00	DLFC,1"F X 3/4"F,NP, BRASS NO BUTTON <i>*Requires one 0.69" flow washer. (1 - 7 gpm) 2850/2900s/9000 valve</i>	\$29.92	\$28.79	\$27.66
60708-00	DLFC,1"F X 3/4"F,NPT,BRASS NO BUTTON <i>*Requires one 0.95" flow washer. (8 - 25 gpm) 2850/2900s/9000 valve</i>	\$52.04	\$50.07	\$48.11
60721-00	DLFC,1"F X 1"F,NPT, BRASS NO BUTTON <i>*Requires one 0.69" flow washer. (1 - 7 gpm) 2850/2900s/9000 valve</i>	\$53.95	\$51.92	\$49.88
60701-00	DLFC,1"F X 1"F,NPT,BRASS NO BUTTON <i>*Requires one 0.95" flow washer. (8 - 25 gpm) 2850/2900s/9000 valve</i>	\$48.83	\$46.99	\$45.15
61640-01	DLFC, PLASTIC, LESS BTTN W/1 HOLE <i>*Requires 1 - 3 0.95" flow washer (8-75 gpm) 2850s valve</i> <i>**Requires connector assy x2; See 7000 valve section</i>	\$48.15	\$46.33	\$44.52
60711-00	DLFC,2" NPT,LESS BTTNS,W/2 HOLES <i>*Requires 2 - 4 0.95" flow washers (16 - 100 gpm) 3150/3900 valve</i>	\$147.76	\$142.18	\$136.61



Valve Covers

Valve Covers

Part #	Description	1±	4±	8±
60219-02	COVER ASSY,ENVIRONMENTAL,BLACK W/CLEAR WINDOW	\$24.86	\$23.92	\$22.99
60217-02	COVER ASSY 2900,LOWER ENVIRONMENTAL,BLACK	\$28.67	\$27.59	\$26.50
60232-110	VALVE COVER, BLACK/BLACK, DESIGNER BACKPLATE	\$29.35	\$28.24	\$27.13
60226-11	DESIGNER COVER 5600L/4650,BLACK	\$16.00	\$15.40	\$14.79
13753-02	COVER 5600 BLACK	\$7.70	\$7.41	\$7.12
43261	COVER, BLACK, 5800/5810/5812 (REQUIRES BEZEL)	\$5.63	\$5.42	\$5.21
43262-00	BEZEL, BLUE, 5800/5810/5812	\$2.50	\$2.41	\$2.31
43262-01	BEZEL, BLACK, 5800/5810/5812	\$2.62	\$2.52	\$2.43



Softeners / POE



Piston Assy
(60090)



5600 Powerhead
(62091-01)



5600 Piston Assy
(60102-00)



Seal & Spacer Kit
(60125)

RESIDENTIAL VALVE PARTS AND SERVICE ASSEMBLIES 2510

Part #	Description	1±	4±	8±
60090	PISTON ASSY	\$42.10	\$40.51	\$38.93
60121	SEAL & SPACER KIT	\$17.07	\$16.43	\$15.78
60705-00	1/2QC X 1/2 FNPT; PLASTIC DLFC RETAINER; LESS BTN	\$5.74	\$5.52	\$5.31
60029	1600 SHORT STEM BRINE VALVE	\$45.69	\$43.97	\$42.24
60088-180	METER ASSY 3/4 DUAL PORT; RT ANGLE; 2510 STD RNGE	\$120.33	\$115.79	\$111.24
60050-23	DRIVE ASSY, 1500, 2510, 2750, 2850; STF; 24V 50/60HZ	\$208.50	\$200.63	\$192.77
60050-21	DRIVE ASSY, 1500, 2510, 2750, 2850; STF; 120V 60HZ	\$150.67	\$144.99	\$139.30
42778	TIMER ASSY, SXT, 2510/2750/2850/2850s	\$167.21	\$160.90	\$154.60
44144	TRANSFORMER, US, 24VAC, 40VA	\$77.34	\$74.42	\$71.50

5600 / 5600SXT

Part #	Description	1±	4±	8±
62091-01	5600 POWERHEAD; FILTER; 12 DAY 120V	\$124.80	\$120.09	\$115.38
62090-01	5600 POWERHEAD; SOFT; 12DAY; 120V	\$103.08	\$99.19	\$95.30
62089-03	5600 POWERHEAD; SOFT; STD RGE MTR; 120V	\$119.12	\$114.62	\$110.13
62090-04	5600 "L" POWERHEAD; SOFT; 12DAY; 120V	\$119.12	\$114.62	\$110.13
62089-09	5600 "L" POWERHEAD; SOFT STD RGE MTR; 120V	\$128.36	\$123.51	\$118.67
62089-10	5600 "L" POWERHEAD; SOFT STD RGE MTR; 24V; NO TSF	\$123.42	\$118.76	\$114.10

Part #	Description	1±	6±	12±	24±
62090-02	5600 "L" POWERHEAD; SOFT; 12 DAY; 24V; NO TSF	\$112.31	\$96.26	\$91.45	\$88.24
62089-08	5600 "L" POWERHEAD; SOFT EXT RGE MTR; 120V	\$110.25	\$94.50	\$89.78	\$86.63

Part #	Description	1±	4±	8±	
60102-00	PISTON ASSY, 5600; STD SOFTENER	\$33.93	\$32.65	\$31.37	
60102-101	PISTON ASSY, 5600; FILTER	\$33.86	\$32.58	\$31.30	
60102-201	PISTON ASSY, 5600; LOW WATER	\$35.99	\$34.63	\$33.28	
60102-711	PISTON ASSY, 5600SXT, DOWNFLOW	\$34.00	\$32.72	\$31.43	
60125	SEAL & SPACER KIT	\$14.98	\$14.41	\$13.85	
60084-0141	INJECTOR/DRAIN ASSY #1; 2.4 DLFC.25 BLFC *	\$59.19	\$56.96	\$54.72	
<i>* CONSULT SALES FOR ADDITIONAL CONFIGURATIONS</i>					
60032	BRINE VALVE	\$9.52	\$8.16	\$7.76	\$7.48
60514	BRINE CAM ASSY, 5600, 3-16 LBS	\$4.90	\$4.20	\$3.99	\$3.85
60514-01	BRINE CAM ASSY, 5600, 6-32 LBS	\$4.90	\$4.20	\$3.99	\$3.85
60086	METER ASSY, 5600/9000/9100 3/4" STD	\$120.05	\$102.90	\$97.75	\$94.32
60086-50	METER ASSY, 5600/9000/9100 3/4"; ELECTRONIC PDL	\$128.92	\$110.51	\$104.98	\$101.30
60626	METER ASSY, TURBINE, ELECTRONIC	\$120.25	\$103.07	\$97.92	\$94.48
19121-01	METER CABLE ASSY, PDL SXT	\$21.85	\$18.73	\$17.79	\$17.17
61672-0201	TIMER ASSY, 56SXT, FRONT SQUARE	\$182.70	\$156.60	\$148.77	\$143.55
18743	MOTOR; TIMER/DRIVE; 1/30RPM 120V; 5600 MECHANICAL	\$44.99	\$38.57	\$36.64	\$35.35
16944	MOTOR, DRIVE, 24V/60, 2 RPM, 5600SXT	\$65.01	\$55.73	\$52.94	\$51.08
44147	TRANSFORMER, 24V, 9.6VA; 5600SXT	\$30.50	\$26.15	\$24.84	\$23.97

5800 / 5810 / 5812

Part #	Description	1±	4±	8±
61957	PANEL GEAR KIT 5800/5810/5812	\$67.18	\$64.64	\$62.11
60626	METER ASSY, TURBINE, 3/4", 5800 LXT/SXT/XTR2	\$116.70	\$112.29	\$107.89
60086-50	METER ASSY, 3/4"; PDL; ELECTRONIC, 5800 SXT/XTR2	\$126.34	\$121.57	\$116.81
61837	PISTON & SEAL KIT ASSY, DOWNFLOW, 5800	\$70.16	\$67.51	\$64.86
61838	PISTON & SEAL KIT ASSY, UPFLOW, 5800	\$76.78	\$73.88	\$70.98
61956-01	PISTON & SEAL KIT ASSY, DOWNFLOW, 5810	\$47.90	\$46.09	\$44.28
61956-02	PISTON & SEAL KIT ASSY, UPFLOW, 5810	\$44.63	\$42.95	\$41.26
61956-03	PISTON & SEAL KIT ASSY, FILTER, 5810	\$56.19	\$54.07	\$51.95
61960-01	PISTON & SEAL KIT ASSY, DOWNFLOW, 5812	\$51.65	\$49.70	\$47.76
61960-02	PISTON & SEAL KIT ASSY, UPFLOW, 5812	\$55.31	\$53.22	\$51.14
61960-03	PISTON & SEAL KIT ASSY, FILTER, 5812	\$53.44	\$51.43	\$49.41
60032	BRINE VALVE ASSY, 4600/5600/5800	\$9.34	\$8.99	\$8.63
60016-01	BRINE VALVE ASSY, 5810/5812/7000, 560CD	\$16.36	\$15.74	\$15.12
60705-00	DLFC, PLASTIC, BLANK, 1/2QC X 1/2FPT, 2510/5000/5800	\$5.74	\$5.52	\$5.31
18312	DLFC HOUSING RETAINER CLIP, 2510/5000/5800	\$0.71	\$0.68	\$0.65
61455-00	DLFC, 3/4" ELBOW, BLANK, 7000/5810 (1.5 - 7.0 GPM)	\$5.08	\$4.89	\$4.70
61971-00	DLFC, 1" NPT, BLANK, 5812	\$8.00	\$7.70	\$7.39
62076	TIMER ASSY, SXT, 5800/5810/5812	\$106.54	\$102.52	\$98.50
61931-03	TIMER ASSY, 5800/5810/5812 XTR2; MULTI LANGUAGE	\$233.59	\$224.78	\$215.96
44161	POWER SUPPLY, US, 12V DC 3M, 2A	\$17.62	\$16.96	\$16.29

Part #	Description	1±	10±	24±	48±
61919	METER ASSY, 1-1/4", 5810/5812	\$38.12	\$32.67	\$31.04	\$29.95
61919	METER ASSY, 1-1/4", 5810/5812	\$38.12	\$32.67	\$31.04	\$29.95
18277	CAP, INJECTOR 5800/5000	\$4.25	\$3.65	\$3.46	\$3.34
61456-00	DLFC, 1" STRAIGHT, BLANK, 7000/5810 (8 - 25 GPM)	\$5.63	\$4.83	\$4.59	\$4.43
61977-00	DLFC, 1.25" NPT, BLANK, 5812 (USE WITH .6-45 GPM)	\$7.54	\$6.46	\$6.14	\$5.92



Softeners / POE

9000 / 9100 / 9500

Part #	Description	1±	4±	8±
62103-76	PWRHD, TWIN, SXT; NO TRANS., COVER, MTR CABLE	\$438.90	\$422.34	\$405.77
62103-77	PWRHD, TWIN, XT; NO TRANS., COVER, MTR CABLE	\$948.69	\$912.89	\$877.10
60400-001	PISTON ASSY, 9000/9100, UPPER	\$48.90	\$47.06	\$45.21
60401-001	PISTON ASSY, 9000/9100, LOWER	\$90.01	\$86.62	\$83.22
60125	SEAL & SPACER KIT; 9000/9100 UPPER	\$14.98	\$14.41	\$13.85
60421	SEAL & SPACER KIT; 9000/9100; LOWER	\$43.49	\$41.85	\$40.21
60108-02	PISTON ASSY, 9500, UPPER	\$66.23	\$63.73	\$61.23
60109-02	PISTON ASSY, 9500, LOWER	\$100.14	\$96.36	\$92.58
60133-20	SEAL & SPACER KIT,9500,LOWER,PLASTIC	\$194.82	\$187.47	\$180.11
60134-20	SEAL & SPACER KIT,9500,UPPER,PLASTIC	\$84.70	\$81.51	\$78.31
60350	BRINE VALVE ASSY, 9000/9100	\$13.04	\$12.55	\$12.06
60037	BRINE VALVE; 1600/9500; 3/8"	\$43.68	\$42.03	\$40.38
60039-20	BRINE VALVE ASSY,1700/9500; 1/2"; 2.0GPM	\$126.71	\$121.93	\$117.15
60086	METER ASSY,5600/9000/9100 3/4" STD	\$102.30	\$98.44	\$94.58
60389	METER ASSY,9000/9100; 1" STD; BRASS;PDL	\$510.50	\$491.24	\$471.97
60626	METER ASSY,TURBINE,ELECTRONIC, 3/4"	\$116.70	\$112.29	\$107.89
14864-01	ADAPTER ASSY,2ND TANK, 9000, W/O-RINGS	\$146.18	\$140.66	\$135.15
60425-12	TUBE ASSY,9100,6-12" TANK	\$38.49	\$37.04	\$35.59
60425-16	TUBE ASSY,9100,13-16" TANK	\$42.01	\$40.43	\$38.84
42777	TIMER ASSY; SXT; 9000/9100/9500	\$170.91	\$164.46	\$158.01
42466-02	TIMER ASSY XT; LEFT HAND; 9000/9100/9500	\$460.95	\$443.55	\$426.16

Part #	Description	1±	10±	24±	48±
60390	METER ASSY,9000/9100; 1" EXT; BRASS;PDL	\$476.18	\$408.15	\$387.74	\$374.14
16916-01	ADAPTER, 9500, 2ND TANK, MACHD W/O O-RINGS	\$178.74	\$165.72	\$157.44	\$149.15

Commercial Valve Parts and Service Assemblies

Part #	Description	1±	4±	8±
60029	BRINE VALVE, 1600 SHORT STEM,, LESS BLFC	\$45.69	\$43.97	\$42.24
60029-010	BRINE VALVE,1600,SHORT STEM 0.25 GPM	\$50.34	\$48.44	\$46.55
60029-020	BRINE VALVE,1600,SHORT STEM 0.50 GPM	\$51.67	\$49.72	\$47.77
60029-030	BRINE VALVE,1600,SHORT STEM 1.0GPM	\$46.62	\$44.86	\$43.10
60034-00	BRINE VALVE, 1700,BLANK	\$115.27	\$110.92	\$106.57
60034-20	BRINE VALVE, 1700, 2.0GPM	\$113.07	\$108.80	\$104.54
60034-30	BRINE VALVE, 1700, 3.0GPM	\$119.96	\$115.43	\$110.91
60036-02	BRINE VALVE, 1800, DESIGN 3	\$280.63	\$270.04	\$259.45
42778	TIMER ASSY, SXT, 2510/2750/2850/2850s	\$167.21	\$160.90	\$154.60
44144	TRANSFORMER, US, 24V,40VA	\$77.34	\$74.42	\$71.50
62115	TIMER ASSY,3200NXT2, RIGHT HINGD 27/28/29/31/39	\$320.41	\$308.32	\$296.22
62115-01	TIMER ASSY, NXT2, 2815	\$351.43	\$338.17	\$324.91
62121-01	CONVERSION KIT,NXT2,US	\$375.03	\$360.88	\$346.73
44164	POWER SUPPLY, US, 24V DC 2.7A, 3200 NXT2	\$55.35	\$53.26	\$51.18
19791-02	METER CABLE ASSY,TURBINE 35"	\$26.12	\$25.14	\$24.15
61560-07	METER ASSY, IN-LINE, TURBINE, W/ 1"NPT BRS	\$281.45	\$270.83	\$260.20
61560-09	METER ASSY, IN-LINE, TURBINE, W/1 1/2"NPT	\$269.42	\$259.25	\$249.09

Part #	Description	1±	10±	24±	48±
19121-10	METER CABLE ASSY, ELECTRONIC PADDLEWHEEL, 303.5"	\$57.93	\$49.65	\$47.17	\$45.52

COMMERCIAL STAINLESS PADDLEWHEEL METERS

* New universal cap for use with electronic or electromechanical systems

* Turbine style meter cable required for electronic systems

Part #	Description	1±	4±	8±
61932-10	METER ASSEMBLY, 1" NPT, STD RANGE, UNIVERSAL CAP	\$400.62	\$385.50	\$370.38
61933-10	METER ASSEMBLY, 1-1/2" NPT, STD RANGE,UNIVSL CAP	\$395.10	\$380.19	\$365.29
61934-10	METER ASSEMBLY, 2" NPT, STD RANGE, UNIVERSAL CAP	\$403.48	\$388.26	\$373.03
61935-10	METER ASSEMBLY, 3" NPT, STD RANGE, UNIVERSAL CAP	\$1,163.39	\$1,119.49	\$1,075.58



Meter Assembly



Softeners / POE



(13061)



(11098)

Stuffer and Puller Tools

Part #	Description	1+	4+	8+
13061	PULLER TOOL 5600, 2510, 2750, 2900 UPPER	\$62.79	\$60.42	\$58.06
17623	PULLER TOOL 2850,9500	\$92.37	\$88.89	\$85.40
12682	PULLER TOOL, 2900 LOWER, 3150, 3900 UPPER	\$210.54	\$202.59	\$194.65
12763	STUFFER TOOL ,5600, 9000, 9100	\$71.62	\$68.92	\$66.21
11098	STUFFER TOOL 2510, 2750, 2900 UPPER	\$33.10	\$31.85	\$30.61
16516	STUFFER TOOL 2850, 9500	\$47.23	\$45.45	\$43.66
12683	STUFFER TOOL ,2900 LOWER, 3150, 3900 UPPER	\$157.54	\$151.60	\$145.65

PISTON ASSEMBLIES AND SEAL & SPACER KITS 2750

Part #	Description	1+	10+	24+	48+
60090HF	PISTON ASSY,2750/2900 UPPER	\$66.88	\$57.32	\$54.46	\$52.55

Part #	Description	1+	4+	8+
60101-01	PISTON ASSY, 2510/2750, NHWBP	\$213.83	\$205.76	\$197.69
60121	SEAL & SPACER KIT 2510/2750/2900 UPPER	\$17.07	\$16.43	\$15.78

2815

Part #	Description	1+	4+	8+
62050-01	PISTON ASSY, 2815, HWBP	\$78.11	\$75.16	\$72.21
62050-02	PISTON ASSY, 2815, NHWBP	\$166.62	\$160.33	\$154.04
62017	SEAL & SPACER KIT,2815	\$64.57	\$62.13	\$59.70

2850

Part #	Description	1+	4+	8+
60105-001	PISTON ASSY, 2850, HWBP	\$68.80	\$66.20	\$63.61
60114-01	PISTON ASSY, 2850, NHWBP	\$219.90	\$211.60	\$203.30
60129	SEAL & SPACER KIT,2850, BRASS SPACER, HOT & COLD	\$69.48	\$66.86	\$64.23
60129-20	SEAL & SPACER KIT,2850, PLASTIC SPACER, MS1050	\$87.69	\$84.38	\$81.07

2850s

Part #	Description	1+	10+	24+	48+
61630-00	PISTON ASSY, 2850S, STD, HWBP	\$69.16	\$59.28	\$56.32	\$54.34

2900 (Older Models with 2 piece valve casting)

Part #	Description	1+	10+	24+	48+
60090HF	PISTON ASSY; 2750/2900 UPPER	\$66.88	\$57.32	\$54.46	\$52.55

Part #	Description	1+	4+	8+
61540	PISTON ASSY, 2900s UPPER, DOWNFLOW	\$58.86	\$56.64	\$54.41
61555	PISTON ASSY; 2900/2900s LOWER, NHWBP	\$198.31	\$190.83	\$183.34
61550	PISTON ASSY; 2900/2900s LOWER, HWBP	\$194.94	\$187.58	\$180.23
60121	SEAL & SPACER KIT; 2510/2750/2900 UPPER	\$17.07	\$16.43	\$15.78
60128	SEAL & SPACER KIT; 2900/2900s LOWER	\$26.58	\$25.58	\$24.57

2900s (New Models with 1 piece valve casting)

Part #	Description	1+	4+	8+
61555	PISTON ASSY, 2900/2900s LOWER, NHWBP	\$198.31	\$190.83	\$183.34
61550	PISTON ASSY, 2900/2900s LOWER, HWBP	\$194.94	\$187.58	\$180.23
61530	SEAL & SPACER KIT; 2900S,UPPER	\$23.76	\$22.86	\$21.97
60128	SEAL & SPACER KIT; 2900 LOWER	\$26.58	\$25.58	\$24.57

3150

Part #	Description	1+	4+	8+
60106-00	PISTON ASSY, 3150/3900 UPPER	\$143.04	\$137.64	\$132.25
60113-01	PISTON ASSY, 3150, NHWBP ,DOWNFLOW	\$267.79	\$257.69	\$247.58
60131	SEAL & SPACER KIT, 3150/3900 UPPER	\$47.69	\$45.89	\$44.10

3900

Part #	Description	1+	4+	8+
60106-00	PISTON ASSY, 3150/3900 UPPER	\$143.04	\$137.64	\$132.25
60107-00	PISTON ASSY,3900 LOWER, HWBP	\$304.83	\$293.33	\$281.82
60107-10	PISTON ASSY,3900 LOWER, NHWBP	\$282.52	\$271.86	\$261.20
60131	SEAL & SPACER KIT, 3150/3900 UPPER	\$47.69	\$45.89	\$44.10
60132	SEAL & SPACER KIT, 3900 LOWER	\$55.38	\$53.29	\$51.20



VALUMAX™ AUTOTROL™ WATER SOFTENERS



Will Call / Truck Shipments Only

Softeners / POE

VALUMAX 255 Water Softeners

- Composite media tank
- Heavy duty blowmolded brine tank
- Full 3/4" flow throughout system
- Upper distributor basket
- CSA B483.1
- 8% crosslink resin
- Brine safety valve with air check
- 12VAC UL/CSA electrical system with 12' cord
- 5 year warranty on control
- 10 year warranty on composite media tank



255 Easy-iQ Control Valve

- Time-tested flapper provides frictionless sealing for longer service life
- Fiber-reinforced polymer valve body for superior strength and durability, non-corrosive, and UV-resistant
- Optical sensor for precision cycle positioning
- Designed with double backwash for reduced hardness leakage
- Fully adjustable 5- or 8- cycle control for efficient and reliable water treatment system
- Continuous service flow rate of 15.5 GPM with a backwash of 6 GPM
- Backwash capability accommodates softener tanks up to 14"
- Designed for single or multiple tank systems
- Super capacitor keeps time of day and stores memory in the event of power outages
- Environmental protective cover for water resistance, corrosion resistance, and UV stability
- Historical data on valve performance



- Install parts (bypass valves, tube adapter kits, drain fittings) are **sold separately** and are listed on page 32.
- Units up to 2 cubic feet (12" x 52" media tank) are shipped with media loaded. Larger systems have media packaged separately which must be loaded on site.

Valumax 255 EiQ - Electronic Time Clock Control

Part #	Description	1±	3±	6±
CVM-.75-255-EIQ-TC	.75CUFT; 30K; 255-EIQ; TIME CLOCK; RT844; BT15x32	\$443.95	\$409.80	\$389.31
CVM-1.0-255-EIQ-TC	1.0CUFT; 30K; 255-EIQ; TIME CLOCK; RT948; BT15x32	\$466.59	\$430.70	\$409.16
CVM-1.25-255-EIQ-TC	1.25CUFT; 30K; 255-EIQ; TIME CLOCK; RT1047; BT15x32	\$479.45	\$442.57	\$420.44
CVM-1.5-255-EIQ-TC	1.5CUFT; 30K; 255-EIQ; TIME CLOCK; RT1054; BT15x32	\$492.74	\$454.83	\$432.09
CVM-2.0-255-EIQ-TC	2.0CUFT; 30K; 255-EIQ; TIME CLOCK; RT1252; BT15x32	\$539.70	\$498.18	\$473.28
CVM-2.5-255-EIQ-TC	2.5CUFT; 75K; 255-EIQ; TIME CLOCK; RT1354; BT17x36	\$610.71	\$563.73	\$535.55
CVM-3.0-255-EIQ-TC	3.0CUFT; 90K; 255-EIQ; TIME CLOCK; RT14x65; BT17x36	\$769.57	\$710.37	\$674.86

Valumax 255 EiQ - Electronic Metered Control

Part #	Description	1±	3±	6±
CVM-.75-255-EIQ-MI	.75CUFT; 30K; 255-EIQ; MTR; RT844; BT15x32	\$548.13	\$505.97	\$480.67
CVM-1.0-255-EIQ-MI	1.0CUFT; 30K; 255-EIQ; MTR; RT948; BT15x32	\$570.76	\$526.86	\$500.52
CVM-1.25-255-EIQ-MI	1.25CUFT; 30K; 255-EIQ; MTR; RT1047; BT15x32	\$583.63	\$538.74	\$511.80
CVM-1.5-255-EIQ-MI	1.5CUFT; 30K; 255-EIQ; MTR; RT1054; BT15x32	\$596.91	\$551.00	\$523.45
CVM-2.0-255-EIQ-MI	2.0CUFT; 30K; 255-EIQ; MTR; RT1252; BT15x32	\$643.88	\$594.35	\$564.63
CVM-2.5-255-EIQ-MI	2.5CUFT; 75K; 255-EIQ; MTR; RT1354; BT17x36	\$714.89	\$659.90	\$626.90
CVM-3.0-255-EIQ-MI	3.0CUFT; 90K; 255-EIQ; MTR; RT14x65; BT17x36	\$873.75	\$806.54	\$766.22

Valumax Cabinet 255 EiQ - Electronic Metered Control

Part #	Description	1±	3±	6±
CVM-WSCAB-.50-EIQ-MI	.50CUFT; 15K; WS CAB; 255 EIQ MTR; RT10X18	\$566.43	\$522.86	\$496.72
CVM-WSCAB-1.0-EIQ-MI	1.0CUFT; 30K; WS CAB; 255 EIQ MTR; RT10X35	\$642.26	\$592.86	\$563.22



Softeners / POE



Will Call / Truck Shipments Only

VALUMAX 268 Water Softeners

- Composite media tank
- Heavy duty blowmolded brine tank
- Full 3/4" flow throughout system
- Upper distributor basket
- CSA B483.1
- 8% crosslink resin
- Brine safety valve with air check
- 12VAC UL/CSA electrical system with 12' cord
- 5 year warranty on control
- 10 year warranty on composite media tank

263/268 Easy-iQ Control Valve

Time-tested flapper provides frictionless sealing for longer service life

- Fiber-reinforced polymer valve body for superior strength and durability, non-corrosive, and UV-resistant
- Optical sensor for precision cycle positioning
- Designed with double backwash for reduced hardness leakage
- Fully adjustable 5- or 8-cycle control for efficient and reliable water treatment system
- Continuous service flow rate of 25 GPM with a backwash of 20 GPM
- Backwash capability accommodates softener and filter tanks up to 18" in diameter
- Super capacitor keeps time of day and stores memory in the event of power outages
- Environmental protective cover for water resistance, corrosion resistance, and UV stability
- Soft water refill for a cleaner brine tank
- Historical data on valve performance



- Install parts (bypass valves, tube adapter kits, drain fittings) are **sold separately** and are listed on page 32.
- Units up to 2 cubic feet (12" x 52" media tank) are shipped with media loaded. Larger systems have media packaged separately which must be loaded on site.

Valumax 268 EiQ - Electronic Time Clock Control

Part #	Description	1±	3±	6±
CVM-.75-268-EIQ-TC	.75CUFT; 30K; 268-EIQ; TIME CLOCK; RT844; BT15x32	\$466.25	\$430.38	\$408.87
CVM-1.0-268-EIQ-TC	1.0CUFT; 30K; 268-EIQ; TIME CLOCK; RT948; BT15x32	\$488.88	\$451.27	\$428.71
CVM-1.25-268-EIQ-TC	1.25CUFT; 30K; 268-EIQ; TIME CLOCK; RT1047; BT15x32	\$515.04	\$475.42	\$451.65
CVM-1.5-268-EIQ-TC	1.5CUFT; 30K; 268-EIQ; TIME CLOCK; RT1054; BT15x32	\$515.04	\$475.42	\$451.65
CVM-2.5-268-EIQ-TC	2.5CUFT; 75K; 268-EIQ; TIME CLOCK; RT1354; BT17x36	\$633.74	\$584.99	\$555.74
CVM-3.0-268-EIQ-TC	3.0CUFT; 90K; 268-EIQ; TIME CLOCK; RT14x65; BT17x36	\$792.75	\$731.77	\$695.18

Part #	Description	1±
CVM-2.0-268-EIQ-TC	2.0CUFT; 30K; 268-EIQ; TIME CLOCK; RT1252; BT15x32	\$561.99

Valumax 268 EiQ - Electronic Metered Control

Part #	Description	1±	3±	6±
CVM-.75-268-EIQ-MI	.75CUFT; 30K; 268-EIQ; MTR; RT844; BT15x32	\$581.81	\$537.06	\$510.21
CVM-1.0-268-EIQ-MI	1.0CUFT; 30K; 268-EIQ; MTR; RT948; BT15x32	\$604.43	\$557.94	\$530.04
CVM-1.25-268-EIQ-MI	1.25CUFT; 30K; 268-EIQ; MTR; RT1047; BT15x32	\$617.31	\$569.82	\$541.33
CVM-1.5-268-EIQ-MI	1.5CUFT; 30K; 268-EIQ; MTR; RT1054; BT15x32	\$630.60	\$582.09	\$552.98
CVM-2.0-268-EIQ-MI	2.0CUFT; 30K; 268-EIQ; MTR; RT1252; BT15x32	\$677.54	\$625.42	\$594.15



ULTRAMAX™ WATER SOFTENERS

Will Call / Truck Shipments Only



Ultramax™ is GWW's EXCLUSIVE water softener dealer program for all of the USA & Canada.

Softeners / POE

Ultramax Standard Features

- Composite media tank with attractive and durable chrome tank jacket
- Heavy duty blowmolded brine tank
- 12VAC UL/CSA electrical system with 12' cord
- Soft water refill for a cleaner brine tank
- Full 1" flow throughout system
- Internal turbine meter assembly
- Fully adjustable 8 cycle control for efficient and reliable water treatment system
- Limited Lifetime Warranty on Salt tank, Resin tank, ion exchange resin and control valve body
- 7 year warranty on electronic control and all other parts
- 8% crosslink resin
- Brine safety valve with air check
- Upper distributor basket
- Fully programmable control
- Up to 25 GPM continuous service flow
- Quick and simple bypass installation



Ultramax 268/860 Features

- Efficiency rated to 5,500 grains/pound of salt
- Quick set up to high efficiency settings.
- Fully programmable cycle times allowing the system to be tailored to practically any water condition.
- Refill sensor probe test salinity of the brine solution during every regeneration and generates an on screen alert if no salt is present.
- Refill sensor probe creates chlorine dioxide during each regeneration cycle to sanitize the resin bed.
- Multi-language display including English, French, and Spanish
- Exclusive color LED display with graphical indicators for system capacity remaining and water flow.
- Programmable service reminder generates on screen notification for scheduled maintenance on installed equipment.
- In service display shows time of day with current flow rate and remaining capacity available at the touch of a button.
- 28 day variable reserve learns and reacts to changing water usage patterns
- Full system diagnostics: totalizer, peak flow, last regeneration, last service, and average water use for each day of the week.

Install parts (bypass valves, tube adapter kits, drain fittings) are sold separately.



860 Controller



1265 Bypass (1040930)



1" Copper Tube Adapter Kit (1001670)

Ultramax Logix 268/860

Part #	Description	1±	3±	6±
UM-8100	1.0CUFT; 9X48; 268/860 LOGIX	\$674.16	\$622.30	\$591.19
UM-8150	1.5CUFT; 10X54; 268/860 LOGIX	\$698.12	\$644.42	\$612.20
UM-8200	2.0CUFT; 12X52; 268/860 LOGIX	\$832.71	\$768.65	\$730.22

268 Valve - Bypass Option

Part #	Description	1±	4±	8±
1040930	1265 BYPASS VALVE	39.12429	\$37.65	36.17

Drain Fitting

Part #	Description	1±	10±	24±	48±
3EL3412F	3/4"FX1/2"HB POLYPRO ELBOW	\$2.55	\$2.21	\$2.04	\$1.94

Tube Adapter Kits - (2pk)

Part #	Description	1±	4±	8±
1001606	3/4" COPPER TUBE ADAPTER KIT	19.14329	\$18.42	17.7
1001670	1" COPPER TUBE ADAPTER KIT	22.69959	\$21.84	20.99
1001613	3/4" CPVC TUBE ADAPTER KIT	24.30549	\$23.39	22.47
1001769	3/4" NPT ABS PLASTIC TUBE ADAPTER KIT	19.62029	\$18.88	18.14
1001603	1" NPT ABS PLASTIC TUBE ADAPTER KIT	21.26859	\$20.47	19.66
1041210	1-1/4" COPPER TUBE KIT [2PK]	\$24.59	\$23.66	22.74



Softeners / POE

VALUMAX™ AUTOTROL™ BACKWASHING FILTER SYSTEMS



- Filter media selection is based on application.
- Media data sheets are available through customer service if required.
- Backwashing filters shown represent common sizes and media choices.
- Other sizes and media selections are available.

• Install parts (bypass valves, tube adapter kits, drain fittings) are **sold separately** and are listed on next page 33.
 • Backwash flow rates should be considered for drain pipe sizing and should typically be 3/4" OD or larger.
 • Units up to 2 cubic feet (12" x 52" media tank) are shipped with media loaded. Larger systems have media packaged separately which must be loaded on site.



Carbon Filters

- Chlorine reduction
- Taste and odor reduction
- Reduction of chemical by-products of chlorination, pesticides, herbicides and other organic chemicals
- 3 cycle operation - Backwash, Fast rinse, Service
- EiQ professional electronic time clock control
- Carbon works by chemical adsorption, and will need periodic replacement to maintain effectiveness

Valumax 263 EiQ Time Clock Control - Backwashing Filters Carbon Filters

Part #	Description	1+	3+	6+
CFM-1.0-263-CARBON	1.0CUFT; CARBON; 263-EIQ-TC; RT 9X48	\$417.97	\$385.82	\$366.53
CFM-1.5-263-CARBON	1.5CUFT; CARBON; 263-EIQ-TC; RT 10X54	\$439.72	\$405.89	\$385.60
CFM-2.0-263-CARBON	2.0CUFT; CARBON; 263-EIQ-TC; RT 12X52	\$504.96	\$466.12	\$442.81
CFM-3.0-263-CARBON	3.0CUFT; CARBON; 263-EIQ-TC; RT 14X65	\$742.99	\$685.83	\$651.54
CFM-4.0-263-CARBON	4.0CUFT; CARBON; 263-EIQ-TC; RT 16X65	\$804.56	\$742.67	\$705.53

Catalytic Carbon Filters

- Chloramine reduction
- Iron and Hydrogen Sulfide removal (typically requires air injection)
- 3 cycle operation - Backwash, Fast rinse, Service
- EiQ professional electronic time clock control

Catalytic Carbon Filters - Chloramine Reduction

Part #	Description	1+	3+	6+
CFM-1.0-263-MC1240	1.0CUFT; CATALYTIC CARB; 263-EIQ-TC; RT 9X48	\$452.14	\$417.36	\$396.49
CFM-1.5-263-MC1240	1.5CUFT; CATALYTIC CARB; 263-EIQ-TC; RT 10X54	\$502.58	\$463.92	\$440.73
CFM-2.0-263-MC1240	2.0CUFT; CATALYTIC CARB; 263-EIQ-TC; RT 12X52	\$588.76	\$543.47	\$516.29
CFM-3.0-263-MC1240	3.0CUFT; CATALYTIC CARB; 263-EIQ-TC; RT 14X65	\$868.72	\$801.89	\$761.80
CFM-4.0-263-MC1240	4.0CUFT; CATALYTIC CARB; 263-EIQ-TC; RT 16X65	\$972.20	\$897.41	\$852.54

Nexsand Filters

- Turbidity reduction providing filtration down to 3-5 micron
- High service flow
- Removal of precipitated material after chemical feed (chlorine, peroxide, etc)
- Durable, long lasting media (typically 5+ years)
- 3 cycle operation - Backwash, Fast rinse, Service
- EiQ professional electronic time clock control

Nexsand Filters

Part #	Description	1+	3+	6+
CFM-.75-263-NEXSAND	.75CUFT; NEXSAND; 263-EIQ-TC; RT 8X44	\$365.63	\$337.50	\$320.63
CFM-1.0-263-NEXSAND	1.0CUFT; NEXSAND; 263-EIQ-TC; RT 9X48	\$396.92	\$366.39	\$348.07
CFM-1.5-263-NEXSAND	1.5CUFT; NEXSAND; 263-EIQ-TC; RT 10X54	\$413.01	\$381.24	\$362.18
CFM-2.0-263-NEXSAND	2.0CUFT; NEXSAND; 263-EIQ-TC; RT 12X52	\$472.70	\$436.34	\$414.53
CFM-3.0-263-NEXSAND	3.0CUFT; NEXSAND; 263-EIQ-TC; RT 14X65	\$664.19	\$613.10	\$582.44



Greensand Plus Filters

- Removal of Iron, Manganese, Hydrogen Sulfide, Arsenic and Radium
- Effective over a broad pH range
- Batch regeneration
- Includes 10"x16" potassium permanganate feeder tank.
- 5 cycle operation - Backwash, Chem Draw, Fast rinse, Refill, Service
- EiQ professional electronic time clock control

Greensand Filters

Part #	Description	1±	3±	6±
CFM-1.0-268-GRNSAND	1.0CUFT; GRNSAND; 268-EIQ-TC; RT 9X48	\$533.10	\$492.09	\$467.48
CFM-1.5-268-GRNSAND	1.5CUFT; GRNSAND; 268-EIQ-TC; RT 10X54	\$591.36	\$545.87	\$518.57
CFM-2.0-268-GRNSAND	2.0CUFT; GRNSAND; 268-EIQ-TC; RT 12X52	\$672.74	\$620.99	\$589.94

Birm Filters & Air Injection Parts

- Iron and Manganese removal (requires presence of dissolved oxygen in water)
- Chemical free operation
- Typically used with air injector (installed ahead of well pressure tank) and air contact tank with off gas vent.
- Not suitable for use with chlorine or other chemical feed systems.
- 3 cycle operation - Backwash, Fast rinse, Service
- EiQ professional electronic time clock control

Birm Filters & Air Injection Parts (Not for sale in California)

Part #	Description	1±	3±	6±
CFM-1.0-263-BIRM	1.0CUFT; BIRM; 263-EIQ-TC; RT948	\$422.25	\$389.77	\$370.28
CFM-1.5-263-BIRM	1.5CUFT; BIRM; 263-EIQ-TC ; RT1054	\$472.68	\$436.32	\$414.51
CFM-2.0-263-BIRM	2.0CUFT; BIRM; 263-EIQ-TC; RT1252	\$530.31	\$489.52	\$465.05

VALUMAX™ AUTOTROL™ INSTALL PARTS



Bypass Valves



1265 Bypass
(1040930)

Part #	Description	1±	4±	8±
1040769	256 BYPASS; (FITS ALL 255 UNITS)	\$27.60	\$26.56	25.52
1040930	1265 BYPASS; (FITS ALL 268 UNITS)	\$39.12	\$37.65	36.17

Tube Adapter Kits - (2pk)



1" Copper Tube Adapter Kit
(1001670)

Part #	Description	1±	4±	8±
1001606	3/4" COPPER TUBE ADAPTER KIT	\$19.14	\$18.42	17.7
1001670	1" COPPER TUBE ADAPTER KIT	\$22.70	\$21.84	20.99
1001613	3/4" CPVC TUBE ADAPTER KIT	\$24.31	\$23.39	22.47
1001769	3/4" MPT ABS PLASTIC TUBE ADAPTER KIT	\$19.62	\$18.88	18.14
1001603	1" MPT ABS PLASTIC TUBE ADAPTER KIT	\$21.27	\$20.47	19.66
1001603	1" MPT ABS PLASTIC TUBE ADAPTER KIT	\$21.27	\$20.47	19.66
1041210	1-1/4" COPPER TUBE KIT [2PK]	\$24.59	\$23.66	22.74

Part #	Description	1±	10±	24±	48±
1001614	1" CPVC TUBE ADAPTER KIT	\$28.09	\$24.08	22.87	\$22.07

Drain Fittings



(3EL3412F)

Part #	Description	1±	10±	24±	48±
462088	1/2" F X 1/2" HB POLYPRO ELBOW - 255 UNITS	\$1.61	\$1.42	\$1.33	\$1.23
3EL3412F	3/4" F X 1/2" HB POLYPRO ELBOW 263/268	\$2.55	\$2.21	\$2.04	\$1.94



Softeners / POE

AUTOTROL® VALVES

255 EIQ 5 Cycle Softener Control Valves

Part #	Description	1±	4±	8±
V255EIQ529	255 EIQ TIME CLOCK (33 BLFC; NO INJ/BW) WITH CVR & US TSF	\$220.39	\$212.08	\$203.76
V255EIQ533	255 EIQ METERED (33 BLFC; NO INJ/BW) WITH CVR & US TSF	\$313.99	\$302.14	\$290.30



255 Valve

268 EIQ 5 Cycle Softener Control Valves

Part #	Description	1±	4±	8±
V268EIQ512	268 EIQ TIME CLOCK (33 BLFC; J INJ/#10 BW) WITH CVR & US TSF	\$244.80	\$235.56	\$226.33
V268EIQ521	268 EIQ METERED (33 BLFC; NO INJ/BW) WITH CVR & US TSF	\$344.83	\$331.82	\$318.81



263/268 Valve

263 EIQ 3 Cycle Filter Valves

Part #	Description	1±	4±	8±
V263EIQ510	263 EIQ TIME CLOCK (PLUG BLFC; J INJ/#14 BW) WITH CVR & US TSF	\$242.40	\$233.25	\$224.11
V263EIQ511	263 EIQ METERED (PLUG BLFC; J INJ/#14 BW) WITH CVR & US TSF	\$352.75	\$339.44	\$326.12

SOFTENER VALVE CONVERSION PARTS

7" DIAMETER WATER SOFTENER (255 OR 268)

		1±	4±	8±
1000269	INJECTOR CAP	\$3.56	\$3.42	\$3.29
1035731	F INJECTOR, PEACH	\$5.36	\$5.16	\$4.96
1000209	BACKWASH ASSEMBLY #7 1.2GPM	\$8.54	\$8.22	\$7.90
1030502	BALL, BACKWASH FLOW CONTROL	\$0.79	\$0.76	\$0.73

8" DIAMETER WATER SOFTENER (255 OR 268)

		1±	4±	8±
1000269	INJECTOR CAP	\$3.56	\$3.42	\$3.29
1035732	G INJECTOR, TAN	\$5.90	\$5.68	\$5.46
1000210	BACKWASH ASSEMBLY #8 1.5GPM	\$7.41	\$7.13	\$6.86
1030502	BALL, BACKWASH FLOW CONTROL	\$0.79	\$0.76	\$0.73

9" DIAMETER WATER SOFTENER (255 OR 268)

		1±	4±	8±
1000269	INJECTOR CAP	\$3.56	\$3.42	\$3.29
1035733	H INJECTOR, LIGHT PURPLE	\$5.90	\$5.68	\$5.46
1000211	BACKWASH ASSEMBLY #9 2.2GPM	\$7.79	\$7.49	\$7.20
1030502	BALL, BACKWASH FLOW CONTROL	\$0.79	\$0.76	\$0.73

10" DIAMETER WATER SOFTENER (255 OR 268)

		1±	4±	8±
1000269	INJECTOR CAP	\$3.56	\$3.42	\$3.29
1035734	J INJECTOR, LIGHT BLUE	\$5.79	\$5.57	\$5.36
1000212	BACKWASH ASSEMBLY #10 2.7GPM	\$7.79	\$7.49	\$7.20
1030502	BALL, BACKWASH FLOW CONTROL	\$0.79	\$0.76	\$0.73

12" DIAMETER WATER SOFTENER (255 OR 268)

		1±	4±	8±
1000269	INJECTOR CAP	\$3.56	\$3.42	\$3.29
1035735	K INJECTOR, PINK	\$5.53	\$5.32	\$5.11
1000213	BACKWASH ASSEMBLY #12 3.9GPM	\$7.79	\$7.49	\$7.20
1030502	BALL, BACKWASH FLOW CONTROL	\$0.79	\$0.76	\$0.73

13" DIAMETER WATER SOFTENER (255 OR 268)

		1±	4±	8±
1000269	INJECTOR CAP	\$3.56	\$3.42	\$3.29
1035736	L INJECTOR, ORANGE	\$5.38	\$5.18	\$4.97
1000214	BACKWASH ASSEMBLY #13 4.5GPM (NO BALL REQ'D)	\$9.31	\$8.96	\$8.61

14" DIAMETER WATER SOFTENER (255 OR 268)

		1±	4±	8±
1000269	INJECTOR CAP	\$3.56	\$3.42	\$3.29
1035738	L INJECTOR, ORANGE	\$5.36	\$5.16	\$4.96
1000215	BACKWASH ASSEMBLY #14 5.3GPM (NO BALL REQ'D)	\$9.31	\$8.96	\$8.61

16" DIAMETER WATER SOFTENER (268 ONLY)

		1±	4±	8±
1000269	INJECTOR CAP	\$3.56	\$3.42	\$3.29
1035738	N INJECTOR, GREEN	\$5.36	\$5.16	\$4.96
1000269	BACKWASH PORT CAP (NEED EXTERNAL DLFC)	\$3.56	\$3.42	\$3.29
1030357	EXTERNAL DRAIN FLOW CONTROL; 7 GPM, 3/4"	\$18.34	\$17.65	\$16.96

18" DIAMETER WATER SOFTENER (268 ONLY)

		1±	4±	8±
1000269	INJECTOR CAP	\$3.56	\$3.42	\$3.29
1035739	Q INJECTOR, PURPLE	\$10.73	\$10.32	\$9.92
1000269	BACKWASH PORT CAP (NEED EXTERNAL DLFC)	\$3.56	\$3.42	\$3.29

21" DIAMETER WATER SOFTENER (268 ONLY)

		1±	4±	8±
1000269	INJECTOR CAP	\$3.56	\$3.42	\$3.29
1035884	Q INJECTOR, GREY	\$10.94	\$10.53	\$10.11
1000269	BACKWASH PORT CAP (NEED EXTERNAL DLFC)	\$3.56	\$3.42	\$3.29
1000406	EXTERNAL DRAIN FLOW CONTROL; 12 GPM, 1"	\$26.33	\$22.57	\$21.44



Softeners / POE

FILTER VALVE CONVERSION PARTS

		1±	4±	8±
1000269	BACKWASH PORT CAP (REQUIRED FOR ALL EXTERNAL DLFC)	\$3.56	\$3.42	\$3.29
1030355	ASSY;FLOW CONTROL;DRAIN; 5GPM - EXTERNAL	\$17.01	\$16.37	\$15.73
1030357	ASSY;FLOW CONTROL;DRAIN; 7GPM - EXTERNAL	\$18.34	\$17.65	\$16.96
1030360	ASSY;FLOW CONTROL;DRAIN; 10GPM - EXTERNAL	\$18.46	\$17.76	\$17.07
1000406	ASSY;FLOW CONTROL;DRAIN; 12GPM - EXTERNAL	\$26.33	\$22.57	\$21.44
1000407	ASSY;FLOW CONTROL;DRAIN; 15GPM - EXTERNAL	\$25.24	\$24.29	\$23.34
1000409	ASSY;FLOW CONTROL;DRAIN; 20GPM - EXTERNAL	\$18.59	\$15.93	\$15.14

Upper Basket

Part #	Description	1±	10±	24±	48±
05008102	UPPER BASKET TWIST-LOCK 1.05"	\$2.03	\$1.79	\$1.67	\$1.56



1265 Bypass
(1040930)

Bypass Valves

Part #	Description	1±	4±	8±
1040769	256 BYPASS; (FITS ALL 255 UNITS)	\$27.60	\$26.56	\$25.52
1040930	1265 BYPASS; (FITS ALL 268 UNITS)	\$39.12	\$37.65	\$36.17

Tube Adapter Kits - (2pk)

Part #	Description	1±	4±	8±
1001606	3/4" COPPER TUBE ADAPTER KIT	\$19.14	\$18.42	\$17.70
1001670	1" COPPER TUBE ADAPTER KIT	\$22.70	\$21.84	\$20.99
1001613	3/4" CPVC TUBE ADAPTER KIT	\$24.31	\$23.39	\$22.47
1001769	3/4" MPT ABS PLASTIC TUBE ADAPTER KIT	\$19.62	\$18.88	\$18.14
1001603	1" MPT ABS PLASTIC TUBE ADAPTER KIT	\$21.27	\$20.47	\$19.66
1041210	1-1/4" COPPER TUBE KIT [2PK]	\$24.59	\$23.66	\$22.74



1" Copper Tube Adapter Kit
(1001670)

Part #	Description	1±	10±	24±	48±
1001614	1" CPVC TUBE ADAPTER KIT	\$28.09	\$24.08	\$22.87	\$22.07

Brine Elbow Fittings

Part #	Description	1±	100±	500±	1000±
4564NO-BK	3/8X1/4 F ELB;N BLACK; 255 BRINE ELBOW	\$1.50	\$1.20	\$1.10	\$1.00
4566NO-BK	3/8X3/8 F ELB;N BLACK; 268/278 BRINE ELBOW	\$1.70	\$1.36	\$1.25	\$1.13



(3EL3412F)

Drain Fittings

Part #	Description	1±	10±	24±	48±
462088	1/2" F X 1/2" HB POLYPRO ELBOW - 255 VALVE	\$1.61	\$1.42	\$1.33	\$1.23
3EL3412F	3/4" F X 1/2" HB POLYPRO ELBOW 263/268 VALVE	\$2.55	\$2.21	\$2.04	\$1.94



AUTOTROL® PARTS AND ACCESSORIES

EiQ Parts

NEED CONTROLLER AND COVER TO UPGRADE ANY LOGIX 255/263/268/269/278

Part #	Description	1±	4±	8±
4000816	EiQ Cover Assy 255/263/268/269/278	\$6.28	\$6.04	\$5.81
4000817-01	EiQ Controller 255/263/268/269/278	\$137.23	\$132.05	\$126.87

255 Valve Parts

Part #	Description	1±	4±	8±
1035730	E INJECTOR W/O-RINGS 6" TANK, YELLOW	\$5.47	\$5.26	\$5.06
1035731	F INJECTOR W/O-RINGS 7" TANK, PEACH	\$5.36	\$5.16	\$4.96
1035732	G INJECTOR W/O-RINGS 8" TANK, TAN	\$5.90	\$5.68	\$5.46
1035733	H INJECTOR W/O-RINGS 9" TANK, Lt PURPLE	\$5.90	\$5.68	\$5.46
1035734	J INJECTOR W/O-RINGS 10" TANK, Lt BLUE	\$5.79	\$5.57	\$5.36
1035735	K INJECTOR W/O-RINGS 12" TANK, PINK	\$5.53	\$5.32	\$5.11
1035736	L INJECTOR W/O-RINGS 13 - 14" TANK, ORANGE	\$5.38	\$5.18	\$4.97
1000209	BACKWASH ASSEMBLY #7 1.2GPM	\$8.54	\$8.22	\$7.90
1000210	BACKWASH ASSEMBLY #8 1.5GPM	\$7.41	\$7.13	\$6.86
1000211	BACKWASH ASSEMBLY #9 2.2GPM	\$7.79	\$7.49	\$7.20
1000212	BACKWASH ASSEMBLY #10 2.7GPM	\$7.79	\$7.49	\$7.20
1000213	BACKWASH ASSEMBLY #12 3.9GPM	\$7.79	\$7.49	\$7.20
1000214	BACKWASH ASSEMBLY #13 4.5GPM	\$9.31	\$8.96	\$8.61
1000215	BACKWASH ASSEMBLY #14 5.3GPM	\$9.31	\$8.96	\$8.61
44149	TRANSFORMER 120V	\$12.97	\$12.48	\$12.00
1000226	SCREEN/CAP ASSEMBLY W/O-RING	\$3.32	\$3.19	\$3.07
1000250	VALVE DISK KIT; 255	\$21.57	\$20.76	\$19.94
1000269	INJECTOR CAP W/O-RING	\$3.56	\$3.42	\$3.29
1010154	O-RING; TANK ADAPTER	\$5.01	\$4.82	\$4.64
1030502	BALL, FLOW CONTROL	\$0.79	\$0.76	\$0.73
1032350	TURBINE ASSEMBLY 255 INC INSTALL KIT	\$33.95	\$32.67	\$31.39
1032416	AIR CHECK KIT 3/8" MALE	\$11.81	\$11.37	\$10.92
1032417	AIR CHECK KIT; 1/4" MALE	\$10.79	\$10.38	\$9.98
1040459	MANIFOLD O-RING KIT	\$3.96	\$3.81	\$3.66
1040524	256 BYPASS & TURBINE INSTALL KIT	\$10.58	\$10.18	\$9.79
1232370	O-RING, RISER TUBE, -318, EP	\$0.92	\$0.89	\$0.85
1234170	LOCK BAR SCREW; #8-18 .56" SELF TAP	\$0.63	\$0.61	\$0.58
1235341	SPRING, ONE PIECE, 253/255 LOGIX VALVE	\$6.27	\$6.04	\$5.80
1235353	CAM, 253/255 LOGIX VALVE, STD, BLACK	\$12.49	\$12.02	\$11.55
1235373	MODULE, SENSOR, PHOTO INTERRUPTER	\$10.22	\$9.84	\$9.45
1239752	KIT, AUX SWITCH, FRONT MTD, 5 AMP; LOGIX	\$37.79	\$36.37	\$34.94
1239754	KIT, AUX SWITCH, SIDE MTD, 5 AMP; LOGIX	\$36.78	\$35.39	\$34.00
1243510	REFILL CONTROL .33 GPM CONE STYLE	\$5.23	\$5.03	\$4.83
1267811	OUTDOOR COVER; 255/268 LOGIX PLT;OFF WHITE	\$12.22	\$11.76	\$11.29
3019221	MOTOR/OPTICAL CABLE/SENSOR LOGIX	\$55.20	\$53.12	\$51.04



Air Check Kit
(1032416)

Part #	Description	1±	10±	24±	48±
1001404	TANK ADAPTER O-RING KIT	\$7.83	\$6.71	\$6.38	\$6.15
1031402	LOCKING BAR, ENGLISH	\$8.38	\$7.19	\$6.83	\$6.59
1033784	255 TANK ADAPTER, NEW STYLE	\$90.96	\$77.96	\$74.07	\$71.47
1235446	TURBINE CABLE; 23" LOGIX	\$13.97	\$11.97	\$11.38	\$10.98
1236251	CAM, 255 LOGIX VALVE, TWIN, TAN	\$13.02	\$11.16	\$10.61	\$10.23
1239753	KIT, AUX SWITCH, SIDE MTD, 0.1 AMP; LOGIX	\$31.87	\$27.32	\$25.95	\$25.04
1244650	255 VALVE ASSY, W/O FLOW CONTROL; LOGIX	\$155.74	\$133.49	\$126.82	\$122.37

Part #	Description	1±	4±	8±
1236246	COVER,255/268 PERFORMA;LOGIX; DARK GREY	\$6.89	\$6.63	\$6.37

Performa 263/268/273/278 Parts

Part #	Description	1+	4+	8+
1035730	E INJECTOR W/O-RINGS 6" TANK, YELLOW	\$5.47	\$5.26	\$5.06
1035731	F INJECTOR W/O-RINGS 7" TANK, PEACH	\$5.36	\$5.16	\$4.96
1035732	G INJECTOR W/O-RINGS 8" TANK, TAN	\$5.90	\$5.68	\$5.46
1035733	H INJECTOR W/O-RINGS 9" TANK, Lt PURPLE	\$5.90	\$5.68	\$5.46
1035734	J INJECTOR W/O-RINGS 10" TANK, Lt BLUE	\$5.79	\$5.57	\$5.36
1035735	K INJECTOR W/O-RINGS 12" TANK, PINK	\$5.53	\$5.32	\$5.11
1035736	L INJECTOR W/O-RINGS 13 - 14" TANK, ORANGE	\$5.38	\$5.18	\$4.97
1035738	N INJECTOR W/O-RINGS 16" TANK, GREEN	\$5.36	\$5.16	\$4.96
1035739	Q INJECTOR W/O-RINGS 18" TANK, PURPLE	\$10.73	\$10.32	\$9.92
1035884	R INJECTOR W/O-RINGS 21" TANK, GREY	\$10.94	\$10.53	\$10.11



Performa 263/268/273/278 Parts Continued...



3/4" External Drain
Flow Control



Autotrol Valve Discs
(1041174)



Logix-Lid Cover
(1236246)



Magnum LOGIX 742

Part #	Description	1+	4+	8+
1000209	BACKWASH ASSEMBLY #7 1.2GPM	\$8.54	\$8.22	\$7.90
1000210	BACKWASH ASSEMBLY #8 1.5GPM	\$7.41	\$7.13	\$6.86
1000211	BACKWASH ASSEMBLY #9 2.2GPM	\$7.79	\$7.49	\$7.20
1000212	BACKWASH ASSEMBLY #10 2.7GPM	\$7.79	\$7.49	\$7.20
1000213	BACKWASH ASSEMBLY #12 3.9GPM	\$7.79	\$7.49	\$7.20
1000214	BACKWASH ASSEMBLY #13 4.5GPM	\$9.31	\$8.96	\$8.61
1000215	BACKWASH ASSEMBLY #14 5.3GPM	\$9.31	\$8.96	\$8.61
1030355	ASSY;FLOW CONTROL;DRAIN; 5GPM - EXTERNAL	\$17.01	\$16.37	\$15.73
1030357	ASSY;FLOW CONTROL;DRAIN; 7GPM - EXTERNAL	\$18.34	\$17.65	\$16.96
1030360	ASSY;FLOW CONTROL;DRAIN; 10GPM - EXTERNAL	\$18.46	\$17.76	\$17.07
1000407	ASSY;FLOW CONTROL;DRAIN; 15GPM - EXTERNAL	\$25.24	\$24.29	\$23.34
44149	TRANSFORMER, 120V	\$12.97	\$12.48	\$12.00
1000226	SCREEN/CAP ASSEMBLY W/O-RING	\$3.32	\$3.19	\$3.07
1000269	INJECTOR CAP W/O-RING	\$3.56	\$3.42	\$3.29
1010154	O-RING; TANK ADAPTER	\$5.01	\$4.82	\$4.64
1030334	PLUGGED BRINE REFILL CONTROL; 263/273	\$8.89	\$8.56	\$8.22
1030502	BALL, FLOW CONTROL	\$0.79	\$0.76	\$0.73
1033444	TURBINE ASSEMBLY, INTERNAL	\$15.66	\$15.07	\$14.48
1041174	VALVE DISC KIT	\$32.42	\$31.20	\$29.97
1232370	O-RING, RISER TUBE, -318, EP	\$0.92	\$0.89	\$0.85
1235339	SPRING,1PC,263-278 VALVE	\$7.20	\$6.93	\$6.66
1239752	KIT, AUX SWITCH, FRONT MTD, 5 AMP; LOGIX	\$37.79	\$36.37	\$34.94
1239754	KIT, AUX SWITCH, SIDE MTD, 5 AMP; LOGIX	\$36.78	\$35.39	\$34.00
1243510	REFILL CONTROL .33 GPM CONE STYLE	\$5.23	\$5.03	\$4.83
1267811	OUTDOOR COVER; 255/268 LOGIX PLT;OFF WHITE	\$12.22	\$11.76	\$11.29
3019221	MOTOR/OPTICAL CABLE/SENSOR LOGIX	\$55.20	\$53.12	\$51.04

Part #	Description	1+	10+	24+	48+
1000406	ASSY;FLOW CONTROL;DRAIN; 12GPM - EXTERNAL	\$26.33	\$22.57	\$21.44	\$20.69
1000409	ASSY;FLOW CONTROL;DRAIN; 20GPM - EXTERNAL	\$18.59	\$15.93	\$15.14	\$14.61
1035622	PERFORMA TANK RING	\$4.85	\$4.16	\$3.95	\$3.81
1235352	CAM, 263/268 PERFORMA LOGIX VALVE, STD, BLACK	\$14.00	\$12.00	\$11.40	\$11.00
1235446	TURBINE CABLE; 23" LOGIX	\$13.97	\$11.97	\$11.38	\$10.98
1237405	CAM, 273/278 PERFORMA LOGIX VALVE, STD, BROWN	\$14.00	\$12.00	\$11.40	\$11.00
1237406	CAM, 273/278 PERFORMA LOGIX VALVE, TWIN, TAN	\$17.61	\$15.09	\$14.34	\$13.84
1239753	KIT, AUX SWITCH, SIDE MTD, 0.1 AMP; LOGIX	\$31.87	\$27.32	\$25.95	\$25.04

Part #	Description	1+	4+	8+
1236246	COVER,255/268 PERFORMA;LOGIX; DARK GREY	\$6.89	\$6.63	\$6.37

MAGNUM PARTS Valve Cartridges

Part #	Description	1+	4+	8+
1000366-01	MAGNUM DRAIN/NHWBP,ASSY,CART,VALVE-SGL	\$94.55	\$90.98	\$87.41
1000365-01	RINSE VALVE CARTRIDGE	\$151.01	\$145.31	\$139.61
1000317-01	INLET VALVE CARTRIDGE	\$128.81	\$123.95	\$119.09
1000336	UNFILTERED WATER BYPASS CAP	\$11.45	\$11.02	\$10.59

Install Adapters

Miscellaneous Parts

Part #	Description	1+	10+	24+	48+
1000343	CAM COVER	\$15.01	\$12.87	\$12.23	\$11.80
1001751-01	LOGIX MAGNUM CAMSHAFT	\$75.25	\$64.50	\$61.28	\$59.13
1040920	MAGNUM 2"NPT SIDE MOUNT ADAPTR	\$250.62	\$214.82	\$204.08	\$196.92
1041064	BREAK AWAY CAM KIT / AUX OUTPUT, Configurable	\$12.31	\$10.55	\$10.03	\$9.67
1040692	FLAPPER KIT (ALL FLAPPERS AND SPRINGS)	\$54.43	\$46.65	\$44.32	\$42.77

Part #	Description	1+	4+	8+
1000226	SCREEN/CAP ASSEMBLY W/O-RING	\$3.32	\$3.19	\$3.07
1010162	O-RING, TANK ADAPTER TO TANK, -347, EP	\$5.93	\$5.71	\$5.48
1010160	O-RING, -225, EP	\$2.45	\$2.36	\$2.26
1009115	TOP SCREEN FOR MAGNUM Cv	\$76.22	\$73.35	\$70.47
1232965	TURBINE ASSEMBLY, MAGNUM IT - INTERNAL	\$61.58	\$59.26	\$56.93

Softeners / POE



Softeners / POE

STRUCTURAL™ MEDIA TANKS



7" Diameter Poly Glass™ Pressure Vessels

Part #	Description	1±	4±	24±
CH30190-03010203-30	07X35PG2.5" T-BLACK-W/BASE	\$70.16	\$67.51	\$64.87

8" Diameter Poly Glass™ Pressure Vessels

Part #	Description	1±	4±	18±
CH30286-03010203-30	0840PG2.5" T-BLACK-W/BASE	\$58.87	\$56.65	\$54.42
CH30305-03010203-30	0844PG2.5" T-BLACK-W/BASE	\$53.88	\$51.85	\$49.82

9" Diameter Poly Glass™ Pressure Vessels

Part #	Description	1±	4±	16±
CH30383-03010203-30	09X48PG2.5" T-BLACK-W/BASE	\$61.75	\$59.42	\$57.09

10" Diameter Poly Glass™ Pressure Vessels

Part #	Description	1±	4±	12±
CH30460-03010203-30	1035PG2.5" T-BLACK-W/BASE	\$68.12	\$65.55	\$62.98
CH30491-03010203-30	1040PG2.5" T-BLACK-W/BASE	\$82.09	\$78.99	\$75.89
CH30523-03010203-30	1044PG2.5" T-BLACK-W/BASE	\$69.65	\$67.02	\$64.39
CH30546-03010203-30	1047PG2.5" T-BLACK-W/BASE	\$93.35	\$89.83	\$86.31

Part #	Description	1±	4±	16±
CH30579-03010203-30	1054PG2.5" T-BLACK-W/BASE	\$72.13	\$69.41	\$66.68

12" Diameter Poly Glass™ Pressure Vessels

Part #	Description	1±	4±	9±
CH30646-03010203-30	1248PG2.5" T-BLACK-W/BASE	\$98.89	\$95.16	\$91.43
CH30666-03010203-30	1252PG2.5" T-BLACK-W/BASE	\$99.63	\$95.87	\$92.11

13" Diameter Poly Glass™ Pressure Vessels

Part #	Description	1±	4±	9±
CH30721-03010203-30	1354PG2.5" T-BLACK-W/BASE	\$119.10	\$114.60	\$110.11
CH30724-03010203-30	1354PG4" T-BLACK-W/BASE	\$199.66	\$192.12	\$184.59

14" Diameter Poly Glass™ Pressure Vessels

Part #	Description	1±	4±	9±
CH30785-03010203-30	1465PG4" T-BLACK-W/BASE	\$231.00	\$222.28	\$213.57

16" Diameter Poly Glass™ Pressure Vessels

Part #	Description	1±	4±	9±
CH30912-03010203-30	1665 PG4" T-BLACK-W/BASE	\$262.52	\$252.62	\$242.71

18" Diameter Composite Pressure Vessels

Part #	Description	1±	2±	4±
CH30948-01010101-30	1865 COMP 4" T NAT SMC BASE	\$437.12	\$420.63	\$404.13

21" Diameter Composite Pressure Vessels

Part #	Description	1±	2±	4±
CH30953-01010101-30	2162 COMP 4" T NAT SMC BASE	\$507.04	\$487.91	\$468.77

24" Diameter Composite Pressure Vessels

Part #	Description	1±	2±	4±
CH33394	2465 COMP 4" T NAT SMC BASE STD LBL	\$964.30	\$927.91	\$891.52
CH31153-01010101-30	2472 COMP 4" T NAT STD SMC BASE	\$876.00	\$842.95	\$809.89
CH33408	2472 COMP 6" TF 6" BF NAT TRIPOD STD	\$1,742.78	\$1,677.01	\$1,611.25
CH33406	2472 COMP 6" TF NAT SMC BASE	\$1,142.08	\$1,098.98	\$1,055.88

30" Diameter Composite Pressure Vessels

Part #	Description	1±	2±	4±
CH33868	3072 Comp 4" T NAT EXT BASE	\$1,493.30	\$1,436.95	\$1,380.60
CH33414	3072 Comp 6" TF 6" BF NAT TRIPOD BASE	\$1,616.11	\$1,555.12	\$1,494.14
CH33412	3072 Comp 6" TF NAT EXT BASE	\$1,422.70	\$1,369.01	\$1,315.33

36" Diameter Composite Pressure Vessels

Part #	Description	1±	2±	4±
CH34079	3672 COMP 4" T NAT EXT BASE	\$1,713.74	\$1,649.07	\$1,584.40
CH33421	3672 COMP 6" TF NAT EXT BASE	\$1,855.21	\$1,785.20	\$1,715.19
CH33424	3672 COMP 6" TF 6" BF NAT TRIPOD BASE	\$2,141.76	\$2,060.94	\$1,980.12

42" Diameter Composite Pressure Vessels

Part #	Description	1±	2±	4±
CH33427	4272 COMP 6" TF NAT SHORT BASE	\$4,084.77	\$3,930.63	\$3,776.48
CH33429	4272 COMP 6" TF 6" BF NAT TRIPOD BASE	\$3,253.57	\$3,130.80	\$3,008.02

48" Diameter Composite Pressure Vessels

Part #	Description	1±	2±	4±
CH33431	4872 COMP 6" TF NAT SMC BASE	\$3,929.61	\$3,781.32	\$3,633.03
CH33434	4872 COMP 6" TF 6" BF NAT TRIPOD BASE	\$3,980.77	\$3,830.55	\$3,680.33



STRUCTURAL™ BRINE TANKS



Square Brine Tanks

Part #	Description	1+	5+	25+
BT25L-F	1019 SQUARE 25L; BLK W/O FLOAT& TUBING	\$25.23	\$21.63	\$19.83
BT70LH-F	1332 SQUARE 70L; BLACK; C/W BW & FLOAT ASSY	\$51.94	\$44.52	\$40.81
BT100LH-F	1532 SQUARE 100L; BLACK; C/W BW & FLOAT ASSY	\$55.80	\$47.83	\$43.85
BT150LH-F	1736 SQUARE 150L; BLACK; C/W BW & FLOAT ASSY	\$71.24	\$61.06	\$55.97



Square Brine Tanks With Salt Grids

Part #	Description	1+	5+	25+
BT100LH-F-SG	1532 SQUARE 150L; BLACK; C/W BW, FLOAT ASSY & GRID	\$63.22	\$54.19	\$49.68
BT150LH-F-SG	1736 SQUARE 150L; BLACK; C/W BW, FLOAT ASSY & GRID	\$80.14	\$68.69	\$62.97

COMMERCIAL ROUND BRINE TANKS

Part #	Description	1+	2+
BT-200L-Y	20x40 BRINE TANK 200L; ROUND; WHITE		CALL FOR PRICING
BT-300L-Y	23x47 BRINE TANK 300L; ROUND; WHITE		CALL FOR PRICING
BT-800L-Y	34x53 BRINE TANK 800L; ROUND; WHITE		CALL FOR PRICING
BT-500L-Y	29x51 BRINE TANK 500L; ROUND; WHITE		CALL FOR PRICING
BT-2000L-Y	51x63 BRINE TANK 2000L; ROUND; WHITE		CALL FOR PRICING
BT-1000L-Y	39x55 BRINE TANK 800L; ROUND; WHITE		CALL FOR PRICING



2310 safety float assembly (CH15675)

Brine Tanks Components

Part #	Description	1+	5+	25+	
BT100LH-OVERFLOW	OVERFLOW SET; FITTING & NUT	\$1.49	\$1.28	\$1.17	
Part #	Description	1+	5+	15+	
CH15675	BRN TUBE ASSY W/ ELBOW & NUT BRINE TUBE 31.38"	\$26.22	\$25.23	\$24.24	
CH15676	BRN TUBE ASSY 1840 W/ ELBOW & NUT BRINE TUBE	\$34.14	\$32.85	\$31.57	
CH16359	14" X 34" GRID PLATE 1-PC 4.25" HOLE	\$18.37	\$17.68	\$16.99	
CH16347	18" GRID PLATE WITH 4-1/8" HOLE; BT1840 & BT1833	\$10.55	\$10.15	\$9.75	
Part #	Description	1+	10+	25+	50+
09004361	BRINE PICK-UP TUBE ASSY 36"	\$7.66	\$6.76	\$6.31	\$5.86
Part #	Description	1+	5+	15+	30+
36532810	3.5"X28" SLOTTED BRINE WELL; NO CAP	\$5.82	\$5.13	\$4.79	\$4.45
36543601	4" X 36" SLOTTED BRINE WELL; NO CAP	\$8.11	\$7.16	\$6.68	\$6.21
36544801	4" X 48" SLOTTED BRINE WELL; NO CAP	\$12.04	\$10.10	\$9.61	\$8.91
36554801	5" X 48" SLOTTED BRINE WELL; NO CAP	\$58.52	\$51.64	\$48.20	\$44.76
36540000	BRINE WELL CAP 4.0"	\$0.82	\$0.72	\$0.67	\$0.63
36550000	BRINE WELL CAP 5"	\$2.48	\$2.19	\$2.05	\$1.90
H6001	BRINE VALVE .75" MPT TYPE A SET BRINE CHECK	\$144.54	\$137.03	\$123.89	\$120.14
H7073	BRINE VALVE 1.0" MPT TYPE A SET BRINE CHECK	\$255.07	\$241.82	\$218.63	\$212.00
Part #	Description	1+	4+	8+	
60067-03	2310 PLASTIC B/V & 2310 FLOAT ASSY COMBO	\$15.84	\$15.24	\$14.65	
60002-34	#500 AIR CHECK; 34" LONG	\$5.14	\$4.94	\$4.75	
60009-00	900 AIR CHECK WITH TUBE	\$34.96	\$33.64	\$32.33	
Part #	Description	1+	10+	24+	48+
H7070-484-54	484; FLOW CONTROL; 54" FLOAT ROD	\$77.53	\$66.45	\$63.13	\$60.92
Part #	Description	1+	4+	20+	40+
H1080	24" GRID PLATE (2 PIECE)	\$63.47	\$58.41	\$54.12	\$49.84
H1089	PLASTIC BRINE GRIDS 24"-LEGS 9-7/8" (7 SET)	\$15.29	\$13.10	\$12.45	\$12.01
H1032	30 BRINE GRID" (2 PIECE)	\$119.37	\$102.32	\$97.20	\$93.79
H1087-13"	LEGS ONLY; 30" SALT GRID; 1.5" X 13"; 11 PER SET	\$28.42	\$26.15	\$24.24	\$22.32

#CH15675 & #CH15676 include:

- Brinewell
- Safety float assemble
- Brineline
- Overflow nut & elbow

NEOPRENE TANK JACKETS



Neoprene Tank Jackets with Zipper

Part #	Description	1+	4+	16+	40+
YY-WS-J948	9X48 NEOPRENE TANK JACKET WITH ZIPPER, BLACK	\$30.32	\$25.42	\$24.19	\$22.44
YY-WS-J1054	10X54 NEOPRENE TANK JACKET WITH ZIPPER, BLACK	\$36.35	\$30.47	\$29.00	\$26.90
YY-WS-J1252	12X52 NEOPRENE TANK JACKET WITH ZIPPER, BLACK	\$41.79	\$35.03	\$33.34	\$30.92



RISERS, BASKETS, HUB AND LATERALS



Upper Basket
(05008102)

Upper Baskets and Diffusers

Part #	Description	1+	4+	8+	
18280	COLLECTOR, TOP, 1" X 0.11, GRAY BAYONET- FLECK ONLY	\$2.06	\$1.98	\$1.91	
Part #	Description	1+	10+	24+	48+
D1203	UPPER BASKET; 1.05"; TWIST LOCK; AUTOTROL/CLACK	\$1.99	\$1.83	\$1.70	\$1.57
05008102	UPPER BASKET TWIST-LOCK 1.05" - AUTOTROL/CLACK	\$2.03	\$1.79	\$1.67	\$1.56
Part #	Description	1+	2+	4+	
CH5679	6" FLANGE TOP DIFFUSER; 3" FNPT; 18"-48" TANK	\$202.88	\$195.22	\$187.57	
Part #	Description	1+	4+	8+	
CH5680-2	6" FLANGE HIGH FLOW TOP DIFFUSER; 3" FNPT; 21"-63" TANK	\$567.02	\$545.62	\$524.23	



930 Bottom Distributor
(D1212-04)

Lower Basket (no pipe)

Part #	Description	1+	10+	24+	48+
D1212-04	930 BOTTOM STACK DIST; 11 SEGMENT; 1.05"	\$6.87	\$6.33	\$5.86	\$5.40
Part #	Description	1+	24+	48+	96+
D1212-21	930 BOTTOM STACK DIST; 15 SEGMENT; 1.320"	\$8.37	\$7.17	\$6.81	\$6.57
D1197-07	970 BOTTOM DISTRIBUTOR 1.5" SOLVENT	\$49.07	\$45.63	\$43.44	\$40.00
05008199	UNIVERSAL LOWER BASKET; 1" AND 1 3/16"	\$3.25	\$2.73	\$2.59	\$2.41
Part #	Description	1+	5+	25+	
N182C-1.5	BOTTOM STACK DISTRIBUTOR; 1.5"	\$10.39	\$8.91	\$8.17	



Lower Basket
(05008199)

Risers with Basket

Part #	Description	1+	5+	25+
X2811+55"	RIS BASKET & 55". RISER TUBE ASSY; 1.05" (YELLOW)	\$6.68	\$5.73	\$5.25
X2811+72"	RIS BASKET & 72". RISER TUBE ASSY; 1.05" (YELLOW)	\$7.80	\$6.68	\$6.13



Riser with Lower Basket

Riser Pipe (no basket)

Part #	Description	1+	5+	25+	50+
0500131686	1 3/16" PIPE 72"	\$7.39	\$6.52	\$6.09	\$5.65
0500340086	RISER TUBE 1.05 X 72" ABS 3/4" PIPE GRAY	\$7.19	\$6.35	\$5.93	\$5.50



Tank Reducer

Hot Water Riser

Part #	Description	1+	4+	8+
60795-10	DISTRIBUTOR ASSY, 1" STD, HOT WATER 72"	\$26.13	\$25.14	\$24.16

Tank Closures and Bushings

Part #	Description	1+	3+	6+
N9915	6" FLANGED TANK CLOSURE	\$26.72	\$22.90	\$20.99
Part #	Description	1+	5+	25+
N9905	ADA KIT 6" FLG NORYL 4"-8 UN BOLTS	\$26.72	\$22.90	\$20.99
N9903-A	4" X 2.5" TANK REDUCER-STRUCTURL	\$5.35	\$4.58	\$4.20

Top Mount Hub And Lateral - 1.5" Riser Tube, 6 Laterals (Requires 4" Tank Opening)



Top Mount Hub
and Lateral

Part #	Description	1+	5+	25+
ES6260B2	TOP MOUNT HUB & LATERAL; 1.5"; 13"-16" TANK	\$18.45	\$14.76	\$13.53
ES6370B2	TOP MOUNT HUB & LATERAL; 1.5"; 18"-21" TANK	\$20.19	\$17.30	\$15.86
ES6450B2	TOP MOUNT HUB & LATERAL; 1.5"; 24" TANK	\$25.23	\$21.63	\$19.83
ES6600B2	TOP MOUNT HUB & LATERAL; 1.5"; 30" TANK	\$34.14	\$29.26	\$26.82
ES6700B2	TOP MOUNT HUB & LATERAL; 1.5"; 36" TANK	\$39.18	\$33.59	\$30.79

Top Mount Hub And Lateral - 3" Riser Tube, 8-16 Laterals (Requires 6" Flange Tank Opening)



Funnel

Part #	Description	1+	2+	4+	8+
5672	TOP MOUNT HUB & LATERAL; 3"; 30" 8 LATERALS	\$380.25	\$325.93	\$309.63	\$298.77
5673	TOP MOUNT HUB & LATERAL; 3"; 36" 8 LATERALS	\$404.08	\$346.35	\$329.04	\$317.49
5674	TOP MOUNT HUB & LATERAL; 3"; 42" 8 LATERALS	\$417.27	\$357.66	\$339.78	\$327.85
5675	TOP MOUNT HUB & LATERAL; 3"; 48" 8 LATERALS	\$393.92	\$337.64	\$320.76	\$309.51

Miscellaneous

Part #	Description	1+	5+	25+
N32	FUNNEL, 2.5" NECK OPENING	\$5.94	\$5.09	\$4.67
N50	FUNNEL FOR 4" & 6" TANK OPENINGS	\$7.42	\$6.36	\$5.83



MEDIA & RESIN



Water Softener Resin

Part #	Description	1+	10+	42+	
TC008FG	CATION RESIN; 8% XLINK; 1 CUBIC FOOT	\$50.00	\$45.00	\$40.00	
TC008FGF	CATION RESIN; FINE MESH 8% XLINK; 1 CUBIC FOOT	\$59.00	\$53.10	\$47.20	
TC010FG	CATION RESIN; 10% XLINK; 1 CUBIC FOOT	\$60.50	\$54.45	\$48.40	
Part #	Description	1+	10+	25+	42+
C-C150E	PUROLITE HOT WATER; SAC MACROPOROUS; NA FORM	\$235.62	\$201.96	\$191.86	\$185.13
C-SSTC6000E	PUROLITE SSTC60 RESIN; 1 CUBIC FOOT	\$205.81	\$176.41	\$167.59	\$161.71



PUROLITE (C-C150E)

Organic Scavaging Resin

Part #	Description	1+	10+	42+	
TA213	STRONG BASE ANION GEL (COLOUR REMOVER) RESIN	\$209.00	\$188.10	\$167.20	
Part #	Description	1+	10+	25+	42+
C-A850	ANION COLOR RESIN; REMOVE TANNIN; 1.0 CU. FT. BOX	\$391.25	\$335.36	\$318.59	\$307.42
C-A860	ANION RESIN 1 CUBIC FOOT; REMOVE TANNIN-BOXED	\$421.82	\$361.56	\$343.48	\$331.43
C-TANEX	PUROLITE TAN-EX RES (MACROPROE-OPAQUE)	#####	\$917.69	\$871.81	\$841.22



Mixed Bed DI Resin

Part #	Description	1+	10+	42+
TY MB-1	MIXED BED DI RESIN 1 CUFT BAG	\$144.00	\$129.60	\$103.68
TYMB-P	MIXED BED DI RESIN, ULTRA LOW TOC 1 CUFT BAG	\$178.00	\$160.20	\$128.16

Carbon

Part #	Description	1+	10+	40+	
RWAP 3211	HAYCARB 12X40 COCO CARBON; 1CUFT	\$78.81	\$70.93	\$63.05	
RWAC 1802	HAYCARB 12X40 CATALYTIC COCO CARBON; 1CUFT	\$157.70	\$141.93	\$126.16	
Part #	Description	1+	10+	40+	80+
CBCGCENTAUR1CF	CENTAUR CATALYTIC CARBON 12x40; 1 CUFT	\$206.79	\$193.95	\$185.39	\$176.84

Filter Media

Part #	Description	1+	4+	16+	40+
NEXSAND	FILTER MEDIA; 1 CUBIC FOOT; 53 LBS	\$30.26	\$26.94	\$25.37	\$24.14
A8006	BIRM; 44 LBS; FINE; 1 CUBIC FOOT	\$68.17	\$64.63	\$61.09	\$56.66
KATALOX-LIGHT	MEDIA OXIDATION MANG/SULPHUR RED. 1 CUFT	\$144.71	\$135.06	\$125.42	\$118.18
A8014	FILTER AG; 1 CUBIC FOOT; 25 LBS	\$28.94	\$27.44	\$25.93	\$24.05
RTG1AL0000-PRODCF	METSORB; 1CUBIC FOOT	\$952.90	\$816.78	\$775.94	\$748.71
KDF-55	KDF-55 DRUM; 1/3 CUBIC FOOT; 57 LBS	\$836.45	\$780.69	\$724.92	\$691.46
KDF-55-COURSE	KDF-55-COURSE; 1/3 CUBIC FOOT; 57 LBS	\$838.33	\$782.44	\$726.56	\$693.02
KDF-85	KDF-85 DRUM; 1/3 CUBIC FOOT; 57LBS	#####	\$976.29	\$906.56	\$864.72



BIRM (A8006)



(KATALOX-LIGHT)

Part #	Description	1+	4+	16+
A8011	COROSEX; 50 LBS; 0.66 CUBIC FOOT	\$145.27	\$135.58	\$125.90
A8036	GARNET MEDIA 8/12 50LBS	\$40.73	\$38.61	\$36.49
A8037	GARNET MEDIA 30/40 50LBS	\$40.74	\$38.63	\$36.51

Part #	Description	1+	4+	16+	60+
PURI-CAL	CALCIUM CARBONATE; 45 LBS 0.5 CU/FT	\$35.08	\$33.11	\$31.14	\$30.35

Part #	Description	1+	10+	40+
50-8X20	PYROLOX; 8 X 20 MESH; 0.5 CU FT; 60 LBS	\$116.24	\$111.40	\$103.33

Part #	Description	1+	4+	10+
GRIT2-50	GRIT #3 50LBS 1/4X1/8 0.5CU/FT	\$21.04	\$19.99	\$19.29

Part #	Description	1+	10+	55+	110+
GREENSAND-PLUS	GREENSAND-PLUS 0.50 CUBIC FOOT (42.5LBS)	\$83.18	\$71.30	\$67.74	\$65.36



Softeners / POE

METSORB BY GRAVER TECHNOLOGIES



Graver Technologies

MetSorb® HMRG

Effective, Low-Cost Adsorbent for Removal of Heavy Metals



- Arsenic III
- Arsenic V
- Cadmium
- Copper
- Antimony
- Lead
- Mercury
- Zinc
- Selenium



Certified to
NSF / ANSI 61

BATCH TEST DATA • ADSORPTIVE CAPACITY METSORB® HMRG		
METAL	INITIAL CONCENTRATION	FINAL CONCENTRATION
Arsenic V	50 ppb	< 2 ppb
Arsenic III	50 ppb	5 ppb
Cadium	1,000 ppb	24 ppb
Copper	500 ppb	5 ppb
Lead	1,000 ppb	18 ppb
Mercury	500 ppb	26 ppb
Zinc	500 ppb	12 ppb

Metsorb

Part #	Description	1+	4+	16+	40+
RTG1AL0000-PRODCF	METSORB HMRG; 1CUFT	\$744.90	\$638.48	\$606.56	\$585.28

SOFTENER TUBING



Drain Line Tubing

Part #	Description	1+	4+	16+	40+
5912003	1/2"OD X 3/8"ID DRAIN TUBE BLACK 100'	\$46.31	\$38.81	\$36.94	\$34.26
360-10X100	POLY 5/8"OD X 1/2"ID 100FT NATURAL; FOOD GRADE	\$50.43	\$45.84	\$44.01	\$42.18
Part #	Description	1+	5+	10+	
2T20-1008BK-100	1/2" ID X 5/8"OD FDA PE TUBING;BLACK	\$34.92	\$32.59	\$30.27	

Brine Line Tubing

Part #	Description	1+	100+	500+	
TUB6BKP60	3/8 PE TUBING; 60"; BLACK	\$1.67	\$1.56	\$1.45	
Part #	Description	1+	3+	6+	12+
TUB8BK-10FT	1/2" O.D. POLY TUBING 10'	\$4.23	\$3.61	\$3.28	\$3.11
Part #	Description	1+	4+	10+	20+
PE12-EI-0500F-E	3/8" JG PE TUBING-BLACK-500 FT	\$140.50	\$116.59	\$104.63	\$98.65
PE16-GI-0250F-E	1/2" JG PE TUBING-BLACK-250FT	\$100.88	\$83.71	\$75.12	\$70.83

CHEMICALS - EQUIPMENT CLEANERS



Feeders

Part #	Description	1+	5+	10+	25+
S6304	RESCARE FEEDER; YELLOW; 0.40 oz 12cc	\$13.78	\$12.26	\$11.55	\$10.99
S6305	RESCARE FEEDER; CLEAR; 1.0 oz 30cc	\$13.36	\$11.90	\$11.20	\$10.66

Pro ResCare® Liquid Resin Cleaner Maintains Performance of Softener Resin. Pro ResCare is a specially formulated liquid resin cleaner designed to clean resin pores of iron, manganese, silt, metal particles and organic compounds that cause softener inefficiencies. Regular use of ResCare resin cleaner will restore the softener beads and control valve parts back to peak efficiency. For best results, use a Res Care Automatic Feeder or manually add during regeneration to prevent mineral build up. Pro Res Care is NSF Certified to meet NSF/ANSI Standard 60 for drinking water additives.



Pro ResCare
1GAL. & 1QT.

Chemicals - Equipment Cleaners

Part #	Description	1+	4+	20+
F-RK41N	PRO RES CARE CLEANER; 1 GALLON	\$15.77	\$14.65	\$13.52
Part #	Description	1+	12+	60+
RK32N	PRO RES CARE CLEANER; 1QUART	\$5.70	\$5.29	\$4.88



Pro Rust Out
5LBS & 1.5LBS

Pro Rust Out® - Water Softener Rust Remover Maintains Performance of Softeners on Iron Bearing Water. Pro Rust Out chemically removes iron and rust build-up that coats the resin beds and fouls the softener. This iron build-up is not totally removed during normal regeneration of a water softener. Using Pro Rust Out in a water softener will eliminate rust and foreign matter from the resin bed. This increases the life of the softener and reduces rust staining on household fixtures and other surfaces.

Part #	Description	1+	6+	30+
LI0616N	PRO RUST OUT INSTANT LIQUID; 16 OZ BOTTLE	\$5.20	\$4.83	\$4.46
RO12N	PRO RUST OUT; 22 OZ	\$6.99	\$6.50	\$6.00
RO65N	PRO RUST OUT; 76 OZ	\$19.05	\$17.69	\$16.33



Softener Mate

Pro Softener Mate® - All Purpose Water Softener Cleaner Maintains Performance of All Softeners. Pro Softener Mate softener cleaner is a unique blend of chemicals formulated to remove limited iron, manganese, silt, metal particles and organic compounds that cause softener inefficiencies. Regular use of Softener Mate softener cleaner as a maintenance program will restore the softener back to peak efficiency and maintain the life of the unit.

Part #	Description	1+	2+	5+
SM100S	SOFTENER MATE; 4 OZ; 100 PACKETS	\$219.64	\$203.95	\$188.26
SM65N	PRO SOFTENER MATE; 4 LBS	\$22.64	\$21.02	\$19.40



Ban-T®

Ban-T® - Water Softener Iron Removal Alkaline Water Neutralizer & Cleaner. Maintains the pH of alkaline water. Pro Ban T is a water softener iron removal cleaner that is specially formulated to effectively lower pH and remove iron and other contaminants from fouled water softeners.

Part #	Description	1+	12+	60+
RU15N	PRO BAN T (CITRIC ACID); 1.5 LBS BOTTLE	\$11.75	\$10.91	\$10.07
RU64N	PRO BAN T (CITRIC ACID); 4 LBS BOTTLE	\$26.72	\$24.81	\$22.90
RU45N	PRO BAN T (CITRIC ACID); 45 LBS	\$251.54	\$233.58	\$215.61



Poly-Guard Phosphate
(GL41N)

Poly Guard® - Prevent Hard Water Stains Rust & Scale Preventer. Pro PolyGuard Scale & Rust Preventer (Liquid) is specifically formulated to prevent hard water stains, including scale and iron staining in commercial, industrial and residential potable water applications. PolyGuard forms a protective coating on metal and plastic surfaces preventing hard water stains, scale, corrosion and copper leaching. To eliminate hard water stains, inject PolyGuard by chemical feed pump into the raw water system as close to the source as possible. This product is NSF Certified to meet NSF/ANSI Standard 60 for drinking water additives.

Scale, Iron & Corrosion Control

Part #	Description	1+	4+	20+
GL41N	POLY-GUARD LIQUID 1.0 GAL	\$51.39	\$47.72	\$44.05
GL05N	POLY-GUARD LIQUID 5.0 GAL BLENDED PHOSPHATE	\$212.96	\$197.75	\$182.54
GP10C	POLY-GUARD CRYSTAL CART. STD; COMES FULL	\$43.29	\$40.19	\$37.10
GP63N	POLY-GUARD CRYSTALS; 3LBS; IRON, SCALE, RUST	\$64.93	\$60.29	\$55.65



Cartridge for Poly
Crystals
(GP10C)



Poly-Guard
Crystals
3LBS
(GP63N)



Softeners / POE

Sani-System - Sani-System Liquid Sanitizer Concentrate is the only EPA registered & NSF approved sanitizer for use in water softeners and reverse osmosis units. It's proven to kill 99.99% of harmful bacteria without using chlorine, oxidizers or acids that can harm system equipment, parts and resin. Each packet of concentrated formula sanitizes equipment in just 60 seconds and is available in exact pre-measured doses for both water softeners and RO units.



Sani-System

Sanitizers & Disinfectants

Part #	Description	1+	2+	5+
SS24WS	SOFTENER SANI SYSTEM; 0.5 FL OZ (CASE OF 24)	\$80.14	\$74.42	\$68.69
SS96WS	SOFTENER SANI SYSTEM; 0.5 FL OZ (CASE OF 96)	\$250.80	\$232.89	\$214.97
SS96RO	RO SANI SYSTEM; 0.25 FL OZ (CASE OF 96)	\$250.80	\$232.89	\$214.97

Neutra Sul® - Eliminate Rotten Egg Smell Professional Grade Oxidizer Protects Against Irregular Coloring and Rotten Egg Smells in Treated Water. Pro Neutra Sul® is formulated to remove the rotten egg smell and pollutants from any water supply through oxidation. Neutra Sul is a blend of Hydrogen Peroxide 7% solution and will prevent the formation of colors, tastes, corrosion and scaling by pollution degradation. Pro Neutra Sul is NSF Certified to meet NSF/ANSI Standard 60 for drinking water additives.



Neutra Sul®

Problem Water Neutralizers

Part #	Description	1+	4+	20+
HP41N	PRO NEUTRA SUL (7% PEROXIDE) 4-1GAL. BT	\$8.17	\$7.58	\$7.00
HP22N	NEUTRA SUL 7% PEROXIDE SOLUTION; 2.5 GALLON	\$19.67	\$18.26	\$16.86
F-HP05N	NEUTRA SUL 7% PEROXIDE SOLUTION; 5 GALLON	\$40.81	\$37.90	\$34.98
SP40N	NEUTRA 7 SODA ASH W/ PHOSPHATE; 40 LB PAIL	\$129.11	\$119.89	\$110.67
SP47N	NEUTRA-7 SODA ASH W/ PHOSPHATE, 7LB BOTTLE	\$26.90	\$24.98	\$23.06



Neutra 7 (SP47N)

Rid O'Rust Formula Is most effective at preventing rust stains for well water with hardness greater than 15 GPG. For irrigation applications only.



Rid-O-Rust

Irrigation Chemicals

Part #	Description	1+	4+	20+
2662	RID-O-RUST LIQUID STAIN REMOVER; 1GAL	\$10.39	\$9.65	\$8.91
RR1-1-CS	RID-O-RUST FORMULA PREVENTER; 64OZ	\$20.78	\$19.30	\$17.81

MAZZEI® INJECTOR COMPANY - INJECTORS



Mazzei Injectors

Part #	Description	1+	5+	10+
384	1/2" MNPT ; PVDF	\$57.02	\$53.22	\$49.42
484	1/2" MNPT ; PVDF	\$57.02	\$53.22	\$49.42
484A	3/4" MNPT ; PVDF	\$57.02	\$53.22	\$49.42
584	3/4" MNPT ; PVDF	\$57.02	\$53.22	\$49.42
684	3/4" MNPT ; PVDF	\$57.02	\$53.22	\$49.42
878	1" MNPT ; PVDF	\$111.57	\$104.13	\$96.69
978	1" MNPT ; PVDF	\$111.57	\$104.13	\$96.69
1078	1" MNPT ; PVDF	\$111.57	\$104.13	\$96.69
1583A	1.5" MNPT ; PVDF	\$159.74	\$149.10	\$138.45
1584A-PVDF	1.5" MNPT ; PVDF	\$159.74	\$149.10	\$138.45



RUSCO™ FILTERS



Screen Sizes (Polyester)		
Mesh	Microns	Opening
30	533	.021"
60	254	.010"
100	152	.006"
140	104	.004"

Also Available In
Stainless Steel

3/4" Spin-Down Polyester Filters with Flush Valves

Part #	Description	1±	5±	10±
3/4-24-F	24 MESH	\$54.06	\$50.45	\$46.85
3/4-30-F	30 MESH	\$54.06	\$50.45	\$46.85
3/4-40-F	40 MESH	\$55.69	\$51.97	\$48.26
3/4-60-F	60 MESH	\$56.35	\$52.59	\$48.83
3/4-100-F	100 MESH	\$59.15	\$55.21	\$51.27
3/4-140-F	140 MESH	\$56.35	\$52.59	\$48.83
3/4-250-F	250 MESH	\$58.39	\$54.50	\$50.61
3/4-500-F	500 MESH	\$56.67	\$52.89	\$49.12
3/4-1000-F	1000 MESH	\$56.67	\$52.89	\$49.12

1" Spin-Down Polyester Filters with Flush Valves

Part #	Description	1±	5±	10±
1-24-F	24 MESH	\$54.06	\$50.45	\$46.85
1-30-F	30 MESH	\$55.69	\$51.97	\$48.26
1-40-F	40 MESH	\$54.06	\$50.45	\$46.85
1-60-F	60 MESH	\$59.15	\$55.21	\$51.27
1-100-F	100 MESH	\$54.70	\$51.05	\$47.41
1-140-F	140 MESH	\$59.15	\$55.21	\$51.27
1-250-F	250 MESH	\$56.67	\$52.89	\$49.12
1-500-F	500 MESH	\$58.39	\$54.50	\$50.61
1-1000-F	1000 MESH	\$58.39	\$54.50	\$50.61

1 1/2" Spin-Down Polyester Filters with Flush Valves

Part #	Description	1±	5±	10±
1-1/2-24-F	24 MESH	\$71.62	\$66.84	\$62.07
1-1/2-30-F	30 MESH	\$71.62	\$66.84	\$62.07
1-1/2-40-F	40 MESH	\$71.66	\$66.88	\$62.10
1-1/2-60-F	60 MESH	\$80.40	\$75.04	\$69.68
1-1/2-100-F	100 MESH	\$76.57	\$71.47	\$66.36
1-1/2-140-F	140 MESH	\$74.32	\$69.37	\$64.41
1-1/2-250-F	250 MESH	\$79.27	\$73.98	\$68.70
1-1/2-500-F	500 MESH	\$83.22	\$77.67	\$72.12

2" Spin-Down Polyester Filters with Flush Valves

Part #	Description	1±	5±	10±
2-24-F	24 MESH	\$120.08	\$112.08	\$104.07
2-30-F	30 MESH	\$120.05	\$112.05	\$104.04
2-40-F	40 MESH	\$116.56	\$108.79	\$101.02
2-60-F	60 MESH	\$119.57	\$111.59	\$103.62
2-100-F	100 MESH	\$129.32	\$120.70	\$112.08
2-140-F	140 MESH	\$129.32	\$120.70	\$112.08
2-250-F	250 MESH	\$132.52	\$123.68	\$114.85
2-500-F	500 MESH	\$133.57	\$124.67	\$115.76
2-1000-F	1000 MESH	\$127.21	\$118.73	\$110.25

3/4" Sediment Trapper Polyester Filters with Flush Valve

Part #	Description	1±	5±	10±
3/4-100ST-F	100 MESH	\$77.09	\$71.95	\$66.81
3/4-1000ST-F	1000 MESH	\$73.89	\$68.97	\$64.04

1" Sediment Trapper Polyester Filters with Flush Valve

Part #	Description	1±	5±	10±
1-250ST-F	250 MESH	\$73.89	\$68.97	\$64.04
1-500ST-F	500 MESH	\$73.89	\$68.97	\$64.04
1-1000ST-F	1000 MESH	\$73.89	\$68.97	\$64.04

1 1/2" Sediment Trapper Polyester Filters with Flush Valve

Part #	Description	1±	5±	10±
1-1/2-100ST-F	100 MESH	\$89.26	\$83.31	\$77.36
1-1/2-250ST-F	250 MESH	\$92.69	\$86.51	\$80.34

2" Sediment Trapper Polyester Filters with Flush Valve

Part #	Description	1±	5±	10±
2-40ST-F	40 MESH	\$144.81	\$135.15	\$125.50
2-60ST-F	60 MESH	\$147.33	\$137.51	\$127.69
2-100-ST-F	100 MESH	\$120.38	\$112.36	\$104.33
2-1000ST-F	1000 MESH	\$139.58	\$130.27	\$120.97



Softeners / POE



3/4" Sediment Trapper

Polyester Chemical Resistant Filters with Flush Valve

Part #	Description	1±	5±	10±
3/4-24ST-HP-F	24 MESH	\$92.30	\$86.15	\$80.00
3/4-30ST-HP-F	30 MESH	\$92.30	\$86.15	\$80.00
3/4-60ST-HP-F	60 MESH	\$93.34	\$87.12	\$80.89
3/4-100ST-HP-F	100 MESH	\$93.34	\$87.12	\$80.89
3/4-140ST-HP-F	140 MESH	\$96.14	\$89.73	\$83.32
3/4-250ST-HP-F	250 MESH	\$95.31	\$88.96	\$82.60

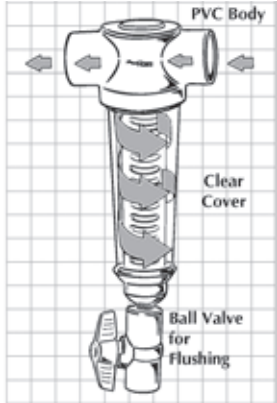

Spin Down Filter

1" Sediment Trapper

Polyester Chemical Resistant Filter with Flush Valve

Part #	Description	1±	5±	10±
1-100ST-HP-F	100 MESH	\$100.95	\$94.22	\$87.49

2" Sediment Trapper Stainless Steel Filters with Flush Valve

Part #	Description	1±	5±	10±
2-30STSS-F	30 MESH SS	\$148.63	\$138.72	\$128.81
2-60STSS-F	60 MESH SS	\$152.96	\$142.77	\$132.57
2-200STSS-F	200 MESH SS	\$159.24	\$148.62	\$138.00

3/4" Spin-Down Polyester Filter Screens

Part #	Description	1±	5±	10±
FS3/4-140	140 MESH	\$13.36	\$12.47	\$11.58
FS3/4-250	250 MESH	\$15.07	\$14.07	\$13.06
FS3/4-500	500 MESH	\$15.08	\$14.07	\$13.07
FS3/4-1000	1000 MESH	\$15.08	\$14.07	\$13.07

1" Spin-Down Polyester Filter Screens

Part #	Description	1±	5±	10±
FS1-40	40 MESH	\$13.32	\$12.43	\$11.55
FS1-60	60 MESH	\$13.36	\$12.47	\$11.58
FS1-100	100 MESH	\$13.98	\$13.05	\$12.12
FS1-140	140 MESH	\$13.98	\$13.05	\$12.12
FS1-250	250 MESH	\$15.08	\$14.07	\$13.07
FS1-500	500 MESH	\$15.83	\$14.77	\$13.72
FS1-1000	1000 MESH	\$15.08	\$14.07	\$13.07

1 1/2" Spin-Down Polyester Filter Screens

Part #	Description	1±	5±	10±
FS1 1/2-40	40 MESH	\$21.47	\$20.04	\$18.61
FS1 1/2-60	60 MESH	\$24.00	\$22.40	\$20.80
FS1 1/2-100	100 MESH	\$23.43	\$21.86	\$20.30
FS1 1/2-140	140 MESH	\$23.40	\$21.84	\$20.28
FS1 1/2-250	250 MESH	\$27.43	\$25.60	\$23.78
FS1 1/2-500	500 MESH	\$26.11	\$24.37	\$22.63
FS1 1/2-1000	1000 MESH	\$26.14	\$24.39	\$22.65

2" Spin-Down Polyester Filter Screens

Part #	Description	1±	5±	10±
FS2-60	60 MESH	\$38.70	\$36.12	\$33.54
FS2-100	100 MESH	\$38.64	\$36.07	\$33.49
FS2-140	140 MESH	\$38.70	\$36.12	\$33.54
FS2-250	250 MESH	\$42.68	\$39.84	\$36.99
FS2-500	500 MESH	\$42.76	\$39.91	\$37.06
FS2-1000	1000 MESH	\$42.76	\$39.91	\$37.06

Stainless Steel Filter Screens

Part #	Description	1±	5±	10±
FS3/4-60SS	3/4" 60 MESH; SPIN DOWN	\$20.48	\$19.12	\$17.75
FS1-60SS	1" 60 MESH; SPIN DOWN	\$20.48	\$19.12	\$17.75
FS1-200SS	1" 200 MESH; SPIN DOWN	\$22.72	\$21.20	\$19.69
FS1 1/2-140SS	1 1/2" 140 MESH; SPIN DOWN	\$34.05	\$31.78	\$29.51
FS2-60SS	2" 60 MESH; SPIN DOWN	\$49.33	\$46.05	\$42.76

Sediment Trapper Polyester Filter Screens

Part #	Description	1±	5±	10±
FS1-500ST	1" 500 MESH	\$16.75	\$15.63	\$14.52
FS2-60ST	2" 60 MESH	\$53.29	\$49.73	\$46.18

Auto Flush Valve

Part #	Description	1±	5±	10±
AFV	AUTO FLUSH VALVE	\$443.86	\$414.27	\$384.68
AFV-KIT	AUTO FLUSH VALVE INSTALL KIT	\$27.44	\$25.61	\$23.78

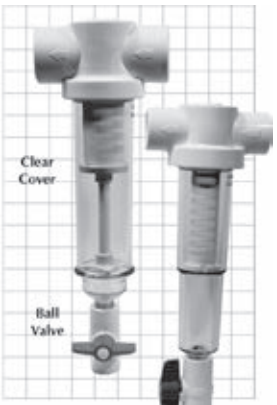

Sediment Trapper

CALL FOR ITEMS NOT LISTED

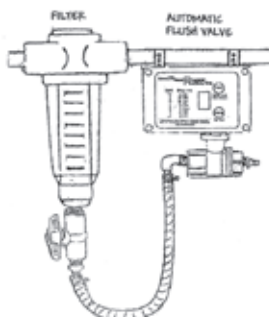

Auto Flush Valve
Install Diagram



Good Water Warehouse, Inc.

CANADASALES@GOODWATERWAREHOUSE.COM
GOODWATERWAREHOUSE.COM

PRICES ARE USD FOB
CALGARY/NEWMARKET

ALBERTA

TEL: (403) 252-7972
TEL: (888) 668-1234
FAX: (888) 227-3291

ONTARIO

TEL: (905) 868-9287
TEL: (888) 868-9287
FAX: (905) 830-0512

NOTES

Softeners / POE



DRINKING WATER SYSTEMS

RO Systems

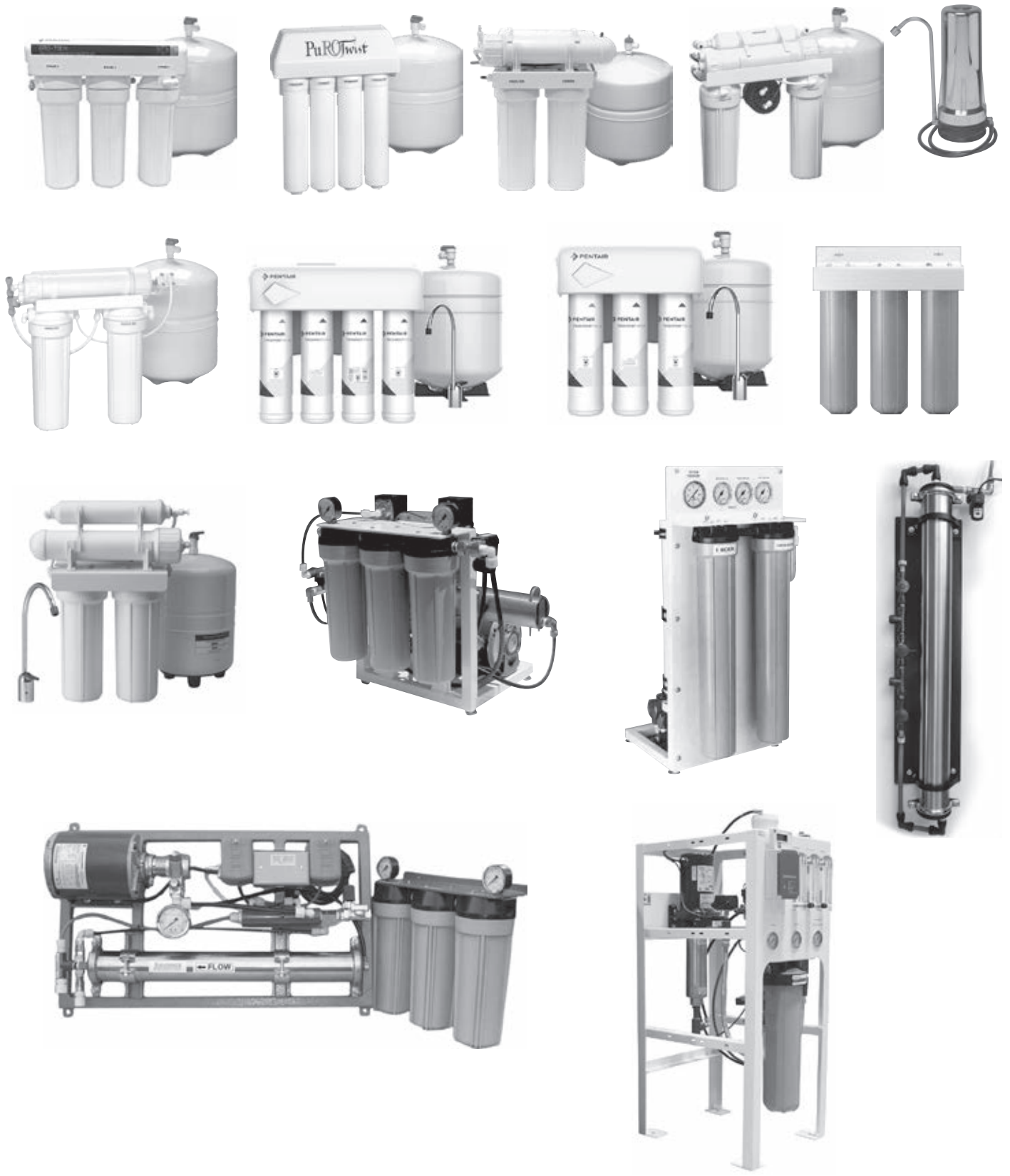



FRESHPOINT UNDER COUNTER REVERSE OSMOSIS SYSTEM



FRESHPOINT REVERSE OSMOSIS SYSTEMS



System Tested and Certified by NSF International against NSF/ANSI Standard 42, 53, 58, and CSA B483.1 for the reduction for the claims specified on the Performance Data Sheet.



50 GPD
FreshPoint 3 Stage
(C-161110)



75 GPD
FreshPoint 4 Stage
(C-161111)



75 GPD
FreshPoint 5 Stage
(C-161112)

FreshPoint RO Features:

- High efficiency GRO 75 GPD membrane technology (GRO-475BP only)
- Effortless click-in lock cartridge installation
- 3/8" push fit plumbing connection for easy installation and high flow
- Color coded cartridges to maintain proper filter sequence
- Lead and chemical reduction cartridge
- Faucet with air gap included
- 3/8" tubing to storage tank and faucet

FreshPoint 3-Stage

Part #	Description	1+	4+	8+
C-161110	GRO-350B RO 3-STAGE; 50 GPD	\$225.00	\$206.25	\$187.50

FreshPoint 3-Stage Replacement Cartridges

Part #	Description	1+	12+	24+
C-655121-96	GRO50-RC 50 GPD GRO MEMBRANE CARTRIDGE	\$60.14	\$55.13	\$50.11
C-655123-96	FDF1-RC, CARTRIDGE, SED/CARBON CTO	\$21.54	\$19.75	\$17.95
C-655117-96	F1GC-RC POST FILTER CARTRIDGE	\$17.66	\$16.19	\$14.72

FreshPoint 4-Stage

Part #	Description	1+	4+	8+
C-161111	GRO-475B RO 4-STAGE; 75 GPD	\$300.00	\$275.00	\$250.00

FreshPoint 4-Stage Replacement Cartridges

Part #	Description	1+	12+	24+
C-655123-96	FDF1-RC, CARTRIDGE, SED/CARBON CTO	\$21.54	\$19.75	\$17.95
C-655122-96	GRO75-RC 75 GPD GRO MEMBRANE CARTRIDGE	\$64.51	\$59.14	\$53.76
C-655120-96	F1B1-RC LEAD/CHEMICAL CARBON BLK CART.	\$25.15	\$23.06	\$20.96
C-655117-96	F1GC-RC POST FILTER CARTRIDGE	\$17.66	\$16.19	\$14.72

FreshPoint 5-Stage

Part #	Description	1+	4+	8+
C-161112	GRO-575B RO 5-STAGE; 75 GPD	\$363.00	\$332.75	\$302.50

FreshPoint 5-Stage Replacement Cartridges

Part #	Description	1+	12+	24+
C-655123-96	FDF1-RC, CARTRIDGE, SED/CARBON CTO	\$21.54	\$19.75	\$17.95
C-655122-96	GRO75-RC 75 GPD GRO MEMBRANE CARTRIDGE	\$64.51	\$59.14	\$53.76
C-655117-96	F1GC-RC POST FILTER CARTRIDGE	\$17.66	\$16.19	\$14.72

Part #	Description	1+	6+	12+
C-655126-96	F2B2-RC, CARTRIDGE FILTERS; TWIN PACK VOC	\$50.24	\$46.06	\$41.87

PENTEK RO-2550 REVERSE OSMOSIS SYSTEM



System Tested and Certified by NSF International against NSF/ANSI Standard 42, 53, 58, and CSA B483.1 for the reduction for the claims specified on the Performance Data Sheet.



Pentek RO-2550 RO Features:

- Includes 50 gallon per day reverse osmosis element
- Installed under the sink
- Water on demand delivered from a 2.8 gallon storage tank
- Automatic shut-off valve helps conserve water
- Reduces salts, dissolved minerals, bad taste and odor
- Designed for chlorinated and non-chlorinated water
- Reduces particles as small as 1/1000 of a micron in size by mechanical means

Pentek RO-2550 Reverse Osmosis System

Part #	Description	1+	12+	60+	120+
161079	RO-2550; 4 STAGE 50 GPD RO SYSTEM	\$308.77	\$260.93	\$239.19	\$217.44



GR/O REVERSE OSMOSIS SYSTEM "THE WATER SAVER"



GR/O RO System



Designer faucet included with certain models

GR/O Features:

- 50% Recovery Rate - 1 to 1 Ratio!
- John Guest® quick connect fittings
- 2 Year Warranty
- Conserves Water
- Innovative Design
- Saves Money

SAVE 4 TIMES THE WATER OF CONVENTIONAL RO'S

RO Systems

GR/O RO System "The Water Saver"

Part #	Description	1±	5±	24±
GR/O-HE-75	4 STAGE 75 GPD 3 HSG CHROME STANDARD FAUCET	\$237.79	\$224.58	\$217.97
GR/O-HE-75-D	4 STAGE 75 GPD 3 HSG CHROME DESIGNER FAUCET	\$243.99	\$230.44	\$223.66
GR/O-HE-75-XF	4 STAGE 75 GPD 3 HSG NO FAUCET	\$223.24	\$210.84	\$204.64



Retro Fit Kit

GR/O Retro Fit Kit

RO Filter Assembly Only - No Tank, Faucet or Install Kit

- Quick & simple replacement
- RO Filter assembly only, no tank, faucet or installation supplies
- Why replace the whole RO unit, when the tank and faucet are still good?

"Turn your old units into new"

GR/O Retro Fit Kit (RO Filter Assembly Only - No Tank, Faucet or Install Kit)

Part #	Description	1±	5±	24±
GR/O-HE-75-RK	4 STAGE 75 GPD HEAD 3 HOUSINGS	\$181.50	\$171.42	\$166.38



(93023)

GRO Filters

Part #	Description	1±	40±	200±
93023	PX05-9 7/8"; 5M SEDIMENT	\$2.48	\$2.31	\$2.21



(OMB934-MAX5)

Part #	Description	1±	20±	200±	1260±
OMB934-MAX5	10" 5M COCO CARBON BLOCK; USA	\$5.12	\$4.64	\$4.37	\$4.30

* Flow Restrictors on page (124)

GRO Membranes - High Recovery / 1:1 ratio Without Flow Restrictors (For 1:1 Ratio - Use Suggested Flow Restrictor - *Sold Separately)

Part #	Description	1±	16±	80±	160±
4005459	GRO-50EN; 50 GPD, NO CHECK VALVE & FLOW CNTRL	\$68.11	\$57.56	\$52.76	\$47.96
4005460	GRO-75EN; 75 GPD, NO CHECK VALVE & FLOW CNTRL	\$78.71	\$66.51	\$60.97	\$55.43



GRO Membrane

Membrane Accessories

Part #	Description	1±	25±	100±
FR2000JD-150	150 ML/MIN FLOW RESTRICTOR; 1/4QC (GRO-50EN)	\$4.63	\$4.32	\$4.01
FR2000JD-200	200 ML/MIN FLOW RESTRICTOR; 1/4QC (GRO-75EN)	\$4.63	\$4.32	\$4.01
ILCV09	INLINE CHECK VALVE; 1/4" QC (ALL GRO MEMBRANES)	\$6.75	\$6.30	\$5.85



Flow Restrictor (FR2000JD-___)



Check Valve (ILCV09)



PRO LINE REVERSE OSMOSIS SYSTEM

RO Systems



PRO LINE
4 Stage



50 GPD
PRO LINE Retro Fit Kit
4 Stage
(PRO LINE-50-RK)

PRO LINE Features:

- Non airgap faucet
- 3/8" Tubing from tank to faucet
- Carbon block pre-filter
- Carbon block post filter in 3rd housing

PRO LINE RO System

Part #	Description	1±	5±	24±	48±
PRO LINE-50	4 STAGE 50 GPD 3 HOUSINGS; STD FAUCET	\$213.33	\$202.66	\$192.00	\$181.33
PRO46T75P	4 STAGE 75 GPD 3 HSG; BOOSTER & ESO	\$352.72	\$335.08	\$317.45	\$299.81

Part #	Description	1±	5±	24±
PRO LINE-50-D	4 STAGE 50 GPD 3 HOUSINGS; DESIGNER FAUCE	\$189.37	\$178.85	\$173.59
PRO LINE-50-XF	4 STAGE 50 GPD 3 HOUSINGS; W/O FAUCET	\$168.15	\$158.81	\$154.14
PRO LINE-75	4 STAGE 75 GPD 3 HOUSINGS; STD FAUCET	\$184.13	\$173.90	\$168.78

PRO LINE Retro Fit Kit

RO Filter Assembly Only - No Tank, Faucet or Install Kit

- Quick & simple replacement
- RO Filter assembly only, no tank, faucet or installation supplies
- Why replace the whole RO unit, when the tank and faucet are still good?

**"Turn your old units
into new"**

PRO LINE Retro Fit Kit (RO Filter Assembly Only - No Tank, Faucet or Install Kit)

Part #	Description	1±	5±	24±
PRO LINE-50-RK	4 STAGE 50 GPD R/O HEAD ASSEMBLY	\$124.98	\$118.04	\$114.56



(93023)



(OMB934-MAX5)



(555964-00)

PRO Line Filters

Part #	Description	1±	40±	200±
93023	PX05-9 7/8"; 5M SEDIMENT	\$2.48	\$2.31	\$2.21

Part #	Description	1±	20±	200±
OMB934-MAX5	10" 5M COCO CARBON BLOCK; USA	\$5.12	\$4.64	\$4.37

Part #	Description	1±	25±	125±	250±
555694-00	PRF TLC-50; DRY; NSF MEMBRANE	\$45.88	\$38.77	\$35.54	\$32.31



PUREVALUE REVERSE OSMOSIS SYSTEMS

PureValueRO



50 GPD

(PUREVALUE 4EZ50)



50 GPD

(PUREVALUE 5EZ50)



50 GPD

(PUREVALUE 5EZ50-RK)

PureValue Features:

- 50 gpd TFC membrane
- 5 micron prefilter
- Two carbon block prefilters
- NSF 3.2 gallon storage tank
- John Guest® quick connect fittings
- 1/4" From tank to faucet
- 2" x 10" GAC post filter
- Wrench

PureValue RO Systems

Part #	Description	1±	5±	24±
PUREVALUE 4EZ50	4 STAGE 50 GPD	\$147.87	\$139.66	\$135.55
PUREVALUE 4EZ50-D	4 STAGE 50 GPD; DESIGNER FAUCET	\$154.08	\$145.52	\$141.24
PUREVALUE 4EZ50-XF	4 STAGE 50 GPD; W/O FAUCET	\$132.61	\$125.24	\$121.56
PUREVALUE 4EZ50-3/8	4 STAGE 50 GPD; 3/8"	\$145.49	\$137.41	\$133.37
PUREVALUE 4EZ50-3/8-D	4 STAGE 50 GPD; 3/8"; DESIGNER FAUCET	\$156.94	\$148.22	\$143.86
PUREVALUE 4EZ50-3/8-XF	4 STAGE 50 GPD; 3/8"; W/O FAUCET	\$135.95	\$128.40	\$124.62
PUREVALUE 5EZ50	5 STAGE 50 GPD	\$171.72	\$162.18	\$157.41
PUREVALUE 5EZ50-D	5 STAGE 50 GPD; DESIGNER FAUCET	\$177.45	\$167.59	\$162.66
PUREVALUE 5EZ50-XF	5 STAGE 50 GPD; W/O FAUCET	\$156.22	\$147.54	\$143.20
PUREVALUE 5EZ50-3/8	5 STAGE 50 GPD; 3/8"	\$175.30	\$165.56	\$160.69
PUREVALUE 5EZ50-3/8-D	5 STAGE 50 GPD; 3/8"; DESIGNER FAUCET	\$181.98	\$171.87	\$166.82
PUREVALUE 5EZ50-3/8-XF	5 STAGE 50 GPD; 3/8"; W/O FAUCET	\$159.80	\$150.92	\$146.48

PureValue Retro Fit Kit

RO Filter Assembly Only - No Tank, Faucet or Install Kit

- Quick & simple replacement
- RO Filter assembly only, no tank, faucet or installation supplies
- Why replace the whole RO unit, when the tank and faucet are still good?

"Turn your old units into new"

PureValue Retro Fit Kit

(RO Filter Assembly Only - No Tank, Faucet or Install Kit)

Part #	Description	1±	5±	24±	48±
PUREVALUE 4EZ50-RK	4 STAGE FILTER ASSEMBLY; 50 GPD	\$94.45	\$89.20	\$86.58	
PUREVALUE 5EZ50-3/8-RK	5 STAGE FILTER ASSEMBLY; 50 GPD; 3/8"	\$120.92	\$114.21	\$110.85	
Part #	Description	1±	5±	24±	48±
PUREVALUE 4EZ50-3/8-RK	4 STAGE FILTER ASSEMBLY; 50 GPD; 3/8"	\$117.40	\$111.53	\$105.66	\$99.79
PUREVALUE 5EZ50-RK	5 STAGE FILTER ASSEMBLY; 50 GPD	\$119.78	\$113.80	\$107.81	\$101.82

PureValue Filters



(1227867-V)

Part #	Description	1±	40±	400±	1440±
1227867-V	VX05-9 7/8"; 5M SEDIMENT	\$1.21	\$1.17	\$1.13	\$1.05



(32-250-10-MATRIKX(R))

Part #	Description	1±	20±	100±	200±
32-250-10-MATRIKX(R)	MATRIKX CTO 10"; 5M CARBON BLOCK	\$3.77	\$3.25	\$3.06	\$2.92



(CL10ROT40-B)

Part #	Description	1±	25±	125±	250±
CL10ROT40-B	INLINE 2" X 10" POST CARBON; 1/4" FPT	\$7.61	\$6.95	\$6.19	\$5.90
VX-TW30-50D	VALUTREX 50 GPD TFC-DRY MEMBRANE	\$17.88	\$16.76	\$15.65	\$14.53



(VX-TW30-50D)

RO Systems



PuROTwist REVERSE OSMOSIS SYSTEMS



PuROTwist

RO Systems



PuROTwist 4000 Series
(PT4000T50-SS NA)

PuROTwist Features:

- John Guest® fittings
- Drain connector
- Feed supply
- Tank ball valve
- Omnipure® filters
- Auto shut off valve
- 3/8" From tank to faucet for full flow

Options include:

- Permeate Pump
- Booster Pump
- UV Light
- Water Quality Monitor
- Large Holding Tank.

4 Stage PuROTwist Reverse Osmosis Systems

Part #	Description	1+	5+	24+
PT4000T50-SS NA	PT4000-50 TFC NON-AIR GAP	\$244.71	\$231.11	\$224.31
PT4000T50-SS AG	PT4000-50 TFC AIR GAP	\$274.54	\$260.82	\$247.09



PuROTwist 4000 Series
Retro Fit Kit
(PT4000T50-RK)

PuROTwist Retro Fit Kit

RO Filter Assembly Only - No Tank, Faucet or Install Kit

- Quick & simple replacement
- RO Filter assembly only, no tank, faucet or installation supplies
- Why replace the whole RO unit, when the tank and faucet are still good?

“Turn your old units into new”

4 Stage PuROTwist Retro Fit Kits (RO Filter Assembly Only - No Tank, Faucet, Install Kit)

Part #	Description	1+	5+	24+
PT4000T50-RK	4 STAGE 50 GPD	\$187.94	\$177.50	\$172.28
PT4000T50-SS-RK	4 STAGE 50 GPD; SILKSCREEN PT LOGO	\$206.44	\$196.12	\$185.80



(Q5605)

PuROTwist Filters

Part #	Description	1+	25+	125+	250+
Q5605	2.5" X 12" 5M SEDIMENT	\$12.72	\$11.60	\$10.33	\$9.86
Q5640	2.5" X 12" T40 COCONUT GAC	\$14.24	\$13.00	\$11.57	\$11.04



(Q5640)

Part #	Description	1+	25+	125+
TQ56-36FC/NSF	Q TFC 36GPD NSF ENCAPSULATED MEMBRANE W/ FC	\$44.06	\$41.12	\$38.18
TQ56-50FC	Q TFC 50GPD ENC MEMBRANE W/550 ML FC	\$52.09	\$48.62	\$45.15



(TQ56-36FC/NSF)

O-Rings

Part #	Description	1+	10+	50+	100+
H-011	Q-SERIES HEAD O-RING; SMALL	\$0.41	\$0.38	\$0.34	\$0.32
H-118	Q-SERIES HEAD O-RING; LARGE	\$0.41	\$0.38	\$0.34	\$0.32



SEMI COMMERCIAL RO ASSEMBLIES



50 GPD
5 Stage TFC Filter
Retro Fit Kit
(PL50T200-RK)

Retro Fit Kit:

- Quick & simple replacement
- RO Filter assembly only, no tank, faucet or installation supplies
- Why replace the whole RO unit, when the tank and faucet are still good?

“Turn your old units into new”

PuROLine Semi-Commercial Retro Fit Kit

Part #	Description	1±	5±	24±	48±
PL50T200-RK	5 STAGE (DUAL TFC100) 200GPD SYS.ONLY	\$184.05	\$173.83	\$168.72	
PRO LINE 5-150	5 STAGE 150 GPD R/O;3 HOUSING	\$318.00	\$302.10	\$286.20	\$270.30
PRO LINE 5-150-RK	5 STAGE 150 GPD R/O HEAD;3 HOUSING	\$151.00	\$143.45	\$135.90	\$128.35

COUNTER TOP UNITS

Design Your Own Filter System by using our already assembled, two or three stage system assemblies. Then choose from our wide selection of specialty filter cartridges in our filter section.



(H2O-RCT-CP)

Counter Top Filter Systems - With Filters

Part #	Description	1±	12±	96±	144±
H2O-RCT-CP	9" CT UNIT W/GAC/KDF FILTER	\$64.93	\$57.14	\$54.54	\$51.94
H2O-RCT-CP-CB	9" CT UNIT W/1UM ECOCARB FILTER	\$60.62	\$53.35	\$50.92	

H2O International Replacement Filters for (H2O-RCT-CP)

Part #	Description	1±	18±	108±	180±
H2O-GAC/KDF-PLUS	9" GAC/KDF FILTER	\$24.51	\$21.57	\$20.59	\$19.61



(QMP602-C)

Counter Top Filter Systems - Without Filters

Part #	Description	1±	12±	60±	120±
H2O-RCT-CPH	9" CT UNIT W/O FILTER	\$37.82	\$33.28	\$31.77	\$30.26
QMP602	10" CT UNIT; ASSEMBLED; COMPLETE; WHITE	\$49.83	\$46.59	\$44.65	\$41.41
QMP602-C	10" CT; ASSEMBLED; COMPLETE; CHROME	\$80.07	\$74.87	\$71.76	\$66.56



Two Stage Filter System
(QMP603)

Part #	Description	1±	4±	20±	40±
QMP603	10" 2-STAGE CT; ASSEMBLED; COMPLETE; WHITE	\$64.72	\$60.52	\$58.00	\$53.80
QMP603-C	10" 2-STAGE CT; ASSEMBLED; COMPLETE; CHROME	\$149.98	\$140.24	\$134.40	\$124.66

Counter Top with UV Filter System

Part #	Description	1±	4±	20±	40±
QMP605	10" CT/UV; 5 MIC; COMP; 120V-WHITE	\$113.87	\$106.48	\$102.04	\$94.65

Digipure Counter Top Filter Systems - With Filters

Part #	Description	1±	10±	50±
SA168	9000S C/T UNIT; GAL; CTO/2; CHROME	\$58.24	\$54.36	\$50.47
SA168-W/O FILTER	9000S C/T UNIT; GAL; NO FILTER; CHROME	\$53.27	\$49.72	\$46.17
SA168L	9000S C/T UNIT; LITERS; CTO/2; CHROME	\$49.29	\$46.01	\$42.72
SA168L-W/O FILTER	9000S C/T UNIT; LITERS; NO FILTER; CHROME	\$53.27	\$49.72	\$46.17
SA178	9000S C/T UNIT; GAL; CTO/2; WHITE	\$51.88	\$48.42	\$44.96
SA178-W/O FILTER	9000S C/T UNIT; GAL; NO FILTER; WHITE	\$46.91	\$43.78	\$40.66
SA178L	9000S C/T UNIT; LITER; CTO/2; WHITE	\$43.73	\$40.81	\$37.90
SA178L-W/O FILTER	9000S C/T UNIT; LITER; NO FILTER; WHITE	\$39.36	\$36.73	\$34.11



(SA168)

RO Systems



UNDER SINK FILTRATION



PuROTwist
Filter System
(PT2000-NVH)



Two Stage
Filter System
(FS-2A)

Under Sink Filtration

Part #	Description	1+	5+	24+	48+
PT2000-NVH	2 STAGE NON VALVED HEAD; Q5605, Q5633	\$87.45	\$83.08	\$78.71	\$74.34
FS-3A-3/8	3 STAGE W/O FILTERS 3/8"	\$75.53	\$71.75	\$67.98	\$64.20

Part #	Description	1+	5+	24+
PT2000-VH	2 STAGE VALVED HEAD; Q5605, Q5633	\$87.30	\$82.45	\$80.02
FS-2A	2 STAGE W/O FILTERS 1/4" FPT	\$34.59	\$32.67	\$31.71
FS-2A-1/2	2 STAGE W/O FILTERS 1/2"	\$53.19	\$50.24	\$48.76
FS-3A	3 STAGE ASSEMBLY W/O FILTERS 1/4" FPT	\$59.87	\$56.54	\$54.88

RO Systems

POINT OF ENTRY FILTRATION



(FR-2BB-WOF)



(FR-3BB-WOF)

Point Of Entry Filtration - 20" BB

Part #	Description	1+	4+	24+	48+
FR-1BB-WOF	1 STAGE BB W/O FILTERS 1" FPT	\$62.54	\$59.42	\$56.29	\$53.16

Part #	Description	1+	5+	24+
FR-2BB-WOF	2 STAGE BB W/O FILTERS 1" FPT	\$143.10	\$135.15	\$131.18
FR-3BB-WOF	3 STAGE BB W/O FILTERS 1" FPT	\$216.09	\$204.08	\$198.08

ULTRA FILTRATION SYSTEM



(HS-UF440)

High Springs Ultra Filtration System

Part #	Description	1+	2+	5+
HS-UF440	3/4" PORTING 4x40 MEMBRANE W/ AUTO FLUSH	\$3,461.77	\$3,147.06	\$3,021.18
HS-UF440 MEMBRANE	4x40 MEMBRANE REPLACEMENT	\$757.90	\$689.00	\$661.44

FEATURES:

- Intelligent Self Cleaning System Using a Solenoid Valve to Drain for Selectable Time and Duration
- 3-PP True Union Ball Valve By-Pass Configuration to Provide Complete Redundancy
- Ultra Filter Membrane uses Patented Multi-Bore Technology to Provide Consistent Product
- NSF Certified 61 on all Materials of Construction; NSF/ANSI 419 Drinking Water Equipment Performance-Filtration
- 0.03UM Membrane for Certified Removal of Cryptosporidium and Virus Reduction

ULTRA FILTRATION OPERATING PARAMETERS:

- Pressure Requirements: Minimum 40 PSI; Maximum 80 PSI
- Temperatures Requirements: Minimum 5° C; Maximum 35° C
- Solenoid Electrical Requirements: 110V, 1 Phase, Meets CSA Standards
- Membrane Life Expectancy: 1-2 Years Before Replacement is Needed



COMMERCIAL REVERSE OSMOSIS SYSTEMS

GOOD WATER WAREHOUSE, INC. can provide you with commercial & light industrial reverse osmosis systems for different applications. Our systems range from 150 gpd to 1 million gpd for tap, well, municipal and sea water applications. Full packages with pre and post treatment are also available. For special applications or larger commercial units please contact GWW.

RO Systems

Reverse Osmosis Compact I Units

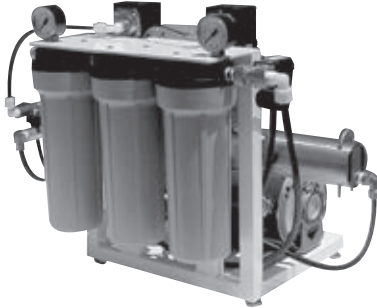

Compact I
(ROS/COMP-___)



Part #	Description	1±	2±	5±
ROS/COMP-150	175 GPD R/O COMPACT I; 110/60	\$1,930.72	\$1,847.97	\$1,792.81
ROS/COMP-250	250 GPD R/O COMPACT I; 110/60	\$2,089.71	\$2,000.16	\$1,940.45
ROS/COMP-450	450 GPD R/O COMPACT I; 110/60	\$2,120.00	\$2,029.15	\$1,968.57
ROS/COMP-800	800 GPD R/O COMPACT I; 110/60	\$2,263.86	\$2,166.84	\$2,102.16

STANDARD FEATURES:

- Thin film composite membrane
- Stainless steel membrane vessel
- Powder-coated steel frame
- Liquid-filled system pressure gauge
- Inlet/Outlet pre-filter gauges
- Fixed waste/recycle flow controls, stainless steel
- High-pressure nylon tubing
- High-pressure brass comp. fittings
- Storage tank pressure switch
- Feed water inlet solenoid valve
- Feed water low pressure switch
- Rotary vane pump
- 1/2 hp motor (150-450 gpd)
- 3/4 hp motor (800 gpd)
- 10" 5 micron sediment pre-filter (1)
- 10" carbon block pre-filters (2)
- 110 volt-50/60hz

OPTIONS:

- Nanofiltration membrane
- Super Hi-Flow membrane
- Float switch for atmospheric tank
- 220 volt-50/60hz
- Wall Mount Design
- Low pressure models ideal for less than 2000 TDS water.

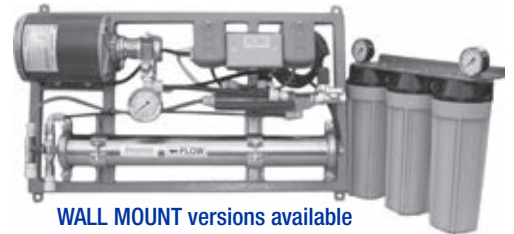

WALL MOUNT versions available
call for details.

Reverse Osmosis Compact II Units

Part #	Description	1±	2±	5±
ROS/COMP-II-150	175 GPD COMPACT II RO; 120/60	\$2,506.15	\$2,398.74	\$2,291.33
ROS/COMP-II-250	250 GPD COMPACT II RO; 120/60	\$2,566.72	\$2,456.71	\$2,383.38
ROS/COMP-II-450	450 GPD COMPACT II RO; 120/60	\$2,634.86	\$2,521.94	\$2,446.66
ROS/COMP-II-800	800 GPD COMPACT II RO; 120/60	\$2,884.72	\$2,761.09	\$2,678.67



Compact II Unit Options

Part #	Description	1±	2±	5±
ROS/COMP-II-FLOWMTR	PROD/WASTE FM	\$249.86	\$239.15	\$228.44

STANDARD FEATURES:

- Thin film composite membrane
- Stainless steel membrane vessel
- Powder-coated steel frame
- Liquid-filled system pressure gauge
- Liquid-filled Inlet/Outlet pre-filter gauges
- Pressurized tank pressure gauge
- Fixed waste/recycle flow controls, stainless steel
- High-pressure nylon tubing
- High-pressure brass comp. fittings
- Storage tank pressure switch
- Feed water inlet solenoid valve
- Feed water low pressure switch
- Rotary vane pump
- 1/2 hp motor (150-450 gpd)
- 3/4 hp motor (800 gpd)
- 20" 5 micron sediment pre-filter (1)
- 20" carbon block pre-filter (1)
- 110 volt-50/60hz

OPTIONS:

- Nanofiltration membrane
- Super Hi-Flow membrane
- Float switch for atmospheric storage tank
- TDS digital monitor
- Product and waste flow meters includes adjustable waste/recycle valves
- 220 volt-50/60hz
- Low pressure models ideal for less than 2000 TDS water.



Compact II
(ROS/COMP-II-___)



Pro Line Ultra Series - Commercial RO

Part #	Description	1±	2±
ULTRA-2600	2600 GPD; 110V; BASIC ULTRA LOW ENERGY	\$3,209.23	\$2,766.57
ULTRA-2600-D	2600 GPD; 110V; DELUXE ULTRA LOW ENERGY	\$3,388.05	\$2,920.73
ULTRA-5200B	5200 GPD; 110V; BASIC ULTRA LOW ENERGY	\$3,793.44	\$3,270.20
ULTRA-5200-D	5200 GPD; 110V; DELUXE ULTRA LOW ENERGY	\$4,014.09	\$3,460.42

RO Systems



Ultra-2600-D
Shown In Photo

BASIC MODEL FEATURES:

- Webtrol Stainless Steel Multi-Stage Pump
- Motor Thermal Overload Protection
- VEOLIA AK-90LE Ultra Low Energy Membrane Elements
- Stainless Steel Membrane Housings
- 5 Micron Sediment Filter Cartridge
- Pentek 20" Big Blue Filter Housing
- Permeate Flow Meter
- Concentrate Flow Meter with Adjustable Needle Valve
- Recycle Flow Meter with Adjustable Needle Valve
- Low Pressure Switch
- Pump Operating Pressure Gauge
- Pre-Filter In/Out Pressure Gauge
- Product Water Check Valve
- Pretreatment Lockout
- Ideal for less than 2000 TDS water



DELUXE MODEL UPGRADED FEATURES:

- Auto-Flush Solenoid Valve & Multiple Programming
- Dual Probe TDS Meter
- Powder-Coated Aluminum Frame
- Codeline Fiberglass Membrane Housings

Pro Line Ultra Series - Commercial RO - Deluxe

Part #	Description	1±	2±
ULTRA-7800-D	7800 GPD RATED; 220V; ULTRA LOW ENERGY	\$5,858.68	\$5,050.59
ULTRA-10400-D	10400 GPD RATED; 220V; ULTRA LOW ENERGY	\$7,555.45	\$6,513.32
ULTRA-15600-D	15600 GPD RATED; 220V; ULTRA LOW ENERGY	\$8,530.64	\$7,354.00

DELUXE MODEL FEATURES:

- Powder-Coated Aluminum Frame
- Webtrol Stainless Steel Multi-Stage Pump
- Motor Thermal Overload Protection
- GE AK-90LE Ultra Low Energy Membrane Elements
- Codeline Fiberglass Membrane Housings
- iControls ROC 5 Controller with Conductivity Probe
- Auto-Flush Solenoid Valve & Multiple Programming
- 5 Micron Sediment Filter Cartridge
- Pentek 20" Big Blue Filter Housing
- Permeate Flow Meter
- Concentrate Flow Meter with Adjustable Needle Valve
- Recycle Flow Meter with Adjustable Needle Valve
- Low Pressure Switch
- Pump Operating Pressure Gauge
- Pre-Filter In/Out Pressure Gauge
- Pretreatment Lockout
- Product water tank level connection (Level Control not Inc.)
- Powered relay output
- Ideal for less than 2000 TDS water

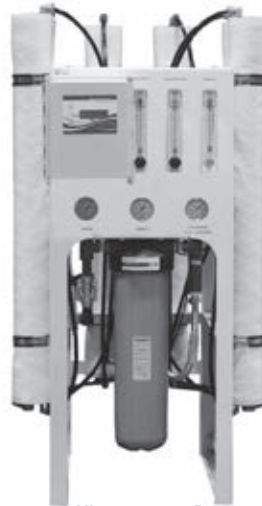

Ultra-15600-D
Shown In Photo





ESYBOX SYSTEMS



Store And Pressurize High Volume RO Water

Fully integrated electronic Pump system ...in a box. No further pump items required.

RO Systems

The EsyBox Pump System & The EsyBox tank system designed and plumbed for the EsyBox pump! A turn-key storage tank and pump, for your ULTRA RO systems! Fully integrated electronic booster pump.



ESYTANK 500 Mini



Use with EsyBox Mini 3

EsyTank 500 Mini 500 LITER (132GAL.) CAPACITY

The ESYTANK is made from food-grade, high-density polyethylene (HDPE) and comes pre-fitted with all essential components for easy integration: servo-controlled float valve, overflow system, foot-valve-equipped suction pipe, delivery pipe, and the ESYDOCK mounting base.

- Drinking water storage for use with pressure booster pumps
- Engineered specifically for DAB E.SYBOX Mini 3 integration
- Eliminates backflow risk and ensures compliance with mains supply regulations
- Includes essential installation fittings: float valve, suction & delivery pipe, E.SYDOCK
- Ideal for mains-boosting setups where direct connection is not permitted
- Compact footprint – suitable for installation in confined indoor areas
- Made from recyclable, potable-grade materials

EsyTank 500 Mini

Part #	Description	1±	4±
60219002	ESYTANK 500 MINI	\$960.80	\$799.54



ESYBOX Mini 3

EsyBox Mini 3 INTEGRATED WATER PRESSURE BOOSTER PUMP

The ESYBOX Mini3 is a water boosting pump designed for residential and small commercial use. The ESYBOX Mini3 creates constant pressure through VFD (Variable Frequency Drive) technology, optimizing its integrated inverter to reduce noise and water consumption.

- Automatic Voltage Detection: 115/230
- Self-priming, multi-stage pump
- Pressure and flow sensors
- High-resolution LCD display
- Integrated 0.5-gallon expansion tank
- Installs vertically or horizontally
- Constant pressure: set from 15 to 75 PSI



ESYBOX Pump

Esybox Mini 3

Part #	Description	1±	4±
60212610	ESYBOX MINI3 - NPT/DV/US1/G	\$1,183.10	\$984.52

Esybox Pump

Part #	Description	1±	4±
60212311	ESYBOX 230V NPT	\$2,260.81	\$1,901.51

Contact Us For Full List Of Other DAB Products



ESYBOX DIVER



ESYBOX BASE

EsyBox Diver

ESYBOX DIVER is a 7" multi-stage electronic pump with variable frequency drive for clean water designed for use in rain water tanks, wells, cisterns or tanks. Usable submerged, partially submerged or on the surface (with the appropriate accessory). The pump can also be installed horizontally.

Flow rate maximum	31.7gpm (7.2 m3/h)
Head up to	180ft (55m)
Maximum immersion depth	39ft (12m) standard version
Minimum suction depth	4.33" (110mm)
Minimum level of water	1.38" (35mm)
Liquid temperature range	From 32°F to 131°F (+0°C to +55°C)
Outlet connection	Threated 1" 1/4 NPT

Esybox Diver (DTRON2)

Part #	Description	1±	4±
60195643	45/90; 115V/60Hz NPT15USA5 - NSF	\$689.75	\$573.98
60197690	35/120; 115V/60Hz NPT15USA5 - NSF	\$729.02	\$606.66

Esybox Diver Base (Above Ground Adaptor)

Part #	Description	1±	4±
60192276	DOC 68 BASE	\$104.46	\$86.93



MEMBRANES & MEMBRANE HOUSINGS

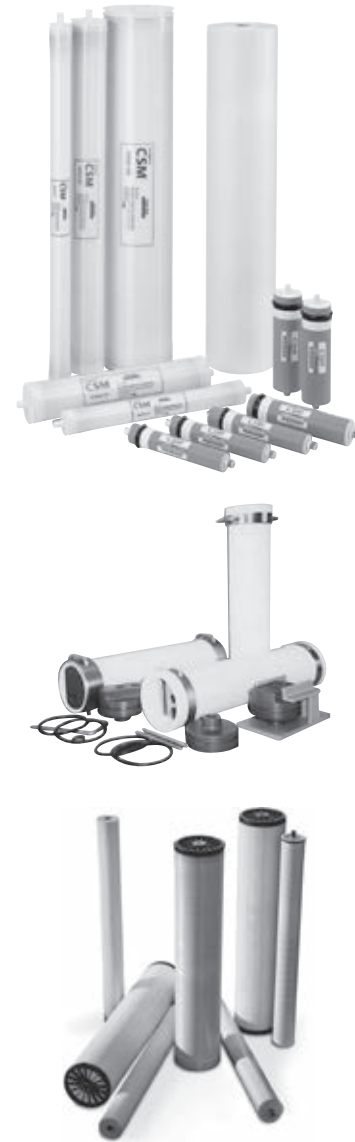

Membranes / Hous.



VALUTREX™ MEMBRANES



Valutrex™ Membranes

Part #	Description	CASE			
		1±	25±	125±	250±
VX-TW30-50D	50 GPD TFC-DRY	\$17.88	\$16.76	\$15.65	\$14.53
VX-TW30-75D	75 GPD TFC-DRY	\$19.56	\$18.34	\$17.12	\$15.89
VX-TW30-100D	100 GPD TFC-DRY	\$24.29	\$22.77	\$21.26	\$19.74
VX-TW30-150D	150 GPD TFC-DRY	\$30.87	\$28.94	\$27.01	\$25.08

PENTAIR® RESIDENTIAL MEMBRANES



Residential Membranes - NSF

Part #	Description	CASE			
		1±	25±	125±	250±
555694-00	TLC-50; DRY; NSF	\$45.88	\$38.77	\$35.54	\$32.31
655045-00	TLC-100; DRY; NSF	\$66.78	\$62.33	\$57.88	

PuROTWIST MEMBRANES



(TQ56-50FC)

PuROTWIST Membranes

Part #	Description	CASE		
		1±	25±	125±
TQ56-36FC	Q TFC 36 GPD ENC MEMBRANE W/ FC	\$43.16	\$40.28	\$37.40
TQ56-36FC/NSF	Q TFC 36 GPD NSF ENC MEMBRANE W/ FC	\$44.06	\$41.12	\$38.18
TQ56-100	Q TFC-100GPD ENC MEMBRANE W/OFC	\$50.82	\$47.43	\$44.05
TQ56-50FC	Q TFC 50 GPD ENC MEMBRANE W/ FC	\$52.09	\$48.62	\$45.15
TQ56-75FC	Q TFC75GPD ENC MEMBRANE W/FC	\$51.03	\$47.63	\$44.23
TQ56-150FC	Q TFC 150 GPD ENC MEMBRANE W/1000 ML FC	\$96.23	\$89.82	\$83.40

Compatible Filters
on page (98)

PENTAIR GRO HIGH RECOVERY (1:1 RATIO) ENCAPSULATED MEMBRANES



GRO Membrane
High Recovery 1:1 Ratio

GRO Membranes - High Recovery / 1:1 ratio Without Flow Restrictors (For 1:1 Ratio - Use Suggested Flow Restrictor - Sold Separately)

Part #	Description	CASE			
		1±	16±	80±	160±
4005459	GRO-50EN; 50GPD, NO CHECK VALVE & FLOW CNTRL	\$68.11	\$57.56	\$52.76	\$47.96
4005460	GRO-75EN; 75GPD, NO CHECK VALVE & FLOW CNTRL	\$78.71	\$66.51	\$60.97	\$55.43

Membrane Accessories

Part #	Description	1±	25±	100±
		FR2000JD-150	150 ML/MIN FLOW RESTRICTOR; 1/4QC (GRO-50EN)	\$4.63
FR2000JD-200	200 ML/MIN FLOW RESTRICTOR; 1/4QC (GRO-75EN)	\$4.63	\$4.32	\$4.01
ILCV09	INLINE CHECK VALVE; 1/4" QC (ALL GRO MEMBRANES)	\$6.75	\$6.30	\$5.85

Flow Restrictor
(FR2000JD-___)



Check Valve
(ILCV09)

More Flow Restrictors
on page (124)



HYDROTECH MEMBRANES



Hydrotech® Membrane
(33001068)

Hydrotech Membranes

Part #	Description	CASE			
		1±	10±	25±	50±
414-000-02	15 GPD CTA	\$122.48	\$116.12	\$109.76	\$101.81
414-000-04	15 GPD TFC	\$122.48	\$116.12	\$109.76	\$101.81
33001068	25 GPD TFC	\$72.54	\$68.77	\$65.00	\$60.29
414-000-06	36 GPD TFC	\$65.13	\$61.75	\$58.36	\$54.13
33001033	50 GPD TFC	\$83.01	\$78.70	\$74.39	\$69.00

MICROLINE MEMBRANES



Microline Original
(S-1224RS)

Microline Membranes

Part #	Description	CASE			
		1±	10±	25±	50±
S-1224RS	14 GPD CTA	\$58.67	\$52.23	\$49.17	\$46.80
S-1227RS	25 GPD TFC	\$52.07	\$46.35	\$43.64	\$41.53
S-1229RS	50 GPD TFC	\$51.34	\$48.67	\$46.00	\$42.67

CULLIGAN MEMBRANES [COMPATIBLE]



(ACT-50)

Culligan Membranes [Compatible]

Part #	Description	CASE		
		1±	25±	125±
ACT-36	CULLIGAN TFM-36 [FITS H8/83 AC15, AC30]	\$28.84	\$26.92	\$25.00
ACT-50	CULLIGAN TFM-50 [FITS H8/83 AC15, AC30]	\$29.82	\$27.83	\$25.84

ECO WATER MEMBRANES [COMPATIBLE]



ECO Compatible
(ET-213-16)

Eco Water Membranes [Compatible]

Part #	Description	CASE		
		1±	25±	125±
ET-213-16	16 GPD TFC MEMBRANE;ECO	\$29.51	\$27.54	\$25.57
ET-213-35	35 GPD TFC MEMBRANE;ECO	\$32.79	\$30.61	\$28.42

RAINSOFT MEMBRANES [COMPATIBLE]



Rainsoft Compatible
(TFC-RS9-12)

Rainsoft Membranes [Compatible]

Part #	Description	CASE		
		1±	25±	125±
TFC-RS9-12	TFC 12 GPD (FITS;9565, 9591, 9594,13016)	\$26.50	\$24.74	\$22.97
TFC-RS9-22	TFC 22 GPD (FITS;9568, 9596)	\$30.53	\$28.49	\$26.46
TFC-RS9-36	TFC 36 GPD	\$31.15	\$29.08	\$27.00
TFC-RS9-50	TFC 50 GPD	\$32.79	\$30.61	\$28.42

WATER FACTORY MEMBRANES



Water Factory / CUNO
(66-4706G-2)

Water Factory Membranes

Part #	Description	CASE			
		1±	10±	25±	50±
66-4706G-2	SQC 36 GPD TFC	\$274.05	\$243.95	\$229.69	\$218.61

Compatible Filters
on page (98)

Membranes / Hous.



VEOLIA COMMERCIAL MEMBRANES



Series- A- Brackish Water-Membrane Elements

Veolia offers multiple combinations of flow, energy consumption, and rejection to best fit you needs. From the highest rejecting AG Series elements to the ultra-low energy/pressure AK Series elements. As well as offering UF and NF membrane options.



Commercial Membranes



Filmtec Style



AG-Series Tap Water/Brackish RO Elements, Dry Filmtec Style (Product Flow @ 225 PSI)

Part #	Description	CASE		
		1±	4±	12±
1206719	AG2521TF; 2.5" X 21" 300 GPD TFC; TAPE	\$159.38	\$150.99	\$147.64
1206729	AG2540TF; 2.5" X 40" 710 GPD TFC; TAPE	\$200.48	\$189.93	\$185.71
1206750	AG4021TF; 4" X 21" 1050 GPD TFC; TAPE	\$244.90	\$232.01	\$226.85
3032514	AG4040TM; 4" x 40" 2300 GPD; TAPE	\$223.23	\$211.48	\$206.78
3032513	AG4040FM; 4" x 40" 2300 GPD; FIBER	\$201.40	\$190.80	\$186.56

AK-Series Low Pressure RO Elements, Dry Filmtec Style (Product flow @ 107 PSI)

Part #	Description	CASE		
		1±	4±	12±
1206799	AK2521TF; 2.5" X 21" 300 GPD TFC; TAPE	\$159.30	\$150.92	\$147.56
1206812	AK4021TF; 4" X 21" 1050 GPD TFC; TAPE	\$337.35	\$319.59	\$312.49
3039082	AK4040FM; 4" x 40" 2300 GPD; FIBER	\$223.23	\$211.48	\$206.78
1206802	AK2540TF; 2.5" X 40" 710 GPD TFC; TAPE	\$211.31	\$200.19	\$195.74

AK-Series High Rejection RO Elements, Dry Filmtec Style (Product Flow @ 120 PSI)

Part #	Description	CASE		
		1±	4±	12±
3056683	AK-90LE; 4" x40";HR;ULE; 2800 GPD;110PSI; F	\$258.09	\$244.51	\$239.07

H-Series Nano Filtration Elements

Part #	Description	CASE		
		1±	4±	12±
1207240	HL8040F-400 11,500 GPD NANO	\$1,082.53	\$1,025.55	\$1,002.76
1207236	HL4040FM; 2500 GPD; NANO	\$421.94	\$399.73	\$390.85

Membranes / Hous.



FILMTEC™ RESIDENTIAL & COMMERCIAL MEMBRANES

FILMTEC™ Membranes



Residential Membrane Element

Residential Membrane Elements

Part #	Description	CASE		
		1±	25±	125±
TW30-1812-50HR	1.8" x 12" 50 GPD	\$29.68	\$28.84	\$27.56
BW60-1812-75D	1.8" x 12" 75 GPD HR ELEMENT-DRY	\$31.17	\$30.28	\$28.94
TW30-1812-100HR	1.8" x 12" 100 GPD	\$33.32	\$32.37	\$30.94



Tap Water Membrane Elements

Tap Water Membrane Elements

Part #	Description	CASE		
		1±	12±	40±
TW30-2514	2.5" x 14" 170 GPD	\$177.78	\$172.70	\$165.08
TW30-2521	2.5" x 21" 300 GPD	\$270.53	\$262.80	\$251.21
TW30-2540	2.5" x 40" 660 GPD	\$207.76	\$201.83	\$192.92

Part #	Description	CASE		
		1±	4±	12±
TW30HP-4611	4.6" x 11" 1200 GPD	\$630.70	\$612.68	\$585.65
TW30-4014	4" x 14" 480 GPD	\$354.68	\$344.55	\$329.35
TW30-4021-DRY	4" x 21" 900 GPD; DRY	\$460.04	\$446.90	\$427.18
TW30 PRO 4040	4" x 40" 2400 GPD TW ELEMENT-DRY	\$340.72	\$330.99	\$316.39



XLE Series
Tap Water Membrane Element

Tap Water Low Energy Membrane 150PSI

Part #	Description	CASE		
		1±	12±	40±
LC LE-4040	4" x 40" 2500 GPD BW-LE 150PSI-LRG COMM	\$310.16	\$301.30	\$288.01

Tap Water - Extra Low Energy 100PSI

Part #	Description	CASE		
		1±	12±	40±
XLE-2521	2.5" x 21" 300 GPD	\$242.29	\$235.37	\$224.98
XLE-2540	2.5" x 40" 770 GPD	\$255.07	\$247.78	\$236.85



Brackish Water Membrane Element

Part #	Description	CASE		
		1±	4±	12±
XLE-4021	4" x 21" 1000 GPD	\$371.00	\$360.40	\$344.50
XLE PRO 4040	4" x 40" 2600 GPD TW MEM-XLE (DRY)	\$371.00	\$360.40	\$344.50

Brackish Water Membrane Element

Part #	Description	CASE		
		1±	4±	12±
BW30 PRO-400-34	8" X 40" 10500 GPD 34 MIL SPACER	\$888.86	\$863.47	\$825.37

Nano Membrane Elements

Part #	Description	CASE		
		1±	4±	12±
NF90-2540	2.5" x 40" 600 GPD	\$381.39	\$370.50	\$354.15
NF90-4040	4" x 40" 1850 GPD	\$500.11	\$485.82	\$464.39

Sea Water Membrane Elements

Part #	Description	CASE		
		1±	12±	40±
SW30-2540	2.5" x 40" 540 GPD	\$252.28	\$245.08	\$234.26



Sea Water Element Membranes

Part #	Description	CASE		
		1±	4±	12±
SW30-4040	4" x 40" 1500 GPD	\$460.04	\$446.90	\$427.18

Membranes / Hous.



GLOBAL AQUA MEMBRANES



Commercial 2.5" Membranes

Part #	Description	1±	4±	12±
MLP-2521	2.5 X 21 MEMBRANE 300 GPD 150PSI	\$97.86	\$90.34	\$85.82
MLP-2540	2.5 X 40 MEMBRANE 750 GPD 150PSI	\$145.52	\$134.33	\$127.61

Commercial 4" Membranes

Part #	Description	1±	4±	12±
MLP-4021	4 X 21 MEMBRANE 1100 GPD 150PSI	\$162.37	\$149.88	\$142.38
DFL-4040	4 X 40 LP MEMBRANE 2500 GPD 80PSI	\$239.00	\$220.61	\$209.58
XLP-4040	4 X 40 MEMBRANE 2500 GPD 100PSI	\$233.95	\$215.96	\$205.16
MLH-4040	4 X 40 LP MEMBRANE 2900 GPD 150PSI	\$219.49	\$202.60	\$192.47
MBW-4040	4 X 40 MEMBRANE 2400GPD 225 PSI	\$214.73	\$198.21	\$188.30

Commercial 8" Membranes

Part #	Description	1±	4±	12±
MLP-8040-400	8 X 40 MEMBRANE 11000 GPD 150PSI: 99.2% REJECTION	\$675.59	\$623.62	\$592.44

Membranes / Hous.

CSM[®] RESIDENTIAL & COMMERCIAL MEMBRANES



Residential

Part #	Description	1±	CASE 25±	125±
RE1812-35	1.8x12 35 GPD TFC	\$20.00	\$18.67	\$17.33
RE1812-80	1.8x12 80 GPD TFC	\$19.20	\$17.92	\$16.64
RE2012-100	2.0x12 100 GPD TFC	\$20.94	\$19.54	\$18.15
RE2012-LPF	2.0x12 150-200 GPD LOW PRESSURE	\$24.18	\$22.57	\$20.96

Commercial

Part #	Description	1±	CASE 4±	12±
RE2521-BLN	2.5x21; 300 GPD TW-LE	\$137.91	\$128.72	\$119.53
RE2540-BLF	2.5x40; 930 GPD ULTRA-LOW PRESSURE	\$163.88	\$152.95	\$142.03
RE8040-BLN	8x40; 12000 GPD BW-LE	\$730.11	\$681.44	\$632.76
RE2540-BE	2.5x40; 800 GPD BW	\$154.14	\$143.86	\$133.59
RE2540-BLN	2.5x40; 800 GPD BW-LOW PRESSURE	\$170.37	\$159.01	\$147.65
RE4040-BLF	4x40; 2500 GPD BW-XLE	\$283.94	\$265.01	\$246.08
RE4040-BLN	4x40; 2600 GPD TW-LE	\$259.60	\$242.30	\$224.99
RE8040-BLN-440	8x40; 13000 GPD BW-LE (440SQFT)	\$770.67	\$719.29	\$667.91





PENTAIR® MEMBRANE HOUSINGS



Membrane Housings

Part #	Description	CASE			
		1±	35±	175±	350±
144376	020-MVH90; M/H; SIDE PORT-WH;1/8"	\$15.72	\$13.28	\$12.18	\$11.07
Part #	Description	1±	10±	75±	
FW10FF	DOUBLE WRENCH; MEMBRANE/FILTER	\$2.39	\$2.23	\$2.07	

PENTEK



(144376)



(FW10FF)

CODELINE™ COMMERCIAL MEMBRANE HOUSINGS



CodeLine Fiberglass Vessels

Part #	Description	CASE		
		1±	4±	12±
40L30N-1W	4"X40" ECOLINE FRP VESSEL;300PSI;EP; WH	\$157.74	\$147.23	\$136.71
40E30N-1	4X40" 300 PSI FIBERGLASS VESSEL EP; WH	\$320.84	\$316.25	\$293.34
40E30N-2	4X80" 300 PSI FIBERGLASS VESSEL EP; WH	\$358.70	\$334.79	\$310.87
40E30N-3	4X120" 300 PSI FIBERGLASS VESSEL EP; WH	\$362.25	\$341.25	\$325.50



Call For Sizes and Pressure Ratings Not Listed

STAINLESS STEEL COMMERCIAL MEMBRANE HOUSINGS



Stainless Steel Housings (MH-4040SS.C)

Stainless Steel Housings

Part #	Description	CASE		
		1±	4±	12±
MH-2521SS.C	2.5" X 21" SS PRESSURE VESSEL	\$110.06	\$102.72	\$95.38
MH-2540SS.C	2.5" X 40" SS PRESSURE VESSEL	\$117.96	\$110.10	\$102.23
MH-4040SS.C	4" X 40" SS PRESSURE VESSEL	\$122.67	\$114.49	\$106.31
MH-4021SS.C	4" X 21" SS PRESSURE VESSEL	\$144.66	\$135.01	\$125.37
MH-4080SS.C	4" X 80" SS PRESSURE VESSEL	\$438.07	\$408.86	\$379.66

Membranes / Hous.



NOTES

Membranes / Hous.

A large, light blue watermark of the GOOD logo and a globe is centered on the page. The logo consists of the word 'GOOD' in a bold, sans-serif font, with a globe graphic behind it. The globe shows latitude and longitude lines. The entire page is overlaid with horizontal blue lines for writing.



FILTER CARTRIDGES & HOUSINGS



Housings / Filters



PENTAIR® SLIMLINE FILTER HOUSINGS [1/4", 3/8" & 1/2" INLETS]



PENTEK



10" White Housing
(158739)



10" Slim Line® Housing
(158006)



10" Clear Housing
(158214)



SW-1 Wrench
(150539)



O-Ring
(151121)

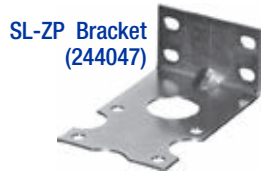

SL-ZP Bracket
(244047)

More Brackets
on on page (127)

10" Slim Line® Housings with 1/4" Caps

Part #	Description	CASE			
		1±	12±	60±	120±
158114	SL BLUE/BLACK; WO/PR	\$15.31	\$12.93	\$11.86	\$10.78
158117	SL CLEAR/BLUE; W/PR	\$23.60	\$19.94	\$18.28	\$16.62
158125	SL WHITE/WHITE; WO/PR	\$12.42	\$10.49	\$9.62	\$8.74
158739	SL #10 FLAT CAP WHITE/WHITE W/O PR	\$16.59	\$14.02	\$12.85	\$11.68

10" Slim Line® Housings with 3/8" Caps

Part #	Description	CASE			
		1±	12±	60±	120±
158006	SL BLUE/BLACK; WO/PR	\$15.87	\$13.41	\$12.30	\$11.18
158005	SL BLUE/BLACK; W/PR	\$17.55	\$14.83	\$13.60	\$12.36
158008	SL CLEAR/BLUE; W/O PR	\$26.10	\$22.06	\$20.22	\$18.38
158007	SL CLEAR/BLUE; W/PR	\$26.15	\$22.10	\$20.26	\$18.41
158098	SL WHITE/WHITE; WO/PR	\$16.47	\$13.92	\$12.76	\$11.60

10" Slim Line® Housings with 1/2" Caps

Part #	Description	CASE			
		1±	12±	60±	120±
158196	SL BLUE/BLACK; WO/PR	\$21.97	\$18.57	\$17.02	\$15.47
158195	SL BLUE/BLACK; W/PR	\$25.77	\$21.78	\$19.96	\$18.15
158215	SL CLEAR/BLUE; WO/PR	\$34.76	\$29.37	\$26.93	\$24.48
158214	SL CLEAR/BLUE; W/PR	\$34.76	\$29.37	\$26.93	\$24.48

20" Slim Line® Housings with 1/2" Caps

Part #	Description	CASE			
		1±	8±	40±	80±
158205	SL BLUE/BLACK; WO/PR	\$44.60	\$37.69	\$34.55	\$31.41
158204	SL BLUE/BLACK; W/PR	\$48.07	\$40.62	\$37.24	\$33.85

Slim Line® Accessories

Part #	Description	CASE			
		1±	50±	250±	500±
150539	SW-1A SPANNER WRENCH; SLIM LINE	\$5.03	\$4.25	\$3.90	\$3.54
151039	PRESS. RELIEF BTN KIT (EXCEPT VIH ASSEMBLIES)	\$4.61	\$3.90	\$3.57	\$3.25
Part #	Description	CASE			
		1±	10±	50±	100±
151121	O-RING; SLIM LINE HOUSINGS	\$3.18	\$2.69	\$2.46	\$2.24
244047	SL-ZP BRACKET KIT [L]	\$6.71	\$5.67	\$5.20	\$4.73

Housings / Filters



PENTAIR® STANDARD FILTER HOUSINGS [3/4" INLETS]



PENTEK

10" Housing
3/4" Cap - Clear
(150071)



10" Housing
3/4" Cap
Valve In Head
(150164)

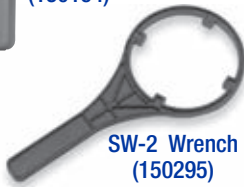

SW-2 Wrench
(150295)



O-Ring
(151120)

More Brackets
on page (127)

10" Housings with 3/4" Caps

Part #	Description	CASE			
		1±	12±	60±	120±
150067	BLUE/BLACK W/PR, W/MTG Caps	\$32.79	\$27.71	\$25.40	\$23.09
150068	BLUE/BLACK; WO/PR W/MTG Caps	\$32.79	\$27.71	\$25.40	\$23.09
150072	CLEAR/BLUE; WO/PR W/MTG Caps	\$45.43	\$38.39	\$35.19	\$31.99
150071	CLEAR/BLUE; W/PR W/MTG Caps	\$42.16	\$35.63	\$32.66	\$29.69
150164	VALVE IN HEAD; BLUE; W/PR	\$64.88	\$54.83	\$50.26	\$45.69
150437	VALVE IN HEAD; CLEAR; W/PR	\$71.19	\$60.16	\$55.15	\$50.13
150015	HIGH TEMP; RED; NYLON; WO/PR	\$189.10	\$159.80	\$146.49	\$133.17

20" Housings with 3/4" Caps

Part #	Description	CASE			
		1±	8±	40±	80±
150070	BLUE/BLACK; WO/PR W/MTG Caps	\$56.09	\$47.40	\$43.45	\$39.50
150069	BLUE/BLACK; W/PR W/MTG Caps	\$55.87	\$47.21	\$43.28	\$39.34
150166	VALVE IN HEAD; BLUE; W/PR	\$87.16	\$73.65	\$67.52	\$61.38
150111	HIGH TEMP; RED; WO/PR	\$287.72	\$243.14	\$222.88	\$202.62

Standard Housing 3/4" Accessories

Part #	Description	CASE			
		1±	50±	250±	500±
150295	SW-2 SPANNER WRENCH; 3/4" HOUSING	\$4.99	\$4.22	\$3.87	\$3.51
151039	PRESS. RELIEF BTN KIT (EXCEPT VIH ASSEMBLIES)	\$4.61	\$3.90	\$3.57	\$3.25
Part #	Description	1±	10±	50±	100±
151120	O-RING; 3/4" STANDARD FILTER HOUSINGS	\$2.63	\$2.22	\$2.04	\$1.85
150578	MC-1A BRACKET KIT [L]; W/SCREWS	\$9.27	\$7.83	\$7.18	\$6.53
151011	UB-1 VIH BRACKET KIT [U]	\$10.67	\$9.02	\$8.27	\$7.51

Housings / Filters



PENTAIR® BIG BLUE [BB] FILTER HOUSINGS



PENTEK

10" Big Blue®
Housing
(150237)



10" BB Clear Housing
1" Cap W/PR
(166219)

20" BB Housing
1" Cap
(150234)



(Spanner Wrench)



O-Ring
(151122)



(144259)

More Brackets
on page (127)

10" Big Blue® Housings with 3/4" Caps

Part #	Description	1±	6±	30±	60±
150470	HFPP; WO/PR	\$48.04	\$40.60	\$37.22	\$33.83
150469	HFPP; W/PR	\$47.15	\$39.84	\$36.52	\$33.20

10" Big Blue® Housings with 1" Caps

Part #	Description	1±	6±	30±	60±
150238	HFPP; WO/PR	\$47.53	\$40.16	\$36.82	\$33.47
150237	HFPP; W/PR	\$46.86	\$39.60	\$36.30	\$33.00

10" Big Clear Housings with 1" Caps

Part #	Description	1±	6±	30±	60±
166219	1" #10 BIG CLEAR; W/PR	\$151.80	\$128.28	\$117.59	\$106.90

20" Big Blue® Housings with 3/4" Caps

Part #	Description	1±	4±	20±	40±
150468	HFPP; WO/PR	\$66.57	\$56.26	\$51.57	\$46.88
150467	HFPP; W/PR	\$66.53	\$56.22	\$51.54	\$46.85

20" Big Blue® Housings with 1" Caps

Part #	Description	1±	4±	20±	40±
150234	HFPP; WO/PR	\$70.47	\$59.55	\$54.59	\$49.62
150233	HFPP; W/PR	\$71.72	\$60.61	\$55.56	\$50.51

20" Big Blue® Housings with 1.5" Caps

Part #	Description	1±	4±	20±	40±
150236	HFPP; WO/PR	\$76.88	\$64.97	\$59.56	\$54.14
150235	HFPP; W/PR	\$69.29	\$58.55	\$53.67	\$48.79

20" Big Clear Housings with 1" Caps

Part #	Description	1±	4±	20±	40±
166201	1" #20 BIG CLEAR W/PR	\$154.50	\$138.06	\$126.01	\$113.96

Big Blue® Accessories

Part #	Description	1±	50±	250±	500±
150296	10" BB; SW-3 SPANNER WRENCH	\$5.28	\$4.46	\$4.09	\$3.72
144368	20" BB; SW-4 SPANNER WRENCH	\$5.28	\$4.46	\$4.09	\$3.72
144880	BIG WHITE / CLEAR WRENCH	\$7.14	\$6.03	\$5.53	\$5.03
Part #	Description	1±	10±	50±	100±
151122	O-RING BIG BLUE FILTER HOUSINGS	\$8.28	\$7.00	\$6.42	\$6.07
151362	O-RING BIG CLEAR FILTER HOUSINGS	\$9.70	\$8.19	\$7.51	\$6.83
Part #	Description	1±	50±	250±	500±
151039	PRESS. RELIEF BTN KIT (EXCEPT VIH ASSEMBLIES)	\$4.61	\$3.90	\$3.57	\$3.25
Part #	Description	1±	5±	25±	50±
150061	SINGLE BB BRACKET ZINC PLATED [L]	\$47.48	\$40.13	\$36.78	\$33.44
357640	SINGLE BB BRACKET SS WITH SCREWS [L]	\$66.19	\$55.94	\$51.28	\$46.61
144258	TWO HOUSING BIG BLUE BRACKET	\$74.58	\$63.03	\$57.78	\$52.52
144259	THREE HOUSING BIG BLUE BRACKET	\$127.73	\$107.94	\$98.94	\$89.95

Good Water Warehouse BB Brackets (Lag Bolts Ordered Separately)

Part #	Description	1±	25±	50±	
BB-L-1020	BB SINGLE L BRACKET; WHITE	\$11.33	\$10.58	\$ 9.82	
Part #	Description	1±	10±	25±	
A-2BB-EB	TWO HOUSING BB BRACKET; BLACK	\$26.92	\$25.12	\$23.33	
A-3BB-EB	THREE HOUSING BB BRACKET; BLACK	\$37.69	\$35.18	\$32.66	
Part #	Description	1±	100±	250±	500±
251031L0100SS	STAINLESS 5/16" X 1" LAG BOLT	\$0.47	\$0.45	\$0.42	\$0.39



PENTAIR® COMMERCIAL FILTER HOUSINGS



(156017-02)
Stainless Steel Housing

Stainless Steel Filter Housing

Part #	Description
156017-02	ST-1 FILTER 304 SS 3/4"FPT

CASE			
1±	2±	5±	10±
\$319.48	\$269.98	\$247.48	\$224.98

10" Bag Filter Housings

Part #	Description
150360	PBH-410-1" #10

CASE			
1±	2±	5±	10±
\$203.36	\$171.85	\$157.53	\$143.21

20" Bag Filter Housings

Part #	Description
150367	PBH-420-1" #20
150337	PBH-420-1-1/2" 20

CASE			
1±	2±	5±	10±
\$230.57	\$201.34	\$185.11	\$168.87
\$242.95	\$205.31	\$188.20	\$171.09



Bag Filter Housings
PBH Housings

Housings / Filters

QMP® HOUSINGS



QMP Filter Housings

Part #	Description
QMP300	10" F/H; WH/WH-F; 1/4"

CASE		
1±	12±	60±
\$17.42	\$16.25	\$15.09

Part #	Description
QMP300-BL/W	10" F/H; BL/WH-F; 1/4" (WHITE CAP)
QMP300-BL/BK	10" F/H; BL/BK-F; 1/4" (BLACK CAP)
QMP300-W/B	10" F/H; WH/BK-F; 1/4" (BLACK CAP)
QMP300-C	10" F/H; CHROME/BLACK-F; 1/4"
QMP3004-CR	10" F/H; LONG RIB CHROME/BK-F 1/4"
QMP300-3/4	10" F/H; WH/WH-F; 3/4" W/O PR

1±	12±	60±	120±
\$17.88	\$16.72	\$16.02	\$14.86
\$17.88	\$16.72	\$16.02	\$14.86
\$17.88	\$16.72	\$16.02	\$14.86
\$35.00	\$32.73	\$31.37	\$29.09
\$37.50	\$35.07	\$33.61	\$31.17
\$19.23	\$17.99	\$17.24	\$15.99

QMP Counter Top Filter Housing

Part #	Description
QMP300-CT	10" F/H; WH/WH-F; 1/4"; CT(LP)

CASE			
1±	12±	60±	120±
\$11.53	\$10.78	\$10.33	\$9.58

QMP Accessories

Part #	Description
QMP300WR	HOUSING WRENCH-WHITE
QMP300-O-RING	QMP300 O-RING

CASE			
1±	10±	50±	100±
\$2.72	\$2.55	\$2.44	\$2.26
\$0.90	\$0.84	\$0.81	\$0.75



(QMP300WR)



HARMSCO® STAINLESS STEEL FILTER HOUSINGS



Cartridge Cluster Filter Housings (HIF-7)



Cartridge Cluster Filter Housings (HIF-42)



Cartridge Cluster Filter Housings (HIF-200-FL)



Hurricane Single Filter Housings (HUR 40 HP)

Cartridge Cluster Filter Housings

Part #	Description	1±	2±	5±
HIF-7	7 FILTER; 30GPM; 1.5"	\$1,353.89	\$1,173.37	\$1,083.11
HIF-14	14 FILTER; 60GPM; 1.5"	\$1,919.93	\$1,663.94	\$1,535.94
HIF-21	21 FILTER; 90GPM; 1.5"	\$2,441.45	\$2,115.92	\$1,953.16
HIF-75	75 FILTER; 300GPM; 3"	\$8,190.09	\$7,098.08	\$6,552.08
HIF-16	16 FILTER; 75GPM; 2"	\$2,095.62	\$1,816.21	\$1,676.50
HIF-24	24 FILTER; 100GPM; 2"	\$2,614.76	\$2,266.13	\$2,091.81
HIF-42	42 FILTER; 175GPM; 2"	\$5,751.83	\$4,984.92	\$4,601.46
HIF-100	100 FILTER; 400GPM; 3"	\$10,282.53	\$8,911.53	\$8,226.03
HIF-150-FL	150 FILTER; 600GPM; 4" FLANGED	\$15,025.50	\$13,022.10	\$12,020.40
HIF-200-FL	200 FILTER; 800GPM; 4" FLANGED	\$17,676.03	\$15,319.23	\$14,140.83



Hurricane Single Filter Housings (HUR 90 HP)

Hurricane Single Filter Housings

Part #	Description	1±	2±	5±
HUR-40-HP	50 GPM; 2"	\$2,529.69	\$2,192.40	\$2,023.76
HUR-170-HP	200 GPM; 2"	\$4,529.91	\$3,925.93	\$3,623.93
HUR-90-HP	100 GPM; 2"	\$3,010.67	\$2,609.25	\$2,408.54



Hurricane Single Filter Housings (HUR 170 HP)

Waterbetter Single Filter Housings

Part #	Description	1±	2±	5±
WB-40-SC	50 GPM; 2"	\$1,267.23	\$1,098.27	\$1,013.79
WB-90-SC	100 GPM; 2"	\$1,834.07	\$1,589.53	\$1,467.26
WB-170-SC-2	150 GPM; 2"	\$2,615.55	\$2,266.81	\$2,092.44

Band Clamp Stainless Steel Housings

Part #	Description	1±	2±	5±
BC4-1-T-EP	25 GPM; 2" I/O	\$1,512.09	\$1,310.48	\$1,209.68
BC6-1-T-EP	42 GPM; 2" I/O	\$1,849.97	\$1,603.31	\$1,479.98
BC4-3-T-EP	75 GPM; 2" I/O	\$1,927.08	\$1,670.14	\$1,541.67
BC6-2-T-EP	84 GPM; 2" I/O	\$2,099.60	\$1,819.65	\$1,679.68
BC6-3-T-EP	126 GPM; 2" I/O	\$2,345.25	\$2,032.55	\$1,876.20

Part #	Description	1±	5±	10±
BC4-2-T-EP	50 GPM; 2" I/O	\$1,679.04	\$1,455.17	\$1,343.24

Hurricane Swing Bolt Stainless Steel Housings

Part #	Description	1±	2±	5±
HUR1X170FL-XP	150 GPM; 2" FLG	\$5,342.40	\$4,630.08	\$4,273.92



Band Clamp Stainless Steel Housings



Housings / Filters



HARMSCO® SEDIMENT FILTERS



SureSafe™ Anti-Microbial Cartridges

Harmsco® SureSafe™ cartridges utilize Silver Zeolite technology. Harmsco® SureSafe™ antimicrobial media is fabricated with the latest in Silver Zeolite technology. Unlike competitive “treated media” products, Harmsco® SureSafe™ antimicrobial cartridges will continue to provide safety and protection for your customers while outlasting the competition. Silver Zeolite technology has been effective against more than 650 strains of bacteria, fungi and molds in laboratory environments. It has completed FDA testing and is registered with the EPA.

10" x 2.75" SureSafe™ Anti-Microbial Cartridges

Part #	Description	1±	24±	120±
801-20-AM	20 MIC.	\$11.97	\$10.37	\$9.58
801-50-AM	50 MIC.	\$11.97	\$10.37	\$9.58

10" BB SureSafe™ Anti-Microbial Cartridges

Part #	Description	1±	8±	40±
HB-10-20W-AM	20 MIC.	\$30.53	\$26.46	\$24.43
HB-10-50W-AM	50 MIC.	\$30.53	\$26.46	\$24.43

20" BB SureSafe™ Anti-Microbial Cartridges

Part #	Description	1±	4±	20±
HB-20-20W-AM	20 MIC.	\$52.51	\$45.51	\$42.01
HB-20-50W-AM	50 MIC.	\$52.51	\$45.51	\$42.01

9.75" x 2.5" Single Length WaterBetter® Polyester Pleated Cartridges

Part #	Description	1±	24±	120±
WB-1-W	1 MIC.	\$10.74	\$9.31	\$8.59
WB-20-W	20 MIC.	\$9.62	\$8.34	\$7.70
WB-50-W	50 MIC.	\$9.62	\$8.34	\$7.70
WB-5-W	5 MIC.	\$9.62	\$8.34	\$7.70



Water Better Cartridges

19.5" x 2.5" WaterBetter® Polyester Pleated Cartridges

Part #	Description	1±	24±	120±
WB-921-1	1 MIC.	\$26.40	\$22.88	\$21.12
WB-921-5	5 MIC.	\$22.42	\$19.43	\$17.94
WB-921-20	20 MIC.	\$22.42	\$19.43	\$17.94
WB-921-50	50 MIC.	\$22.42	\$19.43	\$17.94

20" x 2.5" Double Length; WaterBetter® Polyester Pleated Cartridges

Part #	Description	1±	16±	80±
WB-20-1-W	1 MIC.	\$27.27	\$23.64	\$21.82
WB-20-5-W	5 MIC.	\$21.75	\$18.85	\$17.40
WB-20-20-W	20 MIC.	\$23.30	\$20.19	\$18.64
WB-20-50-W	50 MIC.	\$23.30	\$20.19	\$18.64

29.25" x 2.5" WaterBetter® Polyester Pleated Cartridges

Part #	Description	1±	24±	120±
WB-931-1	1 MIC.	\$34.63	\$30.01	\$27.70
WB-931-5	5 MIC.	\$32.76	\$28.39	\$26.21
WB-931-20	20 MIC.	\$32.76	\$28.39	\$26.21
WB-931-50	50 MIC.	\$32.76	\$28.39	\$26.21

10" x 4.5" [10"BB] WaterBetter® Polyester Pleated Cartridges

Part #	Description	1±	8±	40±
WB-HB-10-1-W	1 MIC.	\$25.29	\$21.92	\$20.23
WB-HB-10-5-W	5 MIC.	\$21.55	\$18.68	\$17.24
WB-HB-10-50-W	50 MIC.	\$21.55	\$18.68	\$17.24
WB-HB-10-20-W	20 MIC.	\$21.55	\$18.68	\$17.24

20" x 4.5" [20"BB] WaterBetter® Polyester Pleated Cartridges

Part #	Description	1±	4±	20±
WB-HB-20-1-W	1 MIC.	\$50.41	\$43.69	\$40.33
WB-HB-20-5-W	5 MIC.	\$42.93	\$37.21	\$34.35
WB-HB-20-20-W	20 MIC.	\$42.93	\$37.21	\$34.35
WB-HB-20-50-W	50 MIC.	\$42.93	\$37.21	\$34.35

Housings / Filters



Absolute Poly Pleated Cartridges

Absolute Polyester Pleated Cartridges

Part #	Description	1+	12+	60+
PP-975-0.2-DOE	9 3/4" ABSO .2M POLY FILTER;DOE	\$136.27	\$118.10	\$109.02
PP-20-0.2-DOE	20" .2M AB POLY FILTER; DOE	\$201.82	\$174.91	\$161.45

Poly-Pleat® 1 Micron Absolute Filter Cartridges

Part #	Description	1+	24+	120+
PP-S-1	2.75" X 9.75" (SINGLE) 1 MIC ABSOLUTE	\$31.13	\$26.98	\$24.90
PP-D-1	2.75" X 19.5" (DOUBLE) 1 MIC ABSOLUTE	\$62.05	\$53.78	\$49.64
PP-20E-1	2.75" X 20" 1 MIC ABSOLUTE	\$65.19	\$56.50	\$52.16
PP-T-1	2.75" X 29.25" (TRIPLE) 1 MIC ABSOLUTE	\$92.54	\$80.20	\$74.04

Part #	Description	1+	8+	40+
PP-BB-10-1	4.5" X 9.75" 1 MIC ABSOLUTE	\$71.83	\$62.26	\$57.47

Part #	Description	1+	4+	20+
PP-BB-20-1	4.5" X 20" 1 MIC ABSOLUTE	\$120.37	\$104.32	\$96.30

9.75" x 2.75" Polyester Pleated Cartridges (Individually Wrapped)

Part #	Description	1+	24+	120+
801-0.35-W	0.35 MIC.	\$20.13	\$17.44	\$16.10
801-5-W	5 MIC.	\$12.65	\$10.96	\$10.12
801-50-W	50 MIC.	\$12.65	\$10.96	\$10.12
801-1-W	1 MIC.	\$14.87	\$12.89	\$11.90
801-10-W	10 MIC.	\$12.65	\$10.96	\$10.12
801-20-W	20 MIC.	\$12.65	\$10.96	\$10.12
801-100-W	100 MIC.	\$12.65	\$10.96	\$10.12

9.75" x 2.75" High Temp. Polyester Pleated Cartridges - (Max 200°F)

Part #	Description	1+	24+	120+
801-1-HT	1 MIC.	\$15.67	\$13.58	\$12.53
801-5-HT	5 MIC.	\$13.48	\$11.68	\$10.79
801-20-HT	20 MIC.	\$13.48	\$11.68	\$10.79
801-50-HT	50 MIC.	\$13.48	\$11.68	\$10.79

19.5" x 2.75" Polyester Pleated Cartridges

Part #	Description	1+	24+	120+
921-0.35	0.35 MIC.	\$37.01	\$32.08	\$29.61
921-5	5 MIC.	\$24.49	\$21.23	\$19.59
921-10	10 MIC.	\$24.49	\$21.23	\$19.59
921-50	50 MIC.	\$24.49	\$21.23	\$19.59
921-1	1 MIC.	\$29.26	\$25.36	\$23.41
921-20	20 MIC.	\$24.49	\$21.23	\$19.59

20" x 2.75" Polyester Pleated Cartridges

Part #	Description	1+	24+	120+
801-0.35-20	0.35 MIC.	\$37.01	\$32.08	\$29.61
801-1-20	1 MIC.	\$29.26	\$25.36	\$23.41
801-5-20	5 MIC.	\$24.49	\$21.23	\$19.59
801-20-20	20 MIC.	\$24.49	\$21.23	\$19.59
801-50-20	50 MIC.	\$24.49	\$21.23	\$19.59

29.25" x 2.75" Polyester Pleated Cartridges

Part #	Description	1+	24+	120+
931-0.35	0.35 MIC.	\$64.16	\$55.61	\$51.33
931-1	1 MIC.	\$46.75	\$40.52	\$37.40
931-5	5 MIC.	\$44.76	\$38.80	\$35.81
931-10	10 MIC.	\$44.76	\$38.80	\$35.81
931-20	20 MIC.	\$44.76	\$38.80	\$35.81

30" x 2.75" Polyester Pleated Cartridges

Part #	Description	1+	24+	120+
801-0.35-30	0.35 MIC.	\$64.16	\$55.61	\$51.33
801-1-30	1 MIC.	\$46.75	\$40.52	\$37.40
801-5-30	5 MIC.	\$44.76	\$38.80	\$35.81
801-20-30	20 MIC.	\$44.76	\$38.80	\$35.81
801-50-30	50 MIC.	\$44.76	\$38.80	\$35.81

40" x 2.75" Polyester Pleated Cartridges

Part #	Description	1+	24+	120+
801-1-40	1 MIC.	\$58.40	\$50.61	\$46.72
801-5-40	5 MIC.	\$52.51	\$45.51	\$42.01



Poly Pleated Cartridges

Housings / Filters



Hurricane® Anti-Microbial Cartridge (HC-40-20-AM)



Hurricane Cartridges

10" BB Polyester Pleated Filter Cartridges

Part #	Description	1±	8±	40±
HB-10-0.35-W	0.35 MIC.	\$46.75	\$40.52	\$37.40
HB-10-1-W	1 MIC.	\$34.63	\$30.01	\$27.70
HB-10-5-W	5 MIC.	\$30.53	\$26.46	\$24.43
HB-10-20-W	20 MIC.	\$30.53	\$26.46	\$24.43
HB-10-50-W	50 MIC.	\$30.53	\$26.46	\$24.43

20" BB Polyester Pleated Filter Cartridges

Part #	Description	1±	4±	20±
HB-20-0.35-W	0.35 MIC.	\$75.85	\$65.74	\$60.88
HB-20-5-W	5 MIC.	\$52.51	\$45.51	\$42.01
HB-20-1-W	1 MIC.	\$61.30	\$53.13	\$49.04
HB-20-20-W	20 MIC.	\$52.51	\$45.51	\$42.01
HB-20-50-W	50 MIC.	\$52.51	\$45.51	\$42.01

Hurricane® Anti-Microbial Cartridges

Part #	Description	1±	2±	5±
HC-40-20-AM	20 MIC.	\$142.35	\$123.37	\$113.88
HC-40-50-AM	50 MIC.	\$142.35	\$123.37	\$113.88
HC-90-20-AM	20 MIC.	\$199.23	\$172.67	\$159.39
HC-90-50-AM	50 MIC.	\$199.23	\$172.67	\$159.39
HC-170-20-AM	20 MIC.	\$308.31	\$267.20	\$246.65
HC-170-50-AM	50 MIC.	\$308.31	\$267.20	\$246.65

Hurricane 40 HP Polyester Pleated Cartridges

Part #	Description	1±	2±	5±
HC-40-0.35	0.35 MIC.	\$173.99	\$150.79	\$139.19
HC-40-100	100 MIC.	\$142.35	\$123.37	\$113.88
HC-40-1	1 MIC.	\$155.03	\$134.36	\$124.02
HC-40-5	5 MIC.	\$142.35	\$123.37	\$113.88
HC-40-20	20 MIC.	\$142.35	\$123.37	\$113.88
HC-40-50	50 MIC.	\$142.35	\$123.37	\$113.88

Hurricane 90 HP Polyester Pleated Cartridges

Part #	Description	1±	2±	5±
HC-90-0.35	0.35 MIC.	\$245.10	\$212.42	\$196.08
HC-90-10	10 MIC.	\$199.23	\$172.67	\$159.39
HC-90-20	20 MIC.	\$199.23	\$172.67	\$159.39
HC-90-1	1 MIC.	\$216.64	\$187.76	\$173.31
HC-90-5	5 MIC.	\$199.23	\$172.67	\$159.39
HC-90-50	50 MIC.	\$199.23	\$172.67	\$159.39
HC-90-100	100 MIC.	\$199.23	\$172.67	\$159.39
HC-90-150	150 MIC.	\$199.23	\$172.67	\$159.39

Hurricane 170 HP Polyester Pleated Cartridges

Part #	Description	1±	2±	5±
HC-170-0.35	0.35 MIC.	\$379.38	\$328.80	\$303.50
HC-170-1	1 MIC.	\$339.95	\$294.62	\$271.96
HC-170-5	5 MIC.	\$308.31	\$267.20	\$246.65
HC-170-20	20 MIC.	\$308.31	\$267.20	\$246.65
HC-170-50	50 MIC.	\$308.31	\$267.20	\$246.65
HC-170-100	100 MIC.	\$308.31	\$267.20	\$246.65
HC-170-150	150 MIC.	\$308.31	\$267.20	\$246.65

Hurricane Absolute Polyester Pleated Cartridges

Part #	Description	1±	2±	5±
PP-HC-40-1	40 HP; 1 MIC.	\$270.98	\$234.85	\$216.79
PP-HC-90-1	90 HP; 1 MIC.	\$429.03	\$371.82	\$343.22
PP-HC-170-1	170 HP; 1 MIC.	\$662.40	\$574.08	\$529.92

Hurricane Activated Carbon Cartridges

Part #	Description	1±	2±	5±
HC-40-AC-5	HC-40; 5 MIC.	\$191.76	\$166.19	\$153.41
HC-90-AC-5	HC-90; 5 MIC.	\$305.44	\$264.72	\$244.36
HC-170-AC-5	HC-170; 5 MIC.	\$418.97	\$363.11	\$335.18

Activated Carbon Cartridges

Part #	Description	1±	24±	120±
HAC-20-W	20" 5 MIC.	\$46.63	\$40.41	\$37.31

Part #	Description	1±	8±	40±
HAC-BB-10-W	10"BB 5 MIC.	\$66.11	\$57.30	\$52.89



UNICEL® SEDIMENT FILTERS

Unicel®

FILTER CARTRIDGES



Unicel® Filters

2 3/4" x 9 3/4" Pleated Filters

Part #	Description	CASE		
		1±	24±	120±
T-1197-01-B	1 MIC. POLYESTER 4 SQ.FT.	\$10.72	\$10.01	\$9.29
T-0597-05-B	5 MIC. POLYESTER 4 SQ.FT.	\$6.56	\$6.13	\$5.69
T-0697-10-B	10 MIC. POLYPROPYLENE 4 SQ.FT.	\$5.70	\$5.32	\$4.94
T-0497-20-B	20 MIC. POLYPROPYLENE 4 SQ.FT.	\$5.11	\$4.77	\$4.43
T-0497-63-B	20 MIC. POLYPROPYLENE 6 SQ.FT.	\$6.28	\$5.86	\$5.44
T-0797-50-B	50 MIC. POLYESTER 4 SQ.FT.	\$4.13	\$3.86	\$3.58
T-0597-65-B	5 MIC. POLYESTER 6 SQ.FT.	\$8.14	\$7.60	\$7.05
T-0697-64-B	10 MIC. POLYPROPYLENE 6 SQ.FT.	\$7.31	\$6.82	\$6.34
T-0797-62-B	50 MIC. POLYPROPYLENE 6 SQ.FT.	\$5.70	\$5.32	\$4.94

2 3/4" x 20" Pleated Filters

Part #	Description	CASE		
		1±	20±	100±
T-1120-01-B	1 MIC. POLYESTER	\$23.30	\$21.75	\$20.19
T-0620-10-B	10 MIC. POLYPROPYLENE	\$11.42	\$10.66	\$9.90
T-0420-20-B	20 MIC. POLYPROPYLENE	\$9.87	\$9.21	\$8.56
T-0520-05-B	5 MIC. POLYESTER	\$12.46	\$11.63	\$10.80
T-0720-50-B	50 MIC. POLYESTER	\$8.14	\$7.60	\$7.05

4 5/8" x 9 3/4" BB Pleated Filters

Part #	Description	CASE		
		1±	8±	40±
K-41115-B	1 MIC. POLYESTER	\$32.33	\$30.17	\$28.02
K-40515-B	5 MIC. POLYESTER	\$20.44	\$19.07	\$17.71
K-40415-B	20 MIC. POLYPROPYLENE	\$16.08	\$15.01	\$13.94
K-40615-B	10 MIC. POLYPROPYLENE	\$18.74	\$17.49	\$16.24
K-40715-B	50 MIC. POLYESTER	\$13.73	\$12.82	\$11.90

4 5/8" x 20" BB Pleated Filters

Part #	Description	CASE		
		1±	4±	20±
K-41130-B	1 MIC. POLYESTER	\$56.58	\$52.81	\$49.03
K-40530-B	5 MIC. POLYESTER	\$34.36	\$32.07	\$29.78
K-40430-B	20 MIC. POLYPROPYLENE	\$24.08	\$22.47	\$20.87
K-40730-B	50 MIC. POLYESTER	\$21.34	\$19.92	\$18.50
K-40630-B	10 MIC. POLYPROPYLENE	\$29.32	\$27.37	\$25.42

UNITED SEDIMENT FILTERS



Depth Wound Polypropylene Filter

2.5" x 10" Depth Wound Polypropylene

Part #	Description	CASE		
		1±	30±	150±
UP.5R10P	0.5 MIC.	\$5.63	\$5.25	\$4.88
UP1R10P	1 MIC.	\$4.25	\$3.97	\$3.68
UP3R10P	3 MIC.	\$4.25	\$3.97	\$3.68
UP5R10P	5 MIC.	\$4.25	\$3.97	\$3.68
UP10R10P	10 MIC.	\$4.25	\$3.97	\$3.68
UP20R10P	20 MIC.	\$4.25	\$3.97	\$3.68
UP25R10P	25 MIC.	\$4.25	\$3.97	\$3.68
UP30R10P	30 MIC.	\$4.25	\$3.97	\$3.68
UP50R10P	50 MIC.	\$4.25	\$3.97	\$3.68
UP100R10P	100 MIC.	\$4.15	\$3.87	\$3.59

2.5" x 20" Depth Wound Polypropylene

Part #	Description	CASE		
		1±	15±	75±
UP1R20P	1 MIC.	\$7.80	\$7.28	\$6.76
UP5R20P	5 MIC.	\$7.80	\$7.28	\$6.76
UP10R20P	10 MIC.	\$7.80	\$7.28	\$6.76
UP30R20P	30 MIC.	\$7.38	\$6.89	\$6.40
UP20R20P	20 MIC.	\$7.80	\$7.28	\$6.76

4.5" x 10" BB Depth Wound Polypropylene

Part #	Description	CASE		
		1±	12±	60±
UP0.5J10P	0.5 MIC.	\$15.38	\$14.36	\$13.33
UP1J10P	1 MIC.	\$14.20	\$13.25	\$12.30
UP5J10P	5 MIC.	\$14.20	\$13.25	\$12.30
UP20J10P	20 MIC.	\$14.20	\$13.25	\$12.30
UP3J10P	3 MIC.	\$13.94	\$13.01	\$12.08
UP10J10P	10 MIC.	\$14.20	\$13.25	\$12.30
UP30J10P	30 MIC.	\$14.20	\$13.25	\$12.30



Depth Wound Polypropylene Filter

4.5" x 20" BB Depth Wound Polypropylene

Part #	Description	CASE		
		1+	6+	30+
UP1J20P	1 MIC.	\$26.48	\$24.71	\$22.95
UP5J20P	5 MIC.	\$26.48	\$24.71	\$22.95
UP20J20P	20 MIC.	\$26.48	\$24.71	\$22.95
UP10J20P	10 MIC.	\$26.48	\$24.71	\$22.95
UP30J20P	30 MIC.	\$26.06	\$24.32	\$22.58

2.5 x 10" Pleated Polyester

Part #	Description	CASE		
		1+	25+	125+
PE1X934	1 MIC.	\$8.90	\$8.31	\$7.71
PE50X934	50 MIC.	\$8.63	\$8.06	\$7.48
PE100X934	100 MIC.	\$8.63	\$8.06	\$7.48
PE5X934	5 MIC.	\$8.54	\$7.97	\$7.40
PE20X934	20 MIC.	\$8.99	\$8.39	\$7.79

2.5" x 20" Pleated Polyester

Part #	Description	CASE		
		1+	20+	100+
PE5X20	5 MIC.	\$11.91	\$11.12	\$10.33
PE20X20	20 MIC.	\$10.98	\$10.25	\$9.52
PE50X20	50 MIC.	\$11.05	\$10.31	\$9.58
PE10X20	10 MIC.	\$10.93	\$10.20	\$9.47
PE100X20	100 MIC.	\$11.05	\$10.31	\$9.58



Pleated Polyester

4.5" x 10" BB Pleated Polyester

Part #	Description	CASE		
		1+	12+	60+
PE1X93/4BB	1 MIC.	\$13.88	\$12.95	\$12.03
PE100X10BB	100 MIC.	\$12.15	\$11.34	\$10.53
PE5X93/4BB	5 MIC.	\$13.23	\$12.35	\$11.47
PE20X93/4BB	20 MIC.	\$11.71	\$10.93	\$10.15
PE50X934BB	50 MIC.	\$14.09	\$13.15	\$12.21
PE10X93/4BB	10 MIC.	\$12.38	\$11.56	\$10.73

4.5" x 20" BB Pleated Polyester

Part #	Description	CASE		
		1+	6+	30+
PE1X20BB	1MIC.	\$17.88	\$16.69	\$15.50
PE5X20BB	5 MIC.	\$18.63	\$17.39	\$16.15
PE10X20BB	10 MIC.	\$16.78	\$15.66	\$14.54
PE20X20BB	20 MIC.	\$17.57	\$16.40	\$15.23
PE50X20BB	50 MIC.	\$20.79	\$19.41	\$18.02
PE100X20BB	100 MIC.	\$18.86	\$17.61	\$16.35



Powdered Carbon Impregnated Cellulose

1 Micron Absolute Pleated

Part #	Description	CASE		
		1+	25+	125+
PP1X10(ABS)	10" 1M ABSOLUTE; POLY	\$26.24	\$24.49	\$22.74
PP1X10BB(ABS)	10" BB 1M ABSOLUTE; POLY	\$23.36	\$21.80	\$20.25
PP1X20BB(ABS)	20" BB 1M ABSOLUTE; POLY	\$36.92	\$34.46	\$32.00

Powdered Carbon Impregnated Cellulose

Powdered Carbon Impregnated Cellulose		CASE		
Part #	Description	1+	24+	120+
UPAMC1	2.5" x 10" CARBON IMP CELL-IND. 5MIC	\$11.96	\$11.16	\$10.37
UPAMC2	2.5" x 20" CARBON IMP CELL-IND. 5 MIC	\$26.48	\$24.71	\$22.95
UPAMC1BB	4.5" x 10" BB CARBON IMP CELL 5 MIC	\$39.18	\$36.57	\$33.96
UPAMC2BB	4.5" x 20" BB CARBON IMP CELL 5 MIC	\$62.22	\$58.07	\$53.93

Housings / Filters



DUAL MICRON POLY SPUN SEDIMENT FILTERS



Large Diameter Filters

10" x 4.5" [10"BB] Dual Micron Poly Sediment Filter

Part #	Description	1±	10±	50±
3015155	MMB-7525-10 ; 10"BB	\$10.60	\$9.94	\$9.28
3015157	MMB-5005-10 ; 10"BB	\$9.49	\$8.90	\$8.31
3015159	MMB-2501-10 ; 10"BB	\$12.38	\$11.60	\$10.83

20" x 4.5" [20"BB] Dual Micron Poly Sediment Filter

Part #	Description	1±	5±	25±
3015156	MMB-7525-20 ; 20"BB	\$19.93	\$18.69	\$17.44
3015158	MMB-5005-20 ; 20"BB	\$19.54	\$18.32	\$17.10
3015160	MMB-2501-20 ; 20"BB	\$21.19	\$19.86	\$18.54

Housings / Filters

VALUTREX™ SEDIMENT FILTERS



Valutrex™ Poly Spun Sediment Filters 9 3/4" x 2.5"

Part #	Description	1±	40±	400±	1440±
1227865-V	VX01-9 7/8" 1M SED CARTRIDGE	\$1.21	\$1.17	\$1.13	\$1.05
1227867-V	VX05-9 7/8" 5M SED CARTRIDGE	\$1.21	\$1.17	\$1.13	\$1.05
1227869-V	VX10-9 7/8" 10M SED CARTRIDGE	\$2.42	\$2.33	\$2.26	\$2.10
1227871-V	VX25-9 7/8" 25M SED CARTRIDGE	\$1.21	\$1.17	\$1.13	\$1.05

Valutrex™ Poly Spun Sediment Filters 20" x 2.5"

Part #	Description	1±	20±	200±	720±
1227866-V	VX01-20" 1M SED CARTRIDGE	\$4.90	\$4.71	\$4.58	\$4.25
1227868-V	VX05-20" 5M SED CARTRIDGE	\$4.90	\$4.71	\$4.58	\$4.25
1227870-V	VX10-20" 10M SED CARTRIDGE	\$4.90	\$4.71	\$4.58	\$4.25
1227872-V	VX25-20" 25M SED CARTRIDGE	\$4.90	\$4.71	\$4.58	\$4.25

Valutrex™ Poly Spun Sediment Filters 10" x 4.5" [10"BB]

Part #	Description	1±	12±	120±	300±
1227865-V-BB	VX01-10" BB 1M SED CARTRIDGE	\$13.60	\$13.06	\$12.69	\$11.79
1227867-V-BB	VX05-10" BB 5M SED CARTRIDGE	\$13.60	\$13.06	\$12.69	\$11.79
1227869-V-BB	VX10-10" BB 10M SED CARTRIDGE	\$13.60	\$13.06	\$12.69	\$11.79
1227871-V-BB	VX25-10" BB 25M SED CARTRIDGE	\$6.80	\$6.53	\$6.35	\$5.90

Valutrex™ Poly Spun Sediment Filters 20" x 4.5" [20"BB]

Part #	Description	1±	6±	60±	150±
1227866-V-BB	VX01-20"BB 1M SED CARTRIDGE	\$13.59	\$13.04	\$12.68	\$11.78
1227868-V-BB	VX05-20"BB 5M SED CARTRIDGE	\$13.59	\$13.04	\$12.68	\$11.78
1227870-V-BB	VX10-20" BB 10M SED CARTRIDGE	\$27.17	\$26.08	\$25.36	\$23.55
1227872-V-BB	VX25-20" BB 25M SED CARTRIDGE	\$27.17	\$26.08	\$25.36	\$23.55



Poly Spun Sediment Filters



PURTEX™ SEDIMENT FILTERS



Purtrex™ Depth Filters

Purtrex depth filters are an exceptional value for general applications where long life, high purity and low change-out frequency are required. Produced through VEOLIA's patented melt blown micro-fiber technology, Purtrex is a 100% pure polypropylene depth filter with exceptional dirt-holding capacity.



Purtrex 2.5" x 4 7/8" Depth Filters

Part #	Description	1±	80±	400±
93174	PX01-4 7/8 1 MIC.	\$4.38	\$4.09	\$3.91
93007	PX05-4 7/8 5 MIC.	\$4.77	\$4.46	\$4.27
93005	PX20-4 7/8 20 MIC.	\$4.38	\$4.09	\$3.91
93177	PX75-4 7/8 75 MIC.	\$4.38	\$4.09	\$3.91

Purtrex 2.5" x 9 7/8" Depth Filters

Part #	Description	1±	40±	200±
93113	PX01-9 7/8 1 MIC.	\$2.72	\$2.54	\$2.43
93023	PX05-9 7/8 5 MIC.	\$2.48	\$2.31	\$2.21
93021	PX20-9 7/8 20 MIC.	\$2.02	\$1.88	\$1.80
93020	PX30-9 7/8 30 MIC.	\$1.97	\$1.84	\$1.76
93111	PX50-9 7/8 50 MIC.	\$1.91	\$1.78	\$1.70
93110	PX75-9 7/8 75 MIC.	\$1.81	\$1.69	\$1.62
93112	PX03-9 7/8 3 MIC.	\$2.86	\$2.67	\$2.55
93022	PX10-9 7/8 10 MIC.	\$2.08	\$1.94	\$1.86

Purtrex 2.5" x 20" Depth Filters

Part #	Description	1±	20±	100±
93125	PX01-20 1 MIC.	\$4.72	\$4.41	\$4.22
93047	PX05-20 5 MIC.	\$4.38	\$4.09	\$3.91
93046	PX10-20 10 MIC.	\$4.33	\$4.04	\$3.87
93045	PX20-20 20 MIC.	\$4.22	\$3.94	\$3.77
93044	PX30-20 30 MIC.	\$3.91	\$3.65	\$3.49
93122	PX75-20 75 MIC.	\$3.64	\$3.40	\$3.25
93124	PX03-20 3 MIC.	\$4.81	\$4.49	\$4.30
93123	PX50-20 50 MIC.	\$3.74	\$3.49	\$3.34

Purtrex 2.5" x 29 1/4" Depth Filters

Part #	Description	1±	20±	100±
93133	PX01-29 1/4 1 MIC.	\$7.44	\$6.94	\$6.65
93053	PX20-29 1/4 20 MIC.	\$6.31	\$5.89	\$5.64
93132	PX03-29 1/4 3 MIC.	\$7.66	\$7.15	\$6.84
93055	PX05-29 1/4 5 MIC.	\$6.98	\$6.51	\$6.23
93054	PX10-29 1/4 10 MIC.	\$6.44	\$6.01	\$5.75
93131	PX50-29 1/4 50 MIC.	\$5.57	\$5.20	\$4.98

Purtrex 2.5" x 30" Depth Filters

Part #	Description	1±	20±	100±
93205	PX01-30 1 MIC.	\$6.40	\$5.97	\$5.71
93136	PX03-30 3 MIC.	\$7.44	\$6.94	\$6.65
93056	PX30-30 30 MIC.	\$5.82	\$5.44	\$5.20
93135	PX50-30 50 MIC.	\$5.43	\$5.07	\$4.86
93207	PX05-30 5 MIC.	\$5.94	\$5.54	\$5.30
93058	PX10-30 10 MIC.	\$6.31	\$5.89	\$5.64
93057	PX20-30 20 MIC.	\$6.31	\$5.89	\$5.64

Purtrex 2.5" x 40" Depth Filters

Part #	Description	1±	20±	100±
93141	PX01-40 1 MIC.	\$8.44	\$7.88	\$7.54
93140	PX03-40 3 MIC.	\$9.53	\$8.89	\$8.51
93063	PX05-40 5 MIC.	\$7.75	\$7.23	\$6.92
93062	PX10-40 10 MIC.	\$7.67	\$7.16	\$6.85
93061	PX20-40 20 MIC.	\$8.09	\$7.55	\$7.23
93060	PX30-40 30 MIC.	\$7.77	\$7.25	\$6.94
93139	PX50-40 50 MIC.	\$7.44	\$6.94	\$6.65

Purtrex 2.5" x 50" Depth Filters

Part #	Description	1±	20±	100±
93184	PX50-50 50 MIC.	\$13.75	\$12.83	\$12.28
93185	PX03-50 3 MIC.	\$16.34	\$15.25	\$14.60
Part #	Description	1±	20±	200±
93186	PX01-50 1 MIC.	\$18.06	\$16.86	\$16.13
93067	PX05-50 5 MIC.	\$14.97	\$13.98	\$13.38

Housings / Filters



HYTREX™ SEDIMENT FILTERS



Hytrex™ Filters

The purity and reliability of Hytrex™ cartridge filters ensure consistent results, time after time. Thermally bonded micro fibers create a strong secure cartridge that traps particles throughout its depth. Hytrex™ combines efficiency, long life and purity to create a high performance depth filter.



Hytrex™ Filters

Hytrex 2.5" x 4 7/8" Sediment Cartridges

Part #	Description	1+	80+	400+
94566	GX01-4 7/8 1 MIC.	\$4.72	\$4.41	\$4.22
94516	GX05-4 7/8 5 MIC.	\$5.57	\$5.20	\$4.98
94579	GX03-4 7/8 3 MIC.	\$4.82	\$4.50	\$4.31
94556	GX10-4 7/8 10 MIC.	\$4.46	\$4.16	\$3.98
94526	GX20-4 7/8 20 MIC.	\$4.77	\$4.46	\$4.27
94597	GX30-4 7/8 30 MIC.	\$4.77	\$4.46	\$4.27

Hytrex 2.5" x 9 7/8" Sediment Cartridges

Part #	Description	1+	40+	200+
94766	GX01-9 7/8 1 MIC.	\$3.81	\$3.56	\$3.41
94767	GX03-9 7/8 3 MIC.	\$3.78	\$3.53	\$3.38
94587	GX05-9 7/8 5 MIC.	\$3.42	\$3.19	\$3.05
94765	GX10-9 7/8 10 MIC.	\$3.21	\$3.00	\$2.87
94762	GX20-9 7/8 20 MIC.	\$3.21	\$3.00	\$2.87
94768	GX30-9 7/8 30 MIC.	\$3.18	\$2.97	\$2.84
94763	GX50-9 7/8 50 MIC.	\$3.15	\$2.94	\$2.81
94764	GX75-9 7/8 75 MIC.	\$2.89	\$2.70	\$2.58

Hytrex 2.5" x 20" Sediment Cartridges

Part #	Description	1+	20+	100+
94262	GX01-20 1 MIC.	\$7.51	\$7.01	\$6.71
94272	GX03-20 3 MIC.	\$7.31	\$6.82	\$6.53
94282	GX05-20 5 MIC.	\$7.00	\$6.53	\$6.25
94252	GX10-20 10 MIC.	\$6.75	\$6.30	\$6.03
94222	GX20-20 20 MIC.	\$6.41	\$5.99	\$5.73
94292	GX30-20 30 MIC.	\$6.13	\$5.73	\$5.48
94232	GX50-20 50 MIC.	\$6.03	\$5.63	\$5.39
94242	GX75-20 75 MIC.	\$5.57	\$5.20	\$4.98

Hytrex 2.5" x 29 1/4" Sediment Cartridges

Part #	Description	1+	20+	100+
94265	GX01-29 1/4 1 MIC.	\$11.25	\$10.50	\$10.05
94225	GX20-29 1/4 20 MIC.	\$9.54	\$8.90	\$8.52
94235	GX50-29 1/4 50 MIC.	\$9.09	\$8.49	\$8.12

Hytrex 2.5" x 30" Sediment Cartridges

Part #	Description	1+	20+	100+
94263	GX01-30 1 MIC.	\$11.25	\$10.50	\$10.05
94283	GX05-30 5 MIC.	\$10.32	\$9.63	\$9.22
94223	GX20-30 20 MIC.	\$10.70	\$10.07	\$9.44
94273	GX03-30 3 MIC.	\$11.04	\$10.30	\$9.86
94243	GX75-30 75 MIC.	\$8.42	\$7.86	\$7.52
94253	GX10-30 10 MIC.	\$9.78	\$9.12	\$8.73

Hytrex 2.5" x 40" Sediment Cartridges

Part #	Description	1+	20+	100+
94064	GX01-40 1 MIC.	\$15.18	\$14.17	\$13.56
94054	GX10-40 10 MIC.	\$13.46	\$12.57	\$12.03
94084	GX05-40 5 MIC.	\$14.24	\$13.29	\$12.72
94024	GX20-40 20 MIC.	\$13.07	\$12.20	\$11.68

Hytrex 2.5" x 50" Sediment Cartridges

Part #	Description	1+	20+	100+
94580	GX05-50 5 MIC.	\$17.86	\$16.67	\$15.96
94550	GX10-50 10 MIC.	\$16.89	\$15.77	\$15.09



PENTAIR® SEDIMENT FILTERS



PENTEK

S-1 Pleated Cellulose
(155001-43)



9-7/8" P5 Spun
Polypropylene
(155014-43)

20" P5 Spun
Polypropylene
(155016-43)



R50-BB
10" Cartridges
(155053-43)



DGD-2501
10" Cartridges
(155359-43)

20" Bag Filter
(155384-03)



2.5" x 10" Standard Sediment Filters

Part #	Description	1±	24±	120±	240±
155001-43	S-1; 20 MIC. PLEATED CELLULOSE	\$5.64	\$4.76	\$4.37	\$3.97
155017-43	R30; 30 MIC. PLEATED POLY REUSABLE	\$11.32	\$9.56	\$8.77	\$7.97
155038-43	R50; 50 MIC. PLEATED POLY REUSABLE	\$11.00	\$9.30	\$8.52	\$7.75
255482-43	ECP5-10 PLEATED 5 MICRON	\$8.10	\$6.84	\$6.27	\$5.70
255483-43	ECP20-10 PLEATED 20 MICRON	\$8.40	\$7.10	\$6.51	\$5.91
255484-43	ECP50-10 PLEATED 50 MICRON	\$8.67	\$7.33	\$6.72	\$6.11
155225-43	P1; 1 MIC. SPUN POLYPROPYLENE	\$6.00	\$5.07	\$4.65	\$4.40
155014-43	P5; 5 MIC. SPUN POLYPROPYLENE	\$5.05	\$4.27	\$3.92	\$3.56
155015-43	P25; 25 MIC. SPUN POLYPROPYLENE	\$5.31	\$4.49	\$4.11	\$3.74

10" x 2.5" High-Efficiency Polypropylene

20"x 2.5" Standard Sediment Filters

Part #	Description	1±	14±	70±	140±
155416-43	R30-20; 30 MIC. PLEATED POLY. REUSABLE	\$23.21	\$19.62	\$17.98	\$16.35
255486-43	ECP5-20 PLEATED 5 MICRON	\$17.37	\$14.68	\$13.46	\$12.23
255487-43	ECP20-20 PLEATED 20 MICRON	\$15.94	\$13.47	\$12.35	\$11.22

Part #	Description	1±	20±	100±	200±
155304-43	P1-20 SPUN POLYPROPYLENE	\$12.19	\$10.30	\$9.44	\$8.58
155016-43	P5-20; 5 MIC. SPUN POLYPROPYLENE	\$10.11	\$8.54	\$7.83	\$7.12
155226-43	P25-20; 25 MIC. SPUN POLYPROPYLENE	\$9.99	\$8.45	\$7.74	\$7.04

20" x 2.5" High-Efficiency Polypropylene

Part #	Description	1±	12±	60±	120±
PO.2-20E	0.2 MIC. PLEATED POLYPROPYLENE DOE	\$189.57	\$160.20	\$146.85	\$133.50

10" Big Blue® Sediment Cartridges

Part #	Description	1±	8±	40±	80±
155101-43	R30-BB; 30 MIC. PLEATED POLY REUSABLE	\$22.77	\$19.24	\$17.64	\$16.03
155053-43	R50-BB; 50 MIC. PLEATED POLY REUSABLE	\$18.22	\$15.40	\$14.12	\$12.83
255490-43	ECP5-10 BB PLEATED 5 MICRON	\$19.36	\$16.36	\$15.00	\$13.63
255491-43	ECP20-10 BB PLEATED 20 MICRON	\$19.65	\$16.61	\$15.22	\$13.84
255492-43	ECP50-10 BB PLEATED 50 MICRON	\$22.24	\$18.79	\$17.23	\$15.66
155359-43	DGD-2501; 25/1 MIC. DUAL GRADE POLY.	\$18.27	\$15.44	\$14.16	\$13.38
155357-43	DGD-5005; 50/5 MIC. DUAL GRADIENT POLY.	\$17.51	\$14.79	\$13.56	\$12.33
155355-43	DGD-7525; 75/25 MIC. DUAL GRADIENT POLY.	\$17.69	\$14.95	\$13.71	\$12.46
355221-43	100 MIC. WOUND FIBRILLATED POLY.	\$30.75	\$25.98	\$23.82	\$21.65

20" Big Blue® Sediment Cartridges

Part #	Description	1±	6±	30±	60±
155430-43	R30-20BB; 30 MIC. PLEATED POLY. REUSABLE	\$45.14	\$38.15	\$34.97	\$31.79
255494-43	ECP5-20 BB PLEATED 5 MICRON	\$36.15	\$30.55	\$28.01	\$25.46
255495-43	ECP20-20 BB PLEATED 20 MICRON	\$34.77	\$29.38	\$26.93	\$24.48
255496-43	ECP50-20 BB PLEATED 50 MICRON	\$40.53	\$34.25	\$31.40	\$28.54
155360-43	DGD-2501; 25/1 MIC. DUAL GRADE POLY.	\$33.68	\$28.46	\$26.09	\$23.72
155358-43	DGD-5005; 50/5 MIC. DUAL GRADE POLY.	\$32.32	\$27.32	\$25.04	\$23.68
155356-43	DGD-7525-20"BB DUAL GRADIENT POLY	\$32.17	\$27.18	\$24.92	\$22.65

20" BAG Filters

Part #	Description	1±	20±	100±	200±
155384-03	BP-420-1; 1 MIC.	\$7.79	\$6.59	\$6.04	\$5.49
155386-03	BP-420-5; 5 MIC.	\$7.36	\$6.22	\$5.70	\$5.18
155388-03	BP-420-10; 10 MIC.	\$7.79	\$6.59	\$6.04	\$5.49
155390-03	BP-420-25; 25 MIC.	\$7.79	\$6.59	\$6.04	\$5.49
155392-03	BP-420-50; 50 MIC.	\$7.79	\$6.59	\$6.04	\$5.49

Housings / Filters



PENTAIR® CARBON FILTERS



PENTEK

Diamond Flow
Sediment / Carbon
(655130-43)



9-3/4" GAC-10
GAC Cartridge
(155109-43)

4-7/8" x 2.5" Standard Carbon Taste & Odor

Part #	Description	1±	24±	120±	240±
155022-43	C2; 5 MIC. ACT. CARBON IMP. CELL.	\$9.32	\$7.88	\$7.22	\$6.56

10" x 2.5" Diamond Flow - Dual Purpose Sediment/Carbon Filter

Part #	Description	1±	12±	60±	120±
655130-43	DFX-CB-10; 10 MIC; POLY/CARBON	\$8.68	\$7.34	\$6.73	\$6.11

9-3/4" x 2.5" Standard Carbon Taste & Odor

Part #	Description	1±	12±	60±	120±
155109-43	GAC-10; GRANULAR ACTIVATED CARBON	\$15.31	\$12.93	\$11.86	\$10.78
155155-43	CC-10; GRANULAR ACTIVATED CARBON	\$17.17	\$14.51	\$13.30	\$12.58
155634-43	EPM-10 CARBON BLOCK; 10 MICRON	\$10.03	\$8.48	\$7.77	\$7.06
155531-43	EP-10 CARBON BLOCK; 5 MICRON	\$12.58	\$10.63	\$9.75	\$8.86
155162-43	CBC-10; 0.5 MIC. CARBON BRIQUETTE	\$22.02	\$18.61	\$17.06	\$15.51
155350-43	SCBC-10; 0.5 MIC. SILVER IMPREG. CARBON	\$40.72	\$34.41	\$31.54	\$28.67

Part #	Description	1±	24±	120±	240±
155002-43	C1; 5 MIC. ACT. CARBON IMPREG. CELLULOSE	\$10.21	\$8.63	\$7.91	\$7.19

20" x 2.5" Diamond Flow - Dual Purpose Sediment/Carbon Filter

Part #	Description	1±	6±	30±	60±
655148-43	DFX-CB-20; 10 MIC; POLY/CARBON	\$14.06	\$11.88	\$10.89	\$9.90

20" x 2.5" Standard Carbon Taste & Odor

Part #	Description	1±	14±	70±	140±
155597-43	C1-20; 5 MIC. ACT CARBON IMPREG. CELLULOSE	\$20.10	\$16.98	\$15.57	\$14.15
Part #	Description	1±	6±	30±	60±
155111-43	GAC-20; GRANULAR ACTIVATED CARBON	\$33.61	\$28.40	\$26.04	\$23.67
155065-43	RFC-20 RADIAL FLOW CARBON	\$49.91	\$42.78	\$39.21	\$35.65
155635-43	EPM-20 CARBON BLOCK; 10 MICRON	\$21.51	\$18.18	\$16.66	\$15.15
155529-43	EP-20 CARBON BLOCK; 5 MICRON	\$25.08	\$21.20	\$19.43	\$17.66

Part #	Description	1±	12±	60±	120±
155309-43	CBC-20; 0.5 MIC. CARBON BRIQUETTE	\$45.73	\$38.64	\$35.42	\$32.20

10" Big Blue® Carbon Taste & Odor

Part #	Description	1±	4±	20±	40±
155782-43	EPM-BB CARBON BLOCK; 10 MICRON	\$42.14	\$35.61	\$32.65	\$29.68
155548-43	EP-BB CARBON BLOCK; 5 MICRON	\$44.96	\$37.99	\$34.83	\$31.66
155170-43	CBC-BB; 0.5 MIC. CARBON BRIQUETTE	\$73.61	\$62.21	\$57.02	\$51.84

Part #	Description	1±	8±	40±	80±
155141-43	RFC-BB; RADIAL FLOW CARBON	\$56.73	\$47.94	\$43.95	\$39.95
155153-43	GAC-BB; GAC CARTRIDGE	\$39.54	\$33.41	\$30.63	\$27.84
155398-43	NCP-BB; 10 MIC. CARBON IMP. POLY PLTD.	\$30.12	\$25.46	\$23.34	\$21.21

20" Big Blue® Carbon Taste & Odor

Part #	Description	1±	6±	30±	60±
155247-43	RFC-20-BB; RADIAL FLOW CARBON	\$112.80	\$95.32	\$87.38	\$79.43
155382-43	NCP-20BB; 10 MIC. CARBON-IMP. POLY PLTD.	\$58.76	\$49.65	\$45.52	\$41.38
155651-43	C1-20BB; 5 MIC. CARBON IMP. CELL.	\$55.14	\$46.60	\$42.72	\$38.83

Part #	Description	1±	4±	20±	40±
155249-43	GAC20-BB; GAC CARTRIDGE	\$85.02	\$71.85	\$65.86	\$59.87
155783-43	EPM-20BB; 10 MIC. CARBON BRIQUETTE	\$77.40	\$65.41	\$59.96	\$54.51
155583-43	EP-20BB; 5 MIC. CARBON BRIQUETTE	\$86.00	\$72.68	\$66.62	\$60.56
155312-43	CBC-20BB; 0.5 MIC. CARBON BRIQUETTE	\$128.22	\$108.35	\$99.32	\$90.29

10" CBC-BB
Big Blue®
Carbon Briquette
(155170-43)



20" RFC20-BB
Big Blue®
Radial Flow Carbon
(155247-43)

Housings / Filters



VALUTREX™ CARBON BLOCK FILTERS



Valutrex™ carbon block filters are suitable for a wide range of Point of Use (POU), Point of Entry (POE), commercial and industrial applications.

Valutrex™ carbon block filters are made from 100% coconut shell carbon, a renewable, ecologically sustainable material. The carbon is processed into blocks using a unique binder system and proprietary manufacturing techniques to produce filters with a greater number of micro-pores, which display superior adsorption capacity and kinetic dynamics

Features

- 5 micron nominal filtration
- Exceptionally low pressure drop
- High dirt holding capacity

Valutrex™ Carbon Block Filters

Part #	Description	CASE			
		1±	25±	125±	250±
05-250-10-VX	VALUTREX 10" 5M CB FILTER	\$2.61	\$2.25	\$2.12	\$2.02
05-250-20-VX	VALUTREX 20" 5M CB FILTER	\$5.76	\$4.97	\$4.68	\$4.47
Part #	Description	1±	6±	30±	60±
05-450-10-VX	VALUTREX 10"BB 5M CB FILTER	\$10.36	\$8.94	\$8.42	\$8.03
Part #	Description	1±	4±	20±	40±
05-450-20-VX	VALUTREX 20"BB 5M CB FILTER	\$18.30	\$15.79	\$14.87	\$14.19

PART#	OD x Length	Micron Rating (nominal)*	Chlorine Capacity *
05-250-10-VX	2 ¾ " x 9 ¾ "(70mm x 248mm)	5	3,000 gallons @ 1 gpm 11,350 liters @ 3.8l/min
05-250-20-VX	2 ¾ " x 20 "(70mm x 508mm)	5	6,000 gallons @ 2 gpm 22,700 liters @ 7.6l/min
05-450-10-VX	4 ½ " x 9 ¾ "(114mm x 248mm)	5	9,600 gallons @ 3 gpm 36,300 liters @ 11.4l/min
05-450-20-VX	4 ½ " x 20 "(114mm x 508mm)	5	18,000 gallons @ 7gpm 68,100 liters @ 26.6l/min

* Performance claims are based on manufacturer's internal test data. Actual performance is dependent on influent water quality, flow rates, system design and application. Results may vary. Micron ratings are based on >85% removal of the given particle size.

Housings / Filters



KX® MATRIKX® CARBON FILTERS



INTRODUCING THE INDUSTRY'S FIRST AND ONLY FULL LINE OF ACTIVATED CARBON BLOCKS WITH ENHANCED PFAS & CHLORAMINE CLAIMS.

Matrikx® revolutionized water filtration when it launched its first activated carbon block in 1996. In the decades since, has earned a reputation for innovation. Our latest breakthrough is high performance catalytic carbon technology. is proud to announce the addition of PFAS & Chloramine reduction claims across our standard range of New and Improved carbon blocks.



CTO

Matrikx® CTO - 5 Micron - Chlorine/Chloramine Taste and Odor

Part #	Description	CASE			
		1±	20±	100±	200±
32-250-10-MATRIKX(R)	10" x 2.5"	\$3.77	\$3.25	\$3.06	\$2.92
32-250-20-MATRIKX(R)	20" x 2.5"	\$13.23	\$11.41	\$10.75	\$10.25
Part #	Description	1±	6±	30±	60±
32-450-10-MATRIKX(R)	10" x 4.5"	\$17.08	\$14.74	\$13.88	\$13.24
Part #	Description	1±	4±	20±	40±
32-450-20-MATRIKX(R)	20" x 4.5"	\$34.04	\$29.36	\$27.65	\$26.38



CTO Plus

Matrikx® CTO Plus - 1 Micron - Chlorine/Chloramine & VOC Reduction

Part #	Description	CASE			
		1±	20±	100±	200±
01-250-10-MATRIKX(R)	10" x 2.5"	\$7.75	\$6.68	\$6.30	\$6.01
01-250-20-MATRIKX(R)	20" x 2.5"	\$19.01	\$16.40	\$15.45	\$14.73
Part #	Description	1±	6±	30±	60±
01-450-10-MATRIKX(R)	10" x 4.5"	\$27.05	\$23.33	\$21.98	\$20.96
Part #	Description	1±	4±	20±	40±
01-450-20-MATRIKX(R)	20" x 4.5"	\$54.96	\$47.41	\$44.66	\$42.60



Pb1®

Matrikx® Pb1® - 0.5 Micron - Chlorine/Chloramine, VOC, CYST, Lead

Part #	Description	CASE			
		1±	20±	100±	200±
06-250-10-MATRIKX(R)	10" x 2.5"	\$11.05	\$9.54	\$8.98	\$8.57
06-250-20-MATRIKX(R)	20" x 2.5"	\$30.99	\$26.73	\$25.18	\$24.02
Part #	Description	1±	6±	30±	60±
06-450-10-MATRIKX(R)	10" x 4.5"	\$40.12	\$34.60	\$32.59	\$31.09
Part #	Description	1±	4±	20±	40±
06-450-20-MATRIKX(R)	20" x 4.5"	\$86.94	\$74.99	\$70.64	\$67.38



ChloraGuard®

Matrikx® ChloraGuard® - 1 Micron - Chloramine Reduction

Part #	Description	CASE			
		1±	20±	100±	200±
36-250-10-MATRIKX(R)	10" x 2.5"	\$17.17	\$14.81	\$13.95	\$13.31
36-250-20-MATRIKX(R)	20" x 2.5"	\$36.50	\$31.48	\$29.66	\$28.29
Part #	Description	1±	6±	30±	60±
36-450-10-MATRIKX(R)	10" x 4.5"	\$54.77	\$47.24	\$44.50	\$42.45
Part #	Description	1±	4±	20±	40±
36-450-20-MATRIKX(R)	20" x 4.5"	\$115.94	\$99.99	\$94.20	\$89.85

Matrikx® Radial Flow GAC Filters

Part #	Description	1±	6±	30±	60±
MKX-B10-RFL	10"BB	\$31.13	\$26.85	\$25.29	\$24.12
Part #	Description	1±	4±	20±	40±
MKX-B20-RFL	20"BB	\$51.88	\$44.74	\$42.15	\$40.21

Housings / Filters



MATRIKX® New and Improved with Enhanced Performance Claims

MATRIKX® CTO

Part Number	Size	Micron Rating Nominal*	Chlorine*	Chloramine*	Pressure Drop*
32-250-10-MATRIKX®	2 3/4" x 9 3/4" (70mmx248mm)	5	12,000 gallons @ 1 gpm 45,500 litres @ 3.8 l/min	1,000 gallons @ 0.5 gpm 3800 litres @ 1.9 l/min	3 PSID @ 1 gpm
32-250-20-MATRIKX®	2 3/4" x 20" (70mmx508mm)	5	24,000 gallons @ 2 gpm 91,000 litres @ 7.6 l/min	2,000 gallons @ 1 gpm 7600 litres @ 3.8 l/min	3 PSID @ 2 gpm
32-450-10-MATRIKX®	4 1/2" x 9 3/4" (114mmx248mm)	5	36,000 gallons @ 3 gpm 136,500 litres @ 11.4 l/min	3,000 gallons @ 1.5 gpm 11,400 litres @ 5.6 l/min	4 PSID @ 3 gpm
32-450-20-MATRIKX®	4 1/2" x 20" (114mmx508mm)	5	51,000 gallons @ 7 gpm 193,500 litres @ 26.6 l/min	6,000 gallons @ 3 gpm 22,800 litres @ 11.4 l/min	7 PSID @ 7 gpm

MATRIKX® CTO PLUS

Part Number	Size	Micron Rating Nominal*	Chlorine*	Chloramine*	VOC*	Pressure Drop*
01-250-10-MATRIKX®	2 3/4" x 9 3/4" (70mmx248mm)	1	30,000 gallons @ 1 gpm 114,000 litres @ 3.8 l/min	2,000 gallons @ 0.5 gpm 7,600 litres @ 1.9 l/min	750 gallons @ 0.5 gpm 2,800 litres @ 1.9 l/min	5 PSID @ 1 gpm
01-250-20-MATRIKX®	2 3/4" x 20" (70mmx508mm)	1	67,500 gallons @ 2 gpm 256,500 litres @ 7.6 l/min	4,000 gallons @ 1 gpm 15,200 litres @ 3.8 l/min	1,500 gallons @ 1 gpm 5,700 litres @ 3.8 l/min	5 PSID @ 2 gpm
01-450-10-MATRIKX®	4 1/2" x 9 3/4" (114mmx248mm)	1	120,000 gallons @ 3 gpm 456,000 litres @ 11.4 l/min	6,000 gallons @ 1.5 gpm 22,800 litres @ 5.6 l/min	2,250 gallons @ 1.5 gpm 8,500 litres @ 5.6 l/min	7 PSID @ 3 gpm
01-450-20-MATRIKX®	4 1/2" x 20" (114mmx508mm)	1	240,000 gallons @ 7 gpm 912,000 litres @ 26.6 l/min	12,000 gallons @ 3 gpm 45,500 litres @ 11.4 l/min	4,500 gallons @ 2 gpm 17,000 litres @ 7.6 l/min	7 PSID @ 7 gpm

MATRIKX® PB1®

Part Number	Size	Micron Rating Nominal*	Chlorine*	Chloramine*	VOC*	Lead*	Cyst*	Pressure Drop*
06-250-10-MATRIKX®	2 3/4" x 9 3/4" (70mmx248mm)	0.5	30,000 gallons @ 1 gpm 114,000 litres @ 3.8 l/min	2,000 gallons @ 0.5 gpm 7,600 litres @ 1.9 l/min	500 gallons @ 0.5 gpm 1890 litres @ 1.9 l/min	3,750 gallons @ 0.75 gpm 14,000 litres @ 2.85 l/min	YES	12 PSID @ 1 gpm
06-250-20-MATRIKX®	2 3/4" x 20" (70mmx508mm)	0.5	67,500 gallons @ 2 gpm 256,500 litres @ 7.6 l/min	4,000 gallons @ 1 gpm 15,200 litres @ 3.8 l/min	1,000 gallons @ 1 gpm 3780 litres @ 3.8 l/min	7,500 gallons @ 1.5 gpm 28,500 litres @ 5.6 l/min	YES	12 PSID @ 2 gpm
06-450-10-MATRIKX®	4 1/2" x 9 3/4" (114mmx248mm)	0.5	120,000 gallons @ 3 gpm 456,000 litres @ 11.4 l/min	6,000 gallons @ 1.5 gpm 22,800 litres @ 5.6 l/min	1,500 gallons @ 1.5 gpm 5670 litres @ 5.6 l/min	12,000 gallons @ 2.5 gpm 45,500 litres @ 9.5 l/min	YES	14 PSID @ 3 gpm
06-450-20-MATRIKX®	4 1/2" x 20" (114mmx508mm)	0.5	240,000 gallons @ 7 gpm 912,000 litres @ 26.6 l/min	12,000 gallons @ 3 gpm 45,500 litres @ 11.4 l/min	3,000 gallons @ 2 gpm 11,350 litres @ 7.6 l/min	25,500 gallons @ 5 gpm 97,000 litres @ 19 l/min	YES	14 PSID @ 7 gpm

MATRIKX® CHLORAGUARD®

Part Number	Size	Micron Rating Nominal*	Chlorine*	Chloramine*	VOC*	Pressure Drop*
36-250-10-MATRIKX®	2 3/4" x 9 3/4" (70mmx248mm)	1	45,000 gallons @ 1 gpm 171,000 litres @ 3.8 l/min	4,000 gallons @ 0.5 gpm 15,200 litres @ 1.9 l/min	750 gallons @ 0.5 gpm 2,800 litres @ 1.9 l/min	5 PSID @ 1 gpm
36-250-20-MATRIKX®	2 3/4" x 20" (70mmx508mm)	1	90,000 gallons @ 2gpm 342,000 litres @ 7.6 l/min	8,000 gallons @ 1 gpm 30,000 litres @ 3.8 l/min	1,500 gallons @ 1 gpm 5,700 litres @ 3.8 l/min	5 PSID @ 2 gpm
36-450-10-MATRIKX®	4 1/2" x 9 3/4" (114mmx248mm)	1	180,000 gallons @ 3gpm 684,000 litres @ 11.4 l/min	12,000 gallons @ 1.5 gpm 45,500 litres @ 5.6 l/min	2,250 gallons @ 1.5 gpm 8,500 litres @ 5.6 l/min	7 PSID @ 3 gpm
36-450-20-MATRIKX®	4 1/2" x 20" (114mmx508mm)	1	360,000 gallons @ 7 gpm 1,368,000 litres @ 26.6 l/min	24,000 gallons @ 3 gpm 91,000 litres @ 11.4 l/min	4,500 gallons @ 2 gpm 17,000 litres @ 7.6 l/min	7 PSID @ 7 gpm

MATRIKX® Radial Flow GAC Filter

Part Number	Size	Micron Rating Nominal*	Chlorine Taste & Odor Reduction @ Flow Rate (GPM)*	Initial ΔP (PSI) @ Flow Rate (GPM)*
MKX-B10-RFL	4 1/2" x 9 3/4" (114mm X 248mm)	20	>50,000 gallons @ 2 gpm (189,270 L @ 7.6 Lpm)	0.90 psi @ 2 gpm (0.06 bar @ 7.6 Lpm)
			>20,000 gallons @ 3 gpm (>76,000 litres @ 11.4 Lpm)	0.90 p1.0 psi @ 3 gpm (0.07 bar @ 11.4 Lpm)
MKX-B20-RFL	4 1/2" x 20" (114mm X 508mm)	20	>100,000 gallons @ 4 gpm (378,541 L @ 15.2 Lpm)	0.90 psi @ 2 gpm (0.06 bar @ 7.6 Lpm)
			>40,000 gallons @ 7 gpm (>152,000 litres @ 26.6 Lpm)	3.0 psi @ 7 gpm (.21 bar @ 26.6 Lpm)

* Performance claims are based on internal testing. Actual performance claims may vary depending on water quality, system, and application.

Housings / Filters



FILTREX® CARBON FILTERS



Filtrex Technologies is the first carbon block manufacturer to use NSF61 listed greencarbon™ developed by Global ECOCARB Pvt Ltd. This high performance coconut shell carbon is manufactured using a patented process that significantly reduces harmful Green House Gas Emissions.

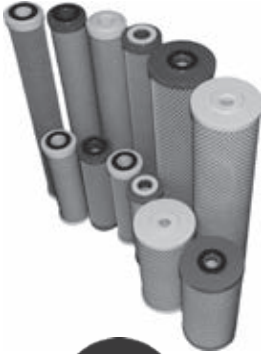

CL2 Series GreenBlock™ Filters

Part #	Description	CASE			
		1±	25±	125±	250±
FX10CL2	2.5" X 10" 10MIC. GREENBLOCK™	\$5.97	\$5.22	\$4.85	\$4.48
FX20CL2	2.5" X 20" 10MIC. GREENBLOCK™	\$16.01	\$14.01	\$13.01	\$12.01
Part #	Description	1±	12±	60±	120±
FXB10CL2	4.5" X 10" 10MIC.	\$24.36	\$21.32	\$19.79	\$18.27
Part #	Description	1±	4±	20±	40±
FXB20CL2	4.5" X 20" 10MIC.	\$48.76	\$42.66	\$39.62	\$36.57

VOC Series GreenBlock™ Filters

Part #	Description	CASE			
		1±	25±	125±	250±
FX10VOC	2.5" X 10" 5MIC.	\$7.02	\$6.14	\$5.70	\$5.26
FX20VOC	2.5" X 20" 5MIC.	\$17.71	\$15.50	\$14.39	\$13.28
Part #	Description	1±	12±	60±	120±
FXB10VOC	4.5" X 10" 5MIC.	\$24.36	\$21.32	\$19.79	\$18.27

Ceramic GreenBlock™ Filters

Part #	Description	CASE			
FX10CERAMIC	2.5" X 10" 0.2MIC. CERAMIC GREENBLOCK™	1±	25±	125±	250±
		\$14.12	\$12.35	\$11.47	\$10.59

Compatible Filters

Part #	Description	CASE			
FXCUL12CL2	CULLIGAN 10M CARBON BLOCK GREENBLOCK™	1±	25±	125±	250±
FXHTC11CL2	HYDROTECH/CLACK 10M CARBON BLOCK GREENBLOCK™	\$7.20	\$6.11	\$4.97	\$4.58
		\$7.20	\$5.76	\$4.68	\$4.32



Housings / Filters



OMNIPURE® CARBON FILTERS

Carbon Block
(OMB934XF)

9 3/4" X 2.5" Carbon Block Filter Cartridges

Part #	Description	CASE			
		1±	20±	100±	200±
OMB934-0.5	0.5 MIC.	\$9.99	\$9.12	\$8.12	\$7.75
OMB934-1	1 MIC.	\$10.27	\$9.37	\$8.34	\$7.96
OMB934-1L	1 MIC. LEAD REMOVAL	\$13.49	\$12.31	\$10.96	\$10.45
OMB934-KDF	1 MIC CARBON BLK WITH KDF 3 OZ.	\$15.24	\$13.91	\$12.39	\$11.81
OMB934-1M-P	1 MIC. CARBON/PHOSPAHTE BLOCK	\$13.60	\$12.41	\$11.05	\$10.54
OMB934-1ML-KDF	1 MIC LEAD/CARBON/KDF (3 OZ) BLOCK	\$20.62	\$18.82	\$16.75	\$15.98
OMB934XF	10 MIC. CARBON BLOCK	\$5.35	\$4.85	\$4.57	\$4.50
OMB934XF-KDF	10 MIC. CARBON/KDF (3 OZ) BLOCK	\$14.42	\$13.16	\$11.72	\$11.18
Part #	Description	1±	20±	200±	1260±
OMB934-MAX5	10" 5M COCO CARBON BLOCK; USA	\$5.12	\$4.64	\$4.37	\$4.30

20" X 2.5" Carbon Block Filter Cartridges

Part #	Description	CASE			
		1±	9±	45±	90±
OMB200-1M	1 MIC. CARBON BLOCK	\$21.25	\$19.39	\$17.26	\$16.47
OMB200-1ML	1 MIC. LEAD CARBON BLOCK	\$32.62	\$29.77	\$26.50	\$25.28
OMB200-1M-P	1 MIC. CARBON/PHOSPHATE BLOCK	\$37.28	\$34.02	\$30.29	\$28.90
OMB200-MAX5	5 MIC. CARBON BLOCK	\$15.24	\$13.91	\$12.39	\$11.81
OMB200XF	10 MIC. CARBON BLOCK	\$15.24	\$13.91	\$12.39	\$11.81

GAC Filter Cartridges

Part #	Description	CASE			
		1±	25±	125±	250±
OCB934ROT40	9 3/4" X 2.5" T40 GAC COCONUT	\$8.81	\$8.04	\$7.16	\$6.83
Part #	Description	1±	9±	45±	90±
OCB200 T29	20" x 2.5" CENTAUR CARTRIDGE	\$33.21	\$31.55	\$26.99	\$25.74
OCB200 T40	20" x 2.5" GAC T40 COCO CARTRIDGE	\$24.66	\$22.50	\$20.03	\$19.11

GAC With Phosphate Filter Cartridges

Part #	Description	CASE			
		1±	20±	100±	200±
POCB934	9 3/4" X 2.5" GAC/PHOSPHATE CARTRIDGE	\$17.30	\$15.79	\$14.06	\$13.41
POCB934-6OZ	9 3/4" X 2.5" GAC/PHOS 6OZ CARTRIDGE	\$15.44	\$14.09	\$12.54	\$11.97
Part #	Description	1±	9±	45±	90±
POCB200	19 3/4" X 2.5" GAC/PHOSPHATE CARTRIDGE	\$32.29	\$29.46	\$26.24	\$25.02

GAC Filter Cartridges

10" 100% Poly Phosphate Cartridge

Part #	Description	CASE			
		1±	10±	50±	100±
POB934	10" x 2.5" 100% PHOSPHATE CARTRIDGE	\$44.83	\$40.91	\$36.43	\$34.74

GAC Filter Cartridges

OMNIPURE® CL-SERIES - INLINE FILTERS



The **CL-Series**. This simple but dependable inline filter has a variety of uses including ice machines, water coolers, drinking fountains, under-the-sink applications, and as components in reverse osmosis systems.



CL-Series Filters

2" X 6" 5 Mic. Sediment Inline

Part #	Description	CASE			
		1±	50±	250±	500±
CL6PF5-A	1/8" FPT	\$7.59	\$6.93	\$6.17	\$5.89
CL6PF5-B	1/4" FPT	\$7.59	\$6.93	\$6.17	\$5.89
CL6PF5-C	3/8" FPT	\$7.59	\$6.93	\$6.17	\$5.89

2" X 6" T40 GAC Acid Washed Coconut Inline

Part #	Description	CASE			
		1±	50±	250±	500±
CL6ROT40-B	1/4" FPT	\$7.10	\$6.48	\$5.77	\$5.51
CL6ROT40-C	3/8" FPT	\$7.10	\$6.48	\$5.77	\$5.51



Good Water Warehouse, Inc.

CANADASALES@GOODWATERWAREHOUSE.COM
GOODWATERWAREHOUSE.COM

PRICES ARE USD FOB
CALGARY/NEWMARKET

ALBERTA
TEL: (403) 252-7972
TEL: (888) 668-1234
FAX: (888) 227-3291

ONTARIO
TEL: (905) 868-9287
TEL: (888) 868-9287
FAX: (905) 830-0512



CL-Series Filters

2" X 10" 5 Mic. Sediment Inline

Part #	Description	CASE			
		1±	25±	125±	250±
CL10PF5-A	1/8" FPT	\$8.53	\$7.78	\$6.93	\$6.61
CL10PF5-B	1/4" FPT	\$8.53	\$7.78	\$6.93	\$6.61
CL10PF5-C	3/8" FPT	\$8.53	\$7.78	\$6.93	\$6.61

2" X 10" T40 GAC Acid Washed Coconut Inline

Part #	Description	CASE			
		1±	25±	125±	250±
CL10ROT40-B	1/4" FPT	\$7.61	\$6.95	\$6.19	\$5.90
CL10ROT40-C	3/8" FPT	\$7.61	\$6.95	\$6.19	\$5.90

2" X 10" GAC & Phosphate Scale Inhibitor Inline

Part #	Description	CASE			
		1±	25±	125±	250±
SCL10-A	GAC CARBON / PHOSPHATE 1/8" FPT	\$10.12	\$9.24	\$8.22	\$7.85
SCL10-B	GAC CARBON / PHOSPHATE 1/4" FPT	\$10.10	\$9.21	\$8.20	\$7.83
SCL10-C	GAC CARBON / PHOSPHATE 3/8" FPT	\$10.12	\$9.24	\$8.22	\$7.85
SL10-B	ALL PHOSPHATE 1/4" FPT	\$22.19	\$20.25	\$18.03	\$17.20
SL10-C	ALL PHOSPHATE 3/8" FPT	\$22.19	\$20.25	\$18.03	\$17.20

OMNIPURE® K-SERIES - INLINE FILTERS



Housings / Filters



K-Series Filters

5 Mic. Sediment Inline

Part #	Description	CASE			
		1±	50±	250±	500±
K2305-JJ	2" X 6" 5 MIC SEDIMENT INLINE 1/4" FQC	\$12.50	\$11.40	\$10.15	\$9.69
K2305-KK	2" X 6" 5 MIC SEDIMENT INLINE 3/8" FQC	\$10.54	\$9.62	\$8.56	\$8.17

Part #	Description	1±	25±	125±	250±
		K2505-JJ	2" X 10" 5 MIC SED. INLINE 1/4" FQC	\$10.60	\$9.67
K5505-BB	2.5" X 10" 5 MIC SED. INLINE 1/4" FPT	\$10.65	\$9.72	\$8.65	\$8.25
K5505-JJ	2.5" X 10" 5 MIC SED. INLINE 1/4" FQC	\$12.72	\$11.60	\$10.33	\$9.86
K5605-BB	2.5" X 12" 5 MIC SED. INLINE 1/4" FPT	\$11.45	\$10.45	\$9.31	\$8.88
K5605-JJ	2.5" X 12" 5 MIC SED. INLINE 1/4" FQC	\$12.71	\$11.60	\$10.33	\$9.85

T40 GAC Coconut Carbon Inline

Part #	Description	CASE			
		1±	50±	250±	500±
K2340-JJ	2" x 6" T40 COCO CARBON INLINE; 1/4" FQC	\$8.67	\$7.91	\$7.05	\$6.72
K2340-KK	2" x 6" T40 COCO CARBON INLINE; 3/8" FQC	\$9.55	\$8.72	\$7.76	\$7.41

Part #	Description	1±	25±	125±	250±
		K2540-JJ	2" X 10" T40 COCO CARBON INLINE; 1/4" FQC	\$9.93	\$9.06
K2540-KK	2" X 10" T40 COCO CARBON INLINE; 3/8" FQC	\$10.82	\$9.87	\$8.79	\$8.38
K5540-BB	2.5" x 10" T40 COCO CARBON INLINE; 1/4" FPT	\$10.60	\$9.67	\$8.61	\$8.21
K5540-CC	2.5" x 10" T40 COCO CARBON INLINE; 3/8" FPT	\$10.60	\$9.67	\$8.61	\$8.21
K5540-JJ	2.5" x 10" T40 COCO CARBON INLINE; 1/4" FQC	\$12.65	\$11.54	\$10.28	\$9.80
K5640-BB	2.5" x 12" T40 COCO CARBON INLINE; 1/4" FPT	\$10.55	\$9.63	\$8.58	\$8.18
K5640-CC	2.5" x 12" T40 COCO CARBON INLINE; 3/8" FPT	\$10.77	\$9.82	\$8.75	\$8.34
K5640-JJ	2.5" x 12" T40 COCO CARBON INLINE; 1/4" FQC	\$12.63	\$11.53	\$10.26	\$9.79
K5640-KK	2.5" x 12" T40 COCO CARBON INLINE; 3/8" FQC	\$13.43	\$12.25	\$10.91	\$10.41

GAC With Phosphate Inline

Part #	Description	CASE			
		1±	50±	250±	500±
K2386-JJ	2" X 6" GAC / PHOSPHATE 1/4" FQC	\$10.56	\$9.64	\$8.58	\$8.19
K2386-KK	2" X 6" GAC / PHOSPHATE 3/8" FQC	\$11.44	\$10.44	\$9.30	\$8.87
K2385-JJ	2" X 6" ALL PHOSPHATE 1/4" FQC	\$17.32	\$15.81	\$14.07	\$13.43

Part #	Description	1±	25±	125±	250±
		K2586-JJ-2 OZ.	2" X 10" GAC / PHOSPHATE 2 OZ. 1/4" FQC	\$12.18	\$11.12
K2586-JJ	2" X 10" GAC / PHOS 60/40 4OZ 1/4" FQC	\$13.51	\$12.32	\$10.97	\$10.47
K2586-BB-6OZ	2" X 10" T40 COCO S./ PHOS6OZ 1/4" FPT	\$14.39	\$13.13	\$11.69	\$11.15
K5586-BB	2.5" X 10" GAC / PHOSPHATE 1/4" FPT	\$14.52	\$13.25	\$11.80	\$11.26
K5586-JJ	2.5" X 10" GAC / PHOSPHATE 1/4" FQC	\$16.80	\$15.33	\$13.65	\$13.02
K5586-KK	2.5" X 10" GAC / PHOSPHATE 3/8" FQC	\$17.77	\$16.22	\$14.44	\$13.77
K5686-BB	2.5" X 12" GAC / PHOSPHATE 1/4" FPT	\$14.06	\$12.83	\$11.43	\$10.90
K5686-JJ	2.5" X 12" GAC / PHOSPHATE 1/4" FQC	\$16.13	\$14.72	\$13.11	\$12.50
K5686-KK	2.5" X 12" GAC / PHOSPHATE 3/8" FQC	\$17.01	\$15.52	\$13.82	\$13.18

K-Series Connection Fittings & Codes

A = 1/8" straight female machine thread

B = 1/4" straight female machine thread

C = 3/8" straight female machine thread

J = 1/4" straight female QC

K = 3/8" straight female QC

S = 90° single female QC

T = 90° twin female QC (inlet only)



K-Series Filters

The **K-Series** filter is available in 6", 8", 10", 12" or 14" lengths manufactured in 2" or 2.5" diameters. The true benefit is that systems can be designed to incorporate the various lengths & diameters - either all the same size or intermixed - to meet specific filtration needs.

K-Series Connection Fittings & Codes

- A** = 1/8" straight female machine thread
- B** = 1/4" straight female machine thread
- C** = 3/8" straight female machine thread
- J** = 1/4" straight female QC
- K** = 3/8" straight female QC
- S** = 90° single female QC
- T** = 90° twin female QC (inlet only)

Phosphate - Scale Inhibitor

Part #	Description	CASE			
		1+	25+	125+	250+
K2585-BB	2" X 10" ALL PHOSPHATE FLTR;1/4FPT	\$22.19	\$20.25	\$18.03	\$17.20
K2585-JJ	2" X 10" ALL PHOSPHATE FLTR;1/4QC	\$24.18	\$22.07	\$19.65	\$18.74

GAC With KDF-55 Inlines

Part #	Description	CASE			
		1+	50+	250+	500+
K2350-BB	2" X 6" GAC 1/4 LBS. KDF 1/4" FPT	\$10.94	\$9.99	\$8.89	\$8.48
K2350-CC	2" X 6" GAC 1/4 LBS. KDF 3/8" FPT	\$10.94	\$9.99	\$8.89	\$8.48
K2356-JJ	2" X 6" ALL KDF-55 1/4" FQC	\$33.26	\$30.35	\$27.02	\$25.77
Part #	Description	1+	25+	125+	250+
K2556-JJ	2" X 10" ALL KDF-55 1/4" FQC	\$49.94	\$45.57	\$40.58	\$38.71
K2567-BB	2" X 10" T33/1/2 LB. KDF 1/4" FPT	\$13.43	\$12.25	\$10.91	\$10.41
K2567-BB-1M	2" X 10" T33/1/2 LB. KDF/1MIC PAD, 1/4" F	\$13.43	\$12.25	\$10.91	\$10.41
K2567-JJ	2" X 10" T33/1/2 LB. KDF 1/4" FQC	\$15.72	\$14.34	\$12.77	\$12.18
K2567-KK	2" X 10" T33/1/2 LB. KDF 3/8" FQC	\$16.69	\$15.23	\$13.56	\$12.94
K5567-BB	2.5" X 10" T33/1/2 LB. KDF 1/4" FPT	\$16.54	\$15.09	\$13.44	\$12.82
K5567-BB-1M	2.5" X 10" T33/1/2 LB. KDF/1MIC PAD, 1/4" F	\$16.54	\$15.09	\$13.44	\$12.82
K5668-BB	2.5" X 12" T33 GAC/1 LB. KDF 1/4" FPT	\$26.10	\$23.81	\$21.21	\$20.23
K5668-CC	2.5" X 12" T33 GAC /1 LB. KDF 3/8" FPT	\$26.10	\$23.81	\$21.21	\$20.23

1 Mic. Carbon Block Inline

Part #	Description	CASE			
		1+	50+	250+	500+
K2320-BB	2" X 6" 1/4" FPT	\$12.40	\$11.32	\$10.08	\$9.61
K2320-JJ	2" X 6" 1/4" FQC	\$14.47	\$13.21	\$11.76	\$11.22
K2320-KK	2" X 6" 3/8" FQC	\$15.35	\$14.00	\$12.47	\$11.89
Part #	Description	1+	25+	125+	250+
K2520-BB	2" X 10" 1/4" FPT	\$15.22	\$13.89	\$12.37	\$11.80
K2520-JJ	2" X 10" 1/4" FQC	\$17.28	\$15.77	\$14.04	\$13.39
K5520-BB	2.5" X 10" 1/4" FPT	\$17.28	\$15.77	\$14.04	\$13.39
K5520-JJ	2.5" X 10" 1/4" FQC	\$19.34	\$17.65	\$15.71	\$14.99
K5620-BB	2.5" X 12" 1/4" FPT	\$18.33	\$16.73	\$14.89	\$14.21

1 Mic. Carbon Block With Phosphate Scale Inhibitor

Part #	Description	CASE			
		1+	25+	125+	250+
K5520P-BB	2.5" X 10" 1 MIC / PHOSPHATE 1/4" FPT	\$19.92	\$18.17	\$16.18	\$15.44
K5520P-JJ	2.5" X 10" 1 MIC./ PHOSPHATE 1/4" FQC	\$21.97	\$20.05	\$17.85	\$17.03

1 Mic. Carbon Block With Lead & Cyst. Reduction

Part #	Description	CASE			
		1+	25+	125+	250+
K2515-JJ	2" X 10" 1 MIC / LEAD 1/4" FQC	\$18.53	\$16.90	\$15.05	\$14.36
K5515-BB	2.5" X 10" 1 MIC / LEAD 1/4" FPT	\$19.34	\$17.65	\$15.71	\$14.99
K5515-JJ	2.5" X 10" 1 MIC / LEAD 1/4" FQC	\$21.70	\$19.80	\$17.63	\$16.82
K5615-BB	2.5" X 12" 1 MIC / LEAD 1/4" FPT	\$21.00	\$19.16	\$17.06	\$16.28
K5615-JJ	2.5" X 12" 1 MIC / LEAD 1/4" FQC	\$23.07	\$21.05	\$18.75	\$17.88

5 mic Carbon Block Inline

Part #	Description	CASE			
		1+	25+	125+	250+
K5522-BB	2.5" X 10" 5 MIC 1/4" FPT	\$15.70	\$14.33	\$12.76	\$12.17
K5622-BB	2.5" X 12" 5 MIC 1/4" FPT	\$16.54	\$15.09	\$13.44	\$12.82

10 Mic. Carbon Block Inline

Part #	Description	CASE			
		1+	25+	125+	250+
K2521-BB	2" X 10" 10 MIC 1/4" FPT	\$14.10	\$12.87	\$11.46	\$10.93
K2521-JJ	2" X 10" 10 MIC 1/4" FQC	\$16.42	\$14.99	\$13.34	\$12.73
K2521-KK	2" X 10" 10 MIC 3/8" FQC	\$17.26	\$15.75	\$14.03	\$13.38
K5521-BB	2.5" X 10" 10 MIC 1/4" FPT	\$15.20	\$13.87	\$12.35	\$11.78
K5521-JJ	2.5" X 10" 10 MIC 1/4" FQC	\$17.26	\$15.75	\$14.03	\$13.38
K5621-BB	2.5" X 12" 10 MIC 1/4" FPT	\$16.06	\$14.65	\$13.05	\$12.45
K5621-JJ	2.5" X 12" 10 MIC 1/4" FQC	\$18.11	\$16.53	\$14.72	\$14.04

DI Mixbed Inline

Part #	Description	CASE			
		1+	25+	125+	250+
K2555-BB	2" X 10" DI INLINE 1/4" FPT	\$15.03	\$13.72	\$12.21	\$11.65
K5555-BB	2.5" X 10" DI INLINE 1/4" FPT	\$18.53	\$16.90	\$15.05	\$14.36
K5555-JJ	2.5" X 10" DI INLINE 1/4" FQC	\$20.59	\$18.79	\$16.73	\$15.96
K5655-BB	2.5" X 12" DI INLINE 1/4" FPT	\$22.19	\$20.25	\$18.03	\$17.20
K5655-BB-NRW37	2.5" X 12" ALL NRW37-DI 1/4" FPT	\$22.19	\$20.25	\$18.03	\$17.20
K5655-JJ-NRW37	2.5" X 12" ALL NRW37-DI 1/4" FQC	\$24.26	\$22.14	\$19.71	\$18.80
K5655-SS-NRW37	2.5" X 12" ALL NRW37-DI 1/4" JG 90°	\$24.54	\$22.39	\$19.94	\$19.02

Housings / Filters



K-Series Filters

Nitrate Removal Inline

Part #	Description	CASE			
		1±	25±	125±	250±
K2553-BB	2" X 10" NITRATE REMOVAL A520E 1/4" F	\$16.65	\$15.19	\$13.53	\$12.91
K2553-JJ	2" X 10" NITRATE REMOVAL A520E 1/4" Q	\$20.59	\$18.79	\$16.73	\$15.96
K2553-KK	2" X 10" NITRATE REMOVAL A520E 3/8" Q	\$21.48	\$19.61	\$17.46	\$16.65
K5553-BB	2.5" X 10" NITRATE CARTRIDGE 1/4" FPT	\$24.07	\$21.97	\$19.56	\$18.66
K5553-JJ	2.5" X 10" NITRATE CARTRIDGE 1/4" FQC	\$26.13	\$23.85	\$21.23	\$20.25

Remineralization Filters - Calcite Inline

Part #	Description	CASE			
		1±	25±	125±	250±
K2548-BB	2"X10" ALL CALCITE;1/4" FPT	\$8.95	\$8.17	\$7.27	\$6.94
K2548-CC-ALLCAL	2"X10" ALL CALCITE;3/8" FPT	\$8.95	\$8.17	\$7.27	\$6.94
K2548-JJ	2"X10" ALL CALCITE;1/4" FQC	\$11.00	\$10.03	\$8.93	\$8.52
K2548-KK	2"X10" ALL CALCITE;3/8" FQC	\$11.89	\$10.85	\$9.66	\$9.21

Calcite/Corosex - For Higher pH

Part #	Description	CASE			
		1±	25±	125±	250±
K2550-C/C-70/30-JJ	2"X10";70% CALCITE-30%COROSEX; ;1/4 JG	\$13.22	\$12.06	\$10.74	\$10.24
K2551-C/C-JJ	2"X10";50% CALCITE-50%COROSEX; ;1/4 JG	\$13.11	\$11.96	\$10.65	\$10.16
K2551-C/C-BB	2"X10";1/2 COR;1/2 CAL;1/4 FPT	\$11.44	\$10.44	\$9.29	\$8.86
K2551-KK	2"X10" 1/2 CAL 1/2 COROSEX ;3/8" QC	\$13.28	\$12.11	\$10.79	\$10.29

Activate Alumina - Fluoride Reducer

Part #	Description	CASE			
		1±	25±	125±	250±
K2566-BB	2"X10" ACTIVATED ALUMINA INL;1/4"FPT	\$21.93	\$20.02	\$17.82	\$17.00

OMNIPURE® Q-SERIES - TWIST OFF FILTERS



Q-Series Filters

Sediment 2.5" Diameter

Part #	Description	CASE			
		1±	25±	125±	250±
Q5305	6" 5 MICRON	\$11.64	\$10.62	\$9.46	\$9.02
Q5405	8" 5 MICRON	\$11.58	\$10.57	\$9.41	\$8.98
Q5505	10" 5 MICRON	\$12.80	\$11.68	\$10.40	\$9.92
Q5605	12" 5 MICRON	\$12.72	\$11.60	\$10.33	\$9.86
Q5325	6" 25 MIC. SEDIMENT	\$10.72	\$9.79	\$8.71	\$8.31
Q5425	8" 25 MIC. SEDIMENT	\$11.80	\$10.77	\$9.59	\$9.15
Q5625	12" 25 MIC. SEDIMENT	\$14.00	\$12.77	\$11.37	\$10.85
Part #	Description	1±	20±	100±	200±
Q5705	14" 5 MICRON	\$15.59	\$14.23	\$12.67	\$12.08

T33 Acid Washed GAC 2.5" Diameter

Part #	Description	CASE			
		1±	25±	125±	250±
Q5333	6" T33	\$11.34	\$10.35	\$9.22	\$8.79
Q5433	8" T33	\$12.11	\$11.05	\$9.84	\$9.39
Q5533	10" T33	\$13.17	\$12.01	\$10.70	\$10.20
Q5633	12" T33	\$14.24	\$13.00	\$11.57	\$11.04

T40 Coconut Carbon GAC 2.5" Diameter

Part #	Description	CASE			
		1±	25±	125±	250±
Q5540	10" T40 COCONUT GAC	\$13.17	\$12.01	\$10.70	\$10.20
Q5640	12" T40 COCONUT GAC	\$14.24	\$13.00	\$11.57	\$11.04

1 Mic. Carbon Block 2.5" Diameter

Part #	Description	CASE			
		1±	25±	125±	250±
Q5320	6" 1 MIC	\$14.63	\$13.35	\$11.89	\$11.34
Q5420	8" 1 MIC	\$15.49	\$14.13	\$12.59	\$12.01
Q5520	10" 1 MIC	\$16.41	\$14.97	\$13.33	\$12.72
Q5620	12" 1 MIC	\$19.85	\$18.11	\$16.13	\$15.38
Part #	Description	1±	20±	100±	200±
Q5720	14" 1 MIC	\$32.40	\$29.56	\$26.32	\$25.11

1 Mic. Carbon Block with Lead Removal 2.5" Diameter

Part #	Description	CASE			
		1±	25±	125±	250±
Q5315	6" 1 MIC WITH LEAD REMOVAL	\$15.05	\$13.73	\$12.23	\$11.66
Q5415	8" 1 MIC WITH LEAD REMOVAL	\$16.91	\$15.43	\$13.74	\$13.10
Q5515	10" 1 MIC WITH LEAD REMOVAL	\$20.26	\$18.48	\$16.46	\$15.70
Q5615	12" 1 MIC WITH LEAD REMOVAL	\$21.52	\$19.64	\$17.48	\$16.68

1 Mic. Carbon Block with Phosphate 2.5" Diameter

Part #	Description	CASE			
		1±	25±	125±	250±
Q5420-P	8" 1 MIC WITH PHOSPHATE	\$15.85	\$14.46	\$12.88	\$12.28
Q5520-P	10" 1 MIC WITH PHOSPHATE	\$18.41	\$16.80	\$14.96	\$14.27



Easy to use Twist Off Filters

(No tools. No drips. No hassles)

The **Q-Series** is the ultimate "user friendly" inline filter on the market. Replacement of the spent media bed is completed in a matter of seconds by detaching the filter body from a permanent head with a twist of the wrist. The new filter body is just as easily threaded into the head and the replacement is then complete.



Q-Series Filters

Valved Head



Non-Valved Head



1 Mic. Carbon Block Lead & Phosphate 2.5" Diameter CASE

Part #	Description	1+	25+	125+	250+
Q5415-P	8" 1 MIC WITH LEAD/PHOSPHATE	\$18.76	\$17.12	\$15.25	\$14.54
Q5515-P	10" 1 MIC WITH LEAD/PHOSPHATE	\$22.49	\$20.52	\$18.27	\$17.43
Q5615-P	12" 1 MIC WITH LEAD/PHOSPHATE	\$23.98	\$21.88	\$19.48	\$18.58
Part #	Description	1+	20+	100+	200+
Q5715-P	14" 1 MIC WITH LEAD/PHOSPHATE	\$39.49	\$36.03	\$32.08	\$30.60

10 Mic. Carbon Block 2.5" Diameter

Part #	Description	1+	25+	125+	250+
Q5321	6" 10 MIC	\$12.42	\$11.33	\$10.09	\$9.63
Q5421	8" 10 MIC	\$13.11	\$11.96	\$10.65	\$10.16
Q5521	10" 10 MIC	\$14.28	\$13.03	\$11.60	\$11.07
Q5621	12" 10 MIC	\$16.81	\$15.34	\$13.66	\$13.03
Part #	Description	1+	20+	100+	200+
Q5721	14" 10 MIC	\$28.34	\$25.86	\$23.02	\$21.96
Q5721-P	14" 10 MIC WITH PHOSPHATE	\$30.35	\$27.70	\$24.66	\$23.53

10 Mic. Carbon Block With Phosphate 2.5" Diameter CASE

Part #	Description	1+	25+	125+	250+
Q5321-P	6" 10 MIC WITH PHOSPHATE	\$14.65	\$13.37	\$11.90	\$11.35
Q5621-P	12" 10 MIC WITH PHOSPHATE	\$19.05	\$17.38	\$15.48	\$14.77
Part #	Description	1+	20+	100+	200+
Q5721-P	14" 10 MIC WITH PHOSPHATE	\$30.35	\$27.70	\$24.66	\$23.53

Phosphate 2.5" Diameter

Part #	Description	1+	25+	125+	250+
Q5385	6" PHOSPHATE	\$20.19	\$18.42	\$16.40	\$15.65
Q5485	8" PHOSPHATE	\$27.31	\$24.92	\$22.19	\$21.17
Part #	Description	1+	20+	100+	200+
Q5785	14" PHOSPHATE	\$37.27	\$34.01	\$30.29	\$28.89

Softening Filters 2.5" Diameter

Part #	Description	1+	25+	125+	250+
Q5554-C100E	10" C100E	\$14.93	\$13.62	\$12.13	\$11.57
Q5654-C100E	12" C100E	\$15.74	\$14.36	\$12.79	\$12.20
Part #	Description	1+	20+	100+	200+
Q5754-C100E	14" C100E	\$17.07	\$15.57	\$13.87	\$13.23

Miscellaneous Filters 2.5" Diameter

Part #	Description	1+	25+	125+	250+
Q5467	8" T33 GAC / 1/2 LB KDF	\$21.43	\$19.56	\$17.42	\$16.61
Q5567	10" T33 GAC / 1/2 LB KDF	\$21.75	\$19.85	\$17.67	\$16.86
Q5562	10" ALL NRW-37 DI MIXBED	\$22.43	\$20.46	\$18.22	\$17.38
Q5655	12" MIXBED DI	\$23.76	\$21.68	\$19.30	\$18.41
Q5662	12" ALL NRW-37; DI MIXED BED	\$23.76	\$21.68	\$19.30	\$18.41

Valved Head - Will Shut Off Water When Filter Is Removed

Part #	Description	1+	25+	125+	250+
VH1/4	1/4" FPT	\$20.65	\$18.85	\$16.78	\$16.01
VH1/4-JG	1/4" JG	\$23.37	\$21.32	\$18.99	\$18.11
VH3/8	3/8" FPT	\$20.65	\$18.85	\$16.78	\$16.01

Non-Valved Head

Part #	Description	1+	25+	125+	250+
NVH1/4	1/4" FPT	\$10.39	\$9.48	\$8.45	\$8.06
NVH1/4-JG	1/4" JG	\$13.08	\$11.94	\$10.63	\$10.14
NVH3/8	3/8" FPT	\$10.39	\$9.48	\$8.45	\$8.06

Q-Series Valve Head O-Rings

Part #	Description	1+	10+	50+	100+
H-118	Q-SERIES HEAD O-RING; LARGE	\$0.41	\$0.38	\$0.34	\$0.32
H-011	Q-SERIES HEAD O-RING; SMALL	\$0.41	\$0.38	\$0.34	\$0.32

Q-Series Brackets

Part #	Description	1+	10+	50+	100+
Q-BRACKET	SINGLE Q-SERIES BRACKET; L	\$2.48	\$2.26	\$2.02	\$1.92
Part #	Description	1+	10+	25+	
A-A-BVG2	2 STAGE; 7 1/4" X 3"; Z STYLE	\$6.97	\$6.50	\$6.04	
A-BVG2	2 STAGE; 7 1/4" X 3"; Z STYLE; ELEC.P	\$11.36	\$10.60	\$9.84	
A-BVG3	3 STAGE; 10 1/2" X 3" Z STYLE; ELEC.P	\$10.44	\$9.75	\$9.05	
A-BV3	3 STAGE; 11" X 4 1/8"; U STYLE	\$12.01	\$11.21	\$10.41	
A-BV4	4 STAGE; 11" X 4 1/8"; U STYLE	\$12.88	\$12.03	\$11.17	

Housings / Filters



OMNIPURE® L-SERIES - TWIST OFF FILTERS



L-Series Filters

2.5" X 10" L-Series Filters

Part #	Description	CASE			
		1±	20±	100±	200±
L5505	2.5" X 10" 5M SED	\$14.84	\$13.54	\$12.06	\$11.50
L5515	2.5" X 10" 1M LEAD CARBON BLOCK	\$18.63	\$17.00	\$15.14	\$14.44
L5520	2.5" X 10" 1M CARBON BLOCK;	\$17.14	\$15.64	\$13.93	\$13.29
L5521	2.5" X 10" 10M CARBON BLOCK	\$13.75	\$12.55	\$11.17	\$10.66
L5533	2.5" X 10" T33 GAC	\$14.15	\$12.91	\$11.50	\$10.97
L5586	2.5" X 10" CAR/PHOSPHATE	\$14.95	\$13.64	\$12.15	\$11.58

2.5" X 12" L-Series Filters

Part #	Description	CASE			
		1±	20±	100±	200±
L5605	2.5" X 12" 5M SED	\$13.51	\$12.32	\$10.97	\$10.47
L5620	2.5" X 12" 1M BLOCK	\$17.81	\$16.25	\$14.47	\$13.81
L5615	2.5" X 12" 1M CARBON LEAD BLOCK	\$19.92	\$18.17	\$16.18	\$15.44
L5621	2.5" X 12" 10M CARBON BLOCK	\$14.45	\$13.18	\$11.74	\$11.20
L5633	2.5" X 12" T33 GAC	\$15.54	\$14.18	\$12.63	\$12.04
L5686	2.5" X 12" CAR/PHOSPHATE	\$16.36	\$14.93	\$13.30	\$12.68

Valved Head - Will Shut Off Water When Filter Is Removed

Part #	Description	CASE			
		1±	25±	125±	250±
L5-VH-JJ	1/4" FQC VALVED HEAD	\$13.75	\$12.55	\$11.17	\$10.66
L5-VH-KK	3/8" FQC VALVED HEAD	\$16.23	\$14.81	\$13.19	\$12.58

Non-Valved Head

Part #	Description	CASE			
		1±	25±	125±	250±
L5-NVH-JJ	1/4" FQC NON-VALVED HEAD	\$11.48	\$10.47	\$9.33	\$8.90
L5-NVH-KK	3/8" FQC NON-VALVED HEAD	\$13.56	\$12.37	\$11.02	\$10.51

L-Series Plastic Bracket

Part #	Description	CASE			
		1±	25±	125±	250±
L5-BRACKET	SINGLE BRACKET - PLASTIC	\$1.91	\$1.75	\$1.56	\$1.48



Housings / Filters



OMNIPURE® E SERIES FILTERS

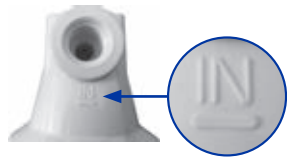

All Omnipure E, ELF & ELF XL filters can be ordered with the small bayonet "SB" at no extra charge. These will allow them to be used on all ELF DK7 Heads that have the underscore on the head by the inlet as well as the most popular Everpure heads on the market.



ELF DK7 head



E-Series replacement bodies are offered in 6", 8", 10", 12" and 14" lengths. Bodies are tested to withstand pressure of 125 psi and temperature of 100° F. Media service life is designed to handle up to 3,000 gallons in some models and filtration micron ratings are as low as 1 micron in other models.



E-Series Filters
(Everpure Compatible)

5 Mic. Sediment Filter

Part #	Description	CASE			
		1±	20±	100±	200±
E5305	2.5" X 6"	\$10.72	\$9.79	\$8.71	\$8.31
E5405	2.5" X 8"	\$12.31	\$11.23	\$10.00	\$9.54
E5505	2.5" X 10"	\$13.17	\$12.01	\$10.70	\$10.20
E5605	2.5" X 12"	\$14.49	\$13.22	\$11.77	\$11.23
E5705	2.5" X 14"	\$15.24	\$13.91	\$12.39	\$11.81

GAC

Part #	Description	CASE			
		1±	20±	100±	200±
E5328	2.5" X 6" T28	\$12.50	\$11.41	\$10.16	\$9.69
E5333	2.5" X 6" T33 ACID WASHED	\$13.28	\$12.12	\$10.79	\$10.30
E5428	2.5" X 8" T28	\$12.77	\$11.65	\$10.37	\$9.90
E5433	2.5" X 8" T33 ACID WASHED	\$13.75	\$12.55	\$11.17	\$10.66
E5528	2.5" X 10" T28	\$15.18	\$13.85	\$12.33	\$11.76
E5533	2.5" X 10" T33 ACID WASHED	\$15.75	\$14.37	\$12.80	\$12.21
E5628	2.5" X 12" T28	\$14.77	\$13.48	\$12.00	\$11.45
E5633	2.5" X 12" T33 ACID WASHED	\$15.01	\$13.69	\$12.19	\$11.63
E5728	2.5" X 14" T28	\$17.30	\$15.79	\$14.06	\$13.41
E5733	2.5" X 14" T33 ACID WASHED	\$18.14	\$16.56	\$14.74	\$14.06

GAC & Phosphate Scale Inhibitor

Part #	Description	CASE			
		1±	20±	100±	200±
E5386	2.5" X 6" GAC / PHOSPHATE 2 OZ	\$13.97	\$12.75	\$11.35	\$10.83
E5486	2.5" X 8" GAC / PHOSPHATE 2 OZ	\$13.85	\$12.64	\$11.26	\$10.74
E5586	2.5" X 10" GAC / PHOSPHATE 3 OZ	\$16.84	\$15.36	\$13.68	\$13.05
E5686	2.5" X 12" GAC / PHOSPHATE 4 OZ	\$17.72	\$16.17	\$14.40	\$13.73
E5786	2.5" X 14" GAC / PHOSPHATE 4 OZ	\$20.32	\$18.55	\$16.51	\$15.75

10 Mic. Carbon Block

Part #	Description	CASE			
		1±	20±	100±	200±
E5321	2.5" X 6"	\$14.53	\$13.26	\$11.81	\$11.26
E5421	2.5" X 8"	\$15.24	\$13.91	\$12.39	\$11.81
E5521	2.5" X 10"	\$17.01	\$15.52	\$13.82	\$13.18
E5621	2.5" X 12"	\$17.23	\$15.72	\$14.00	\$13.35
E5721	2.5" X 14"	\$27.09	\$24.72	\$22.01	\$21.00

1 Mic. Carbon Block

Part #	Description	CASE			
		1±	20±	100±	200±
E5320	2.5" X 6"	\$15.27	\$13.93	\$12.41	\$11.83
E5420	2.5" X 8"	\$16.08	\$14.68	\$13.07	\$12.47
E5520	2.5" X 10"	\$19.53	\$17.83	\$15.87	\$15.14
E5620	2.5" X 12"	\$20.30	\$18.52	\$16.49	\$15.73
E5720	2.5" X 14"	\$33.73	\$30.78	\$27.41	\$26.14

1 Mic. Carbon Block With Lead & Cyst. Reduction

Part #	Description	CASE			
		1±	20±	100±	200±
E5515	2.5" X 10"	\$21.91	\$19.99	\$17.80	\$16.98
E5615	2.5" X 12"	\$25.16	\$22.96	\$20.44	\$19.50
E5715	2.5" X 14"	\$38.49	\$35.12	\$31.27	\$29.83

10 Mic. Carbon Block With Scale Inhibitor

Part #	Description	CASE			
		1±	20±	100±	200±
E5321-P	2.5" X 6" 10 MIC. CARBON BLK./ PHOS.	\$16.16	\$14.75	\$13.13	\$12.52
E5421-P	2.5" X 8" 10 MIC. CARBON BLK./ PHOS.	\$17.38	\$15.86	\$14.12	\$13.47
E5521-P	2.5" X 10" 10 MIC. CARBON BLK./PHOS.	\$19.30	\$17.61	\$15.68	\$14.96
E5621-P	2.5" X 12" 10 MIC. CARBON BLK./PHOS.	\$19.53	\$17.83	\$15.87	\$15.14
E5721-P	2.5" X 14" 10 MIC. CARBON BLK./PHOS.	\$30.81	\$28.12	\$25.04	\$23.88

Housings / Filters



Good Water Warehouse, Inc.

CANADASALES@GOODWATERWAREHOUSE.COM
GOODWATERWAREHOUSE.COM

PRICES ARE USD FOB
CALGARY/NEWMARKET

ALBERTA

TEL: (403) 252-7972
TEL: (888) 668-1234
FAX: (888) 227-3291

ONTARIO

TEL: (905) 868-9287
TEL: (888) 868-9287
FAX: (905) 830-0512



E-Series Filters
(Everpure Compatible)



1 Mic. Carbon Block with Scale Inhibitor

Part #	Description	CASE			
		1±	20±	100±	200±
E5320-P	2.5" X 6" 1 OZ PHOSPHATE	\$16.91	\$15.43	\$13.74	\$13.11
E5420-P	2.5" X 8" 1 OZ PHOSPHATE	\$17.87	\$16.31	\$14.52	\$13.85
E5520-P	2.5" X 10" 2 OZ PHOSPHATE	\$21.82	\$19.91	\$17.73	\$16.91
E5620-P	2.5" X 12" 3 OZ PHOSPHATE	\$22.58	\$20.60	\$18.35	\$17.50
E5720-P	2.5" X 14" 4 OZ PHOSPHATE	\$37.46	\$34.18	\$30.44	\$29.03

1 Mic. Carbon Block with Scale Inhibitor, Lead & Cyst. Reduction

Part #	Description	CASE			
		1±	20±	100±	200±
E5415-P	2.5" X 8"	\$24.66	\$22.50	\$20.03	\$19.11
E5515-P	2.5" X 10"	\$23.76	\$21.68	\$19.30	\$18.41
E5615-P	2.5" X 12"	\$27.34	\$24.95	\$22.22	\$21.19
E5715-P	2.5" X 14"	\$42.18	\$38.49	\$34.28	\$32.69

ALL Phosphate

Part #	Description	CASE			
		1±	20±	100±	200±
E5385	2.5" X 6"	\$21.32	\$19.45	\$17.32	\$16.52
E5485	2.5" X 8"	\$28.18	\$25.71	\$22.89	\$21.84
E5585	2.5" X 10"	\$32.64	\$29.79	\$26.52	\$25.30
E5685	2.5" X 12"	\$37.30	\$34.04	\$30.31	\$28.91
E5785	2.5" X 14"	\$42.16	\$38.47	\$34.26	\$32.67

DI Mix Bed

Part #	Description	CASE			
		1±	20±	100±	200±
E5455	2.5" X 8"	\$20.71	\$18.90	\$16.83	\$16.05
E5555	2.5" X 10"	\$23.64	\$21.57	\$19.21	\$18.32
E5655	2.5" X 12"	\$24.37	\$22.24	\$19.80	\$18.89

Filter Heads

Part #	Description	CASE			
		1±	20±	100±	200±
ELF DK7 HEAD	ELF NON VALVE 3/8" FPT DK7	\$9.83	\$8.97	\$7.99	\$7.62
ELF VALVE HEAD P4	ELF VALVED HEAD P4; 1/4" JG	\$17.69	\$16.15	\$14.38	\$13.71
ELF VALVED HEAD P6 DK7	ELF VALVED HEAD P6; 3/8" JG	\$20.65	\$18.85	\$16.78	\$16.01
ELF NON VALVED P6 DK7	ELF NON VALVE HEAD P6; 3/8" JG	\$15.73	\$14.35	\$12.78	\$12.19

Brackets

Part #	Description	CASE			
		1±	10±	50±	100±
ELF BRACKET	E & Q BRACKET [PLASTIC] W/SCREWS	\$2.48	\$2.26	\$2.02	\$1.92
ELF BRACKET-P HEAD	ELF Metal Bracket for Valved Heads w/Screws	\$4.47	\$4.08	\$3.64	\$3.47

Housings / Filters



OMNIPURE® ELF SERIES FILTERS



All Omnipure E, ELF & ELF XL filters can be ordered with the small bayonet "SB" at no extra charge. These will allow them to be used on all ELF DK7 Heads that have the underscore on the head by the inlet as well as the most popular Everpure heads on the market.



(ELF BRACKET-P HEAD)



Example Installation
(ELF BRACKET-P HEAD)

ELF Filters (Large Format)

Part #	Description	CASE			
		1±	12±	60±	120±
ELF 1M	4" X 12.5" 1M CARBON BLOCK	\$24.36	\$22.23	\$19.79	\$18.88
ELF 1ML	4" X 12.5" 1M LEAD REDUCTION	\$26.72	\$24.38	\$21.71	\$20.71
ELF 1ML-KDF	4" X 12.5" 1M BLOCK / KDF-55/ LEAD RED.	\$26.64	\$24.31	\$21.65	\$20.65
ELF 1ML-AM	4" X 12.5" 1M ALGION ANTIMICROBIAL	\$38.81	\$35.41	\$31.53	\$30.08
ELF 1M-KDF	4" X 12.5" 1M BLOCK W/KDF	\$26.57	\$24.25	\$21.59	\$20.60
ELF 1M-P	4" X 12.5" 1M CARBON BK W/PHOS	\$26.80	\$24.46	\$21.78	\$20.77
ELF 1M-P KDF	4" X 12.5" 1M CARBON BK W/PHOS & KDF	\$29.29	\$26.72	\$23.80	\$22.70
ELF 1ML-P	4" X 12.5" 1M LEAD BLOCK W/PHOSPHATE	\$28.80	\$26.28	\$23.40	\$22.32
ELF 1ML-SILVER	4" X 12.5" 1M LEAD BLOCK; SILVER IMP.	\$31.13	\$28.40	\$25.29	\$24.12
ELF 5M	4" X 12.5" 5M CARBON BLOCK	\$21.10	\$19.26	\$17.15	\$16.36
ELF 5M-KDF-P	4" X 12.5" 5M CARBON BK W KDF/PHOS	\$26.00	\$23.73	\$21.13	\$20.15
ELF 5M-P	4" X 12.5" 5M CARBON BK W/PHOS	\$22.58	\$20.60	\$18.35	\$17.50
ELF 5MSED	4" X 12.5" 5M SEDIMENT FILTER	\$17.58	\$16.04	\$14.28	\$13.62
ELF 10M	4" X 12.5" 10M CARBON BLOCK	\$21.53	\$19.64	\$17.49	\$16.68
ELF 10M-P	4" X 12.5" 10M CARBON BK W/PHOS	\$22.58	\$20.60	\$18.35	\$17.50
ELF C-249	4" X 12.5" ALL C-249 RESIN	\$23.71	\$21.63	\$19.26	\$18.37
ELF PHOS	4" X 12.5" ALL PHOSPHATE	\$77.38	\$70.61	\$62.88	\$59.97
ELF T40	4" X 12.5" COCONUT GAC-T40	\$20.08	\$18.32	\$16.31	\$15.56
ELF 1M-P-W	4" X 12.5" 1M CAR BK W/PHOS & SED WRAP	\$28.30	\$25.83	\$23.00	\$21.94
ELF 1M-SILVER	4" X 12.5" 1M CARBON BLOCK; SILVER IMP.	\$30.80	\$28.10	\$25.02	\$23.87

Filter Heads

Part #	Description	CASE			
		1±	20±	100±	200±
ELF DK7 HEAD	ELF NON VALVE 3/8" FPT DK7	\$9.83	\$8.97	\$7.99	\$7.62
ELF VALVE HEAD P4	ELF VALVED HEAD P4; 1/4" JG	\$17.69	\$16.15	\$14.38	\$13.71
ELF VALVED HEAD P6 DK7	ELF VALVED HEAD P6; 3/8" JG	\$20.65	\$18.85	\$16.78	\$16.01
ELF NON VALVED P6 DK7	ELF NON VALVE HEAD P6; 3/8" JG	\$15.73	\$14.35	\$12.78	\$12.19

Brackets

Part #	Description	CASE			
		1±	10±	50±	100±
ELF BRACKET	E & Q BRACKET [PLASTIC] W/SCREWS	\$2.48	\$2.26	\$2.02	\$1.92
ELF BRACKET-P HEAD	ELF Metal Bracket for Valved Heads w/Screws	\$4.47	\$4.08	\$3.64	\$3.47

Housings / Filters



OMNIPURE® ELF XL SERIES FILTERS

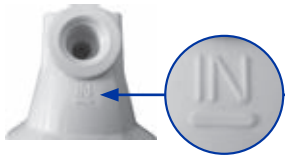

All Omnipure E, ELF & ELF XL filters can be ordered with the small bayonet "SB" at no extra charge. These will allow them to be used on all ELF DK7 Heads that have the underscore on the head by the inlet as well as the most popular Everpure heads on the market.

ELF XL Filters

Part #	Description	CASE			
		1±	6±	30±	60±
ELF XL .5M	4" X 15" .5M CARBON BLOCK	\$33.60	\$30.66	\$27.30	\$26.04
ELF XL 1M	4" X 15" 1M CARBON BLOCK	\$33.60	\$30.66	\$27.30	\$26.04
ELF XL 1M-P	4" X 15" 1M CARBON BLOCK W/PHOS.	\$36.05	\$32.90	\$29.29	\$27.94
ELF XL 1M-AM	4" X 15" 1M CARBON B. W/ ANTIBACTERIAL	\$43.47	\$39.67	\$35.32	\$33.69
ELF XL 1ML	4" X 15" 1M LEAD BLOCK	\$38.97	\$35.56	\$31.66	\$30.20
ELF XL 1ML-KDF	4" X 15" 1M LEAD BLOCK W/KDF; H-300	\$40.69	\$37.13	\$33.06	\$31.54
ELF XL 1ML-P	4" X 15" 1M LEAD BLOCK W/PHOS. H-104	\$44.93	\$41.00	\$36.51	\$34.82
ELF XL CHLORBLOCK	4" X 15" 1M CHLORAMINE BLOCK	\$35.79	\$32.66	\$29.08	\$27.74
ELF XL 5M	4" X 15" 5M CARBON BLOCK	\$25.11	\$22.91	\$20.40	\$19.46
ELF XL 5M-P	4" X 15" 5M CARBON BLOCK W/PHOS.	\$32.04	\$29.24	\$26.04	\$24.83
ELFXL5MSED	4 X 15" 5M SED/ ELF SERIES	\$21.83	\$19.92	\$17.74	\$16.92
ELF XL 10M	4" X 15" 10M CARBON BLOCK	\$28.16	\$25.70	\$22.88	\$21.82
ELF XL 10M-P	4" X 15" 10M CARBON BLOCK W/PHOS.	\$32.03	\$29.23	\$26.03	\$24.83
ELF XL NRW-37	4" X 15" 100% NRW-37 RESIN	\$50.38	\$45.97	\$40.93	\$39.04
ELFXL-1/2-C249-1/2GAC	4" X 15" ELFXL 1/2 C-249 1/2 GAC	\$26.93	\$24.57	\$21.88	\$20.87
ELF XL T40	4" X 15" T40 COCO GAC FILTER	\$20.53	\$18.73	\$16.68	\$15.91

Filter Heads

Part #	Description	CASE			
		1±	20±	100±	200±
ELF DK7 HEAD	ELF NON VALVE 3/8" FPT DK7	\$9.83	\$8.97	\$7.99	\$7.62
ELF VALVE HEAD P4	ELF VALVED HEAD P4; 1/4" JG	\$17.69	\$16.15	\$14.38	\$13.71
ELF VALVED HEAD P6 DK7	ELF VALVED HEAD P6; 3/8" JG	\$20.65	\$18.85	\$16.78	\$16.01
ELF NON VALVED P6 DK7	ELF NON VALVED HEAD P6; 3/8" JG	\$15.73	\$14.35	\$12.78	\$12.19

Brackets

Part #	Description	CASE			
		1±	10±	50±	100±
ELF BRACKET	E & Q BRACKET [PLASTIC] W/SCREWS	\$2.48	\$2.26	\$2.02	\$1.92
ELF BRACKET-P HEAD	ELF Metal Bracket for Valved Heads w/Screws	\$4.47	\$4.08	\$3.64	\$3.47

(ELF BRACKET-P HEAD)

OMNIPURE® ELF EXT CAP SERIES FILTERS



These will fit most popular Everpure heads on the market along with DK7 Heads that have the underscore.

EXT ELF Cap Filters

Part #	Description	CASE			
		1±	12±	60±	120±
ELF EXT 1M-P	ELF EXT CAP-1 M C/B W/ PHOS. (SM. BAYONET)	\$36.44	\$33.26	\$29.61	\$28.24
ELF EXT 1ML-SMS	EXT SB 1M LEAD BLOCK; 2X SMS WRAP	\$35.05	\$31.99	\$28.48	\$27.17
ELF EXT 5M	ELF EXT CAP-5 M C/B (SMALL BAYONET)	\$26.72	\$24.38	\$21.71	\$20.71
ELF EXT 5M-P	ELF EXT CAP-5 M C/B W/PHOS. (SM. BAYONET)	\$31.62	\$28.85	\$25.69	\$24.51
ELF EXT 10ML-SMS	EXT SB 10M LEAD BLOCK; 2X SMS WRAP	\$33.91	\$30.94	\$27.55	\$26.28

Part #	Description	CASE			
		1±	6±	30±	60±
ELF EXT CAP 10M WRAP	10 M CARBON BLOCK	\$31.80	\$29.01	\$25.84	\$24.64
ELF EXT CAP 10M-P WRAP	10 M CARBON BLOCK W/ PHOSPHATE	\$40.02	\$36.52	\$32.52	\$31.02

Part #	Description	CASE			
		1±	12±	60±	120±
ELF EXT XE DK7	ELF EXT 4"X12" SB EMPTY; NO MEDIA VESSEL	\$13.62	\$12.42	\$11.06	\$10.55

Filter Heads

Part #	Description	CASE			
		1±	20±	100±	200±
ELF DK7 HEAD	ELF NON VALVE 3/8" FPT DK7	\$9.83	\$8.97	\$7.99	\$7.62
ELF VALVE HEAD P4	ELF VALVED HEAD P4; 1/4" JG	\$17.69	\$16.15	\$14.38	\$13.71
ELF VALVED HEAD P6 DK7	ELF VALVED HEAD P6; 3/8" JG	\$20.65	\$18.85	\$16.78	\$16.01
ELF NON VALVED P6 DK7	ELF NON VALVE HEAD P6; 3/8" JG	\$15.73	\$14.35	\$12.78	\$12.19

Brackets

Part #	Description	CASE			
		1±	10±	50±	100±
ELF BRACKET	E & Q BRACKET [PLASTIC] W/SCREWS	\$2.48	\$2.26	\$2.02	\$1.92
ELF BRACKET-P HEAD	ELF Metal Bracket for Valved Heads w/Screws	\$4.47	\$4.08	\$3.64	\$3.47





ALKALINE FILTERS



This true Alkaline filter offers premium filtration medias that emit Far Infrared Rays, increases pH, and will give your water a refreshing mineral flavor!

Alkaline Filters

Part #	Description	CASE			
		1±	25±	125±	
ALKALINE-2510	2.5" X 9 3/4" ALKALINE FILTER; 0.5 GPM; 1000 GAL	\$69.98	\$65.32	\$60.65	
ALKALINE-INLINE	2.5" X 12" ALKALINE INLINE; 1/4 FPT; 0.5 GPM; 1000GAL	\$81.13	\$75.72	\$70.31	
Part #	Description	1±	20±	100±	
QMPC300-ALK	2.5" X 10" ALKALINE CARTRIDGE	\$127.83	\$119.31	\$110.79	
Part #	Description	1±	9±	45±	90±
QMPALKA20	2.5" X 20" ALKALINE CARTRIDGE	\$321.39	\$300.52	\$288.00	\$267.13
Part #	Description	1±	6±	30±	60±
QMPALKA10BB	10" BB ALAKLINE CARTRIDGE	\$312.45	\$292.17	\$279.99	\$259.70
QMPALKA20BB	20" BB ALAKLINE CARTRIDGE	\$550.94	\$515.16	\$493.70	\$457.92

Housings / Filters

RESINTECH® SPECIALTY FILTERS



2.5" x 10" Speciality Filters



ResinTech® Specialty Filters

Part #	Description	1±	12±	60±
AF-10-2010	1/2 LB KDF/GAC CARTRIDGE	\$30.67	\$28.12	\$25.56
AF-10-2011	1 LB KDF/GAC CARTRIDGE	\$44.60	\$40.88	\$37.17
AF-10-2115	1.5 LB KDF/GAC CARTRIDGE	\$53.56	\$49.10	\$44.64
AF-10-2125	2.5 LB KDF/GAC CARTRIDGE	\$68.86	\$63.13	\$57.39
AF-10-2013	3.0 LB KDF/GAC	\$67.66	\$62.02	\$56.39
AF-10-2014	4.0 LB KDF/COCO GAC	\$95.12	\$87.19	\$79.27
AF-10-2210	1/2 LB KDF-85/GAC	\$33.20	\$30.43	\$27.67
AF-10-2211	1 LB KDF-85/GAC	\$48.84	\$44.77	\$40.70
AF-10-2025	2.5 LB ALL KDF CARTRIDGE	\$65.24	\$59.80	\$54.37
AF-10-2054	4 LB ALL KDF CARTRIDGE	\$90.21	\$82.69	\$75.17
AF-10-3310	1 LB PHOSPHATE/GAC	\$37.72	\$34.58	\$31.43
AF-10-3328	1 LB PHOSPHATE CARTRIDGE	\$27.79	\$25.48	\$23.16
AF-10-3321	1.5 LB PHOSPHATE	\$45.98	\$42.14	\$38.31
AF-10-3322	2 LB PHOSPHATE	\$38.74	\$35.52	\$32.29
AF-10-3231	100% CALCITE CARTRIDGE	\$13.02	\$11.93	\$10.85
AF-10-4209	50% CALCITE/50% GAC	\$16.73	\$15.34	\$13.94
AF-10-3232	50% CALCITE/50% COROSEX	\$13.73	\$12.59	\$11.44
AF-10-3690	ACTIVATED ALUMINA CARTRIDGE	\$41.59	\$38.12	\$34.66
AF-10-3695	ARSENIC REMOVAL CARTRIDGE	\$87.37	\$80.09	\$72.81
AF-10-1053	CENTAUR; H2S REMOVAL CARTRIDGE	\$31.76	\$29.11	\$26.47
AF-10-4030	DI MIX BED 3; COLOR CHANGE	\$38.36	\$35.16	\$31.96
AF-10-4010	DI MIX BED CARTRIDGE; CLEAR	\$34.25	\$31.40	\$28.55
AF-10-3400	MANGANESE GREENSAND CARTRIDGE	\$26.16	\$23.98	\$21.80
AF-10-3610	NITRATE REMOVAL CARTRIDGE	\$44.14	\$40.46	\$36.78
AF-10-3621	ORGANIC/TANNIN CARTRIDGE	\$45.89	\$42.07	\$38.24
AF-10-4080	PREMIUM: TASTE/ODOR/HEAVY METAL	\$31.26	\$28.66	\$26.05
AF-10-3003	SOFTENING CARTRIDGE	\$20.24	\$18.56	\$16.87



4.5" x 10" BB Speciality Filters



ResinTech® Specialty Filters

Part #	Description	1+	8+	40+
AF-10-2115-BB	1.5 LB KDF/GAC CARTRIDGE	\$59.55	\$54.59	\$49.62
AF-10-2013-BB	3 LB KDF/GAC CARTRIDGE	\$99.11	\$90.85	\$82.59
AF-10-2015-BB	5 LB KDF/GAC CARTRIDGE	\$129.64	\$118.84	\$108.03
AF-10-2212-BB	2 LB KDF-85/COCO GAC	\$96.60	\$88.55	\$80.50
AF-10-2213-BB	3 LB KDF-85/GAC	\$102.10	\$93.59	\$85.08
AF-10-3314-BB	4 LB ALL PHOSPHATE	\$73.18	\$67.08	\$60.99
AF-10-2055-BB	5 LB ALL KDF CARTRIDGE	\$224.42	\$205.72	\$187.02
AF-10-2060-BB	10 LB ALL KDF CARTRIDGE	\$223.16	\$204.57	\$185.97
AF-10-3231-BB	100% CALCITE CARTRIDGE	\$34.49	\$31.62	\$28.74
AF-10-3232-BB	50% CALCITE/50% COROSEX	\$34.46	\$31.59	\$28.72
AF-10-3690-BB	ACTIVATED ALUMINA CARTRIDGE	\$94.81	\$86.91	\$79.01
AF-10-3695-BB	ARSENIC REMOVAL CARTRIDGE	\$193.29	\$177.18	\$161.07
AF-10-1042-BB	CATALYTIC CARBON	\$63.46	\$58.17	\$52.88
AF-10-4000-BB	DI MIX BED DRINKING CARTRIDGE	\$70.82	\$64.92	\$59.02
AF-10-4010-BB	DI MIXBED 2 CARTRIDGE	\$73.52	\$67.39	\$61.27
AF-10-1046-BB	GAC CARTRIDGE	\$38.16	\$34.98	\$31.80
AF-10-3610-BB	NITRATE SELECTIVE FILTER	\$103.39	\$94.77	\$86.16
AF-10-3621-BB	ORGANIC/TANNIN	\$105.58	\$96.78	\$87.98
AF-10-4080-BB	PREMIUM; TASTE/ODOR/HEAVY METAL	\$73.06	\$66.97	\$60.89
AF-10-3003-BB	SOFTENING CARTRIDGE	\$46.61	\$42.73	\$38.84

2.5" x 20" Speciality Filters

Part #	Description	1+	9+	45+
AF-20-2011	1 LB KDF/GAC CARTRIDGE	\$55.83	\$51.18	\$46.53
AF-20-2125	2.5 LB KDF/GAC CARTRIDGE	\$78.60	\$72.05	\$65.50
AF-20-2115	1.5 LB KDF CARTRIDGE	\$45.46	\$41.67	\$37.88
AF-20-2211	1 LB KDF-85/GAC	\$54.54	\$49.99	\$45.45
AF-20-2212	2 LB KDF-85/GAC	\$87.04	\$79.79	\$72.54
AF-20-2014	4 LB KDF CARTRIDGE	\$118.86	\$108.96	\$99.05
AF-20-3310	1 LB. PHOSPHATE/GAC	\$54.64	\$50.08	\$45.53
AF-20-3314	4 LB ALL PHOSPHATE	\$78.91	\$72.33	\$65.76
AF-20-3231	100% CALCITE CARTRIDGE	\$24.90	\$22.83	\$20.75
AF-20-3232	50% CALCITE/50% COROSEX	\$27.61	\$25.31	\$23.01
AF-20-3690	ACTIVATED ALUMINA CARTRIDGE	\$84.31	\$77.28	\$70.26
AF-20-3695	ARSENIC REMOVAL CARTRIDGE	\$183.17	\$167.91	\$152.64
AF-20-4000	DI 4 MIXBED/GAC CARTRIDGE	\$58.03	\$53.19	\$48.36
AF-20-4010	DI MIXED BED CARTRIDGE; BLUE	\$65.11	\$59.69	\$54.26
AF-20-3610	NITRATE SELECTIVE FILTER	\$86.47	\$79.26	\$72.06
AF-20-3621	ORGANIC TANNIN REMOVAL CART	\$94.78	\$86.88	\$78.99
AF-20-4080	PREMIUM: TASTE/ODOR/HEAVY METAL	\$62.36	\$57.16	\$51.97
AF-20-3003	SOFTENING CARTRIDGE	\$32.49	\$29.78	\$27.08

4.5" x 20" BB Speciality Filters

Part #	Description	1+	4+	20+
AF-20-2011-BB	1 LB KDF/GAC CARTRIDGE	\$82.86	\$75.95	\$69.05
AF-20-2115-BB	1.5 LB KDF/GAC CARTRIDGE	\$89.17	\$81.74	\$74.31
AF-20-2212-BB	2 LB KDF-85/GAC	\$126.72	\$116.16	\$105.60
AF-20-2125-BB	2.5 LB KDF-55/GAC	\$104.18	\$95.49	\$86.81
AF-20-2215-BB	5 LB KDF-85/GAC	\$185.16	\$169.73	\$154.30
AF-20-2014-BB	4 LB KDF/GAC CARTRIDGE	\$118.22	\$108.37	\$98.52
AF-20-2015-BB	5 LB KDF/GAC CARTRIDGE	\$128.24	\$117.56	\$106.87
AF-20-3318-BB	8 LB ALL PHOSPHATE	\$134.04	\$122.87	\$111.70
AF-20-3231-BB	100% CALCITE	\$60.28	\$55.26	\$50.23
AF-20-3232-BB	50% CALCITE/ 50% COROSEX	\$64.06	\$58.72	\$53.39
AF-20-3690-BB	ACTIVATED ALUMINA	\$186.74	\$171.18	\$155.62
AF-20-3695-BB	ARSENIC REMOVAL CARTRIDGE	\$404.05	\$370.38	\$336.71
AF-20-1042-BB	CATALYTIC CARBON	\$130.70	\$119.81	\$108.91
AF-20-1046-BB	COCO GAC	\$83.34	\$76.40	\$69.45



PENTAIR® SPECIALTY FILTERS



PENTEK

The PCC-1 cartridge is designed to fit in: #10 Standard filters only.

The PPC212 cartridge is designed to fit: PENTEK® #10 Standard or Slim Line® filter housings.

10" Deionization PCF1-10MB (155273-43)



20" Big Blue® Iron Reduction RFFE20-BB (155263-43)



In-Line Filter

10" Poly Phosphate Crystals - Scale Inhibitor

Part #	Description	1±	6±	30±	60±
155100-43	PCC-1 PHOSPHATE CRYSTAL CART.	\$82.88	\$70.04	\$64.20	\$58.36
155248-43	PPC212 PHOSPHATE CART.(12 OZ)	\$33.78	\$28.55	\$26.17	\$23.79

Chloramine Reduction Carbon Cartridges

Part #	Description	1±	12±	60±	120±
255416-43	CHLORPLUS 10 CARBON BLOCK (10" x 2.5")	\$30.98	\$26.18	\$24.00	\$21.82
255417-43	CHLORPLUS 20 CARBON BLOCK (20" x 2.5")	\$60.75	\$51.34	\$47.06	\$42.78
355752-43	CHLORPLUS-BB CARBON BLOCK (10"BB)	\$95.12	\$80.38	\$73.68	\$66.98
355753-43	CHLORPLUS 20BB CARBON BLOCK (20"BB)	\$197.69	\$167.06	\$153.14	\$139.22

Water Softening

Part #	Description	1±	4±	20±	40±
155321-43	WS-20BB SOFTENER RESIN CART	\$82.51	\$69.73	\$63.92	\$58.11

Deionization

Part #	Description	1±	6±	30±	60±
155273-43	PCF1-10MB FDA D.I. RESIN (10")	\$44.88	\$37.92	\$34.76	\$31.60
155274-43	PCF1-20MB; FDA D.I. RESIN (20")	\$78.96	\$66.73	\$61.17	\$55.61
155281-43	BBF1-20MB FDA DI RESIN (20"BB)	\$207.42	\$175.28	\$160.68	\$146.07

Big Blue® Iron Reduction

Part #	Description	1±	8±	40±	80±
655005-43	RFFE10-BB RADIAL FLOW IRON RED	\$94.39	\$79.77	\$73.12	\$66.47
155263-43	RFFE20-BB; RADIAL FLOW IRON RED	\$139.95	\$118.26	\$108.41	\$98.55

Big Blue® Oil Absorbing Cartridge

Part #	Description	1±	48±	240±	480±
155656-06	IC-101L; ICEMAKER FILTER	\$13.80	\$11.66	\$10.69	\$9.72

In-Line Filter

Part #	Description	1±	48±	240±	480±
155656-06	IC-101L; ICEMAKER FILTER	\$13.80	\$11.66	\$10.69	\$9.72

Housings / Filters

EMPTY REFILLABLE CARTRIDGES

Empty Refillable Cartridges

Part #	Description	1±	50±	250±
ECIN-2010-C	2" x 10" EMPTY CART.; CLEAR INLINE	\$3.98	\$3.71	\$3.45
ECIN-2010-W	2" x 10" INLINE SHELL; WHITE W/PAD	\$3.33	\$3.11	\$2.89
RC-W-975-50	2.5" x 10" EMPTY CART.; WHITE/WHITE (FI-EC10W)	\$5.70	\$5.32	\$4.94
RC-C-20	2.5" x 20" EMPTY CLEAR	\$16.06	\$14.99	\$13.92
RC-C-BB-975	4.5" x 10"BB EMPTY CLEAR	\$15.40	\$14.38	\$13.35
RC-C-BB-20	4.5" x 20"BB EMPTY CLEAR	\$27.31	\$25.49	\$23.67
RC-W-BB-20	4.5" x 20"BB EMPTY WHITE	\$26.69	\$24.91	\$23.13





CULLIGAN COMPATIBLE FILTERS



Culligan® Pre-Filter
(RS-23-SED5)

Culligan Compatible Filters (Fits All AC & H Series Units)

Part #	Description	1±	25±	125±	250±
FXCUL12CL2	CULLIGAN 10UM CARBON BLOCK	\$7.26	\$6.11	\$4.97	\$4.58
SC1215105	PRE-FILTER; 5 MIC.	\$6.03	\$4.33	\$4.08	\$3.91
SC1216110	PRE-CARBON; COCONUT CARBON BLOCK	\$7.53	\$5.41	\$5.09	\$4.88

CASE



Culligan® Pre-Carbon Block
(32-175-050-100)

Part #	Description	1±	36±	180±	360±
RS-23-SED5	PRE-FILTER; 5 MIC.	\$3.74	\$3.41	\$3.04	\$2.90
32-175-050-100	PRE-CARBON; CARBON BLOCK	\$7.26	\$6.63	\$5.90	\$5.63



Culligan® GAC Pre-Carbon
(S7025-C)

Part #	Description	1±	50±	250±	500±
CL6ROT40-B	POST CARBON; 2" X 6" T40 GAC; 1/4" FPT	\$7.10	\$6.48	\$5.77	\$5.51
CL6ROT40-C	POST CARBON; 2" X 6" T40 GAC; 3/8" FPT	\$7.10	\$6.48	\$5.77	\$5.51
K2340-JJ	POST CARBON; 2" X 6" T40 GAC; 1/4" FQC	\$8.67	\$7.91	\$7.05	\$6.72
K2340-KK	POST CARBON; 2" X 6" T40 GAC; 3/8" FQC	\$9.55	\$8.72	\$7.76	\$7.41



Culligan® Post Carbon GAC
(CL6ROT40-B)

Culligan Compatible - Membrane Elements, Dry

Part #	Description	1±	25±	125±
ACT-36	CULLIGAN TFM-36 [FITS H8/83 AC15, AC30]	\$28.84	\$26.92	\$25.00
ACT-50	CULLIGAN TFM-50 [FITS H8/83 AC15, AC30]	\$29.82	\$27.83	\$25.84

CASE

Housings / Filters

ECO WATER COMPATIBLE FILTER



Eco Water Compatible

Eco Water Compatible Filter

Part #	Description	1±	25±	250±	625±
FXWF-1000	ECOWATER/KENMORE COMPATIBLE	\$7.37	\$6.45	\$5.99	\$5.53

CASE

HYDROTECH ORIGINAL & COMPATIBLE FILTERS



Hydrotech® Pre-Filter
(RS-22-SED5)

Hydrotech & Microline [Clack] Compatible Filters

Part #	Description	1±	25±	125±	250±
FXHTC11CL2	HYDROTECH/CLACK 10UM CARBON BLOCK	\$7.20	\$5.76	\$4.68	\$4.32
SC1115105	PRE-FILTER; 5 MIC	\$4.16	\$3.69	\$3.38	\$3.23
SC1116110	PRE & POST; COCONUT CARBON BLOCK	\$9.04	\$6.49	\$6.11	\$5.86

CASE



Hydrotech® Pre & Post
Carbon Block
(RS-22-CB5-EB)

Part #	Description	1±	36±	180±	360±
RS-22-SED5	PRE-FILTER; 5 MIC	\$3.73	\$3.40	\$3.03	\$2.89
RS-22-CB5-EB	PRE & POST; CARBON BLOCK	\$7.60	\$6.94	\$6.18	\$5.89

CASE



Hydrotech® Filter
(414-000-08)

Hydrotech Original Filters

Part #	Description	1±	50±	250±
414-000-08	HYDROTECH SEDIMENT FILTER	\$7.23	\$6.75	\$6.27

CASE



Hydrotech® Membrane
(33001068)

Part #	Description	1±	50±	100±
414-000-09	HYDROTECH CARBON BLOCK FILTER	\$19.82	\$18.50	\$17.18

CASE

Hydrotech Original Membranes

Part #	Description	1±	10±	25±	50±
414-000-02	15 GPD CTA	\$122.48	\$116.12	\$109.76	\$101.81
414-000-04	15 GPD TFC	\$122.48	\$116.12	\$109.76	\$101.81
33001068	25 GPD TFC	\$72.54	\$68.77	\$65.00	\$60.29
414-000-06	36 GPD TFC	\$65.13	\$61.75	\$58.36	\$54.13
33001033	50 GPD TFC	\$83.01	\$78.70	\$74.39	\$69.00

CASE



MERLIN ORIGINAL FILTERS



(3038333)

Merlin Filters

Part # 1266690 **Description** MERLIN 10um SEDIMENT PREFILTER

CASE		
1+	15+	75+
\$18.10	\$16.90	\$15.69



(FX17CL2)

Part # 3038333 **Description** REPLACEMENT CARBON PREFILTER

1+	20+	100+
\$50.10	\$46.76	\$43.42



(4000569)

Part # FX17CL2 **Description** MERLIN GREEN BLOCK 2.5"X 17" 10UM

1+	25+	125+	250+
\$19.67	\$17.21	\$15.98	\$14.75



(255526-43)

Part # 4000569 **Description** REPLACEMENT MEMBRANE ELEMENT

1+	8+	40+	80+
\$156.44	\$146.66	\$136.88	\$127.11

MICROLINE ORIGINAL FILTERS



(S-7011)

Microline Original Filters

Part # S-7011 **Description** 5MIC SED. FILTER

CASE			
1+	24+	120+	240+
\$4.10	\$3.81	\$3.63	\$3.34



(S-7025)

Part # S-7025 **Description** GAC FILTER

\$18.48	\$17.52	\$16.56	\$15.36
---------	---------	---------	---------



(S-7028)

Part # S-7028 **Description** CARBON BLOCK FILTER

\$14.78	\$13.75	\$13.09	\$12.05
---------	---------	---------	---------

Microline Original Membranes



(S-1224RS)

Part # S-1224RS **Description** 14 GPD CTA
Part # S-1227RS **Description** 25 GPD TFC
Part # S-1229RS **Description** 50 GPD TFC

CASE			
1+	10+	25+	50+
\$58.67	\$52.23	\$49.17	\$46.80
\$52.07	\$46.35	\$43.64	\$41.53
\$51.34	\$48.67	\$46.00	\$42.67

PUROTWIST FILTERS



(Q5605)

PuROTwist Filters

Part # Q5605 **Description** 12" 5 MICRON
Part # Q5640 **Description** 12" T40 COCONUT GAC
Part # TQ56-36FC/NSF **Description** Q TFC 36 GPD NSF ENC. MEMBRANE W/ FC

CASE			
1+	25+	125+	250+
\$12.72	\$11.60	\$10.33	\$9.86
\$14.24	\$13.00	\$11.57	\$11.04
\$44.06	\$41.12	\$38.18	

Part # TQ56-50FC **Description** Q TFC 50 GPD ENC. MEMBRANE W/550 ML FC

1+	25+	125+
\$52.09	\$48.62	\$45.15

RAINSOFT COMPATIBLE FILTERS



Rainsoft Compatible Filter
(32-250-10-MATRIKX(R))

Rainsoft Compatible Filters

Part # 32-250-10-MATRIKX(R) **Description** 10" x 2.5" Matrikx® CTO 5 MIC. Chlor. Taste/Odor

CASE			
1+	20+	100+	200+
\$3.77	\$3.25	\$3.06	\$2.92

Part # CL6ROT40-B **Description** POST CARBON;2"X6" T33 GAC;1/4" FPT(9798)

1+	50+	250+	500+
\$7.10	\$6.48	\$5.77	\$5.51

Rainsoft Compatible Membranes



Rainsoft Compatible
(TFC-RS9-12)

Part # TFC-RS9-12 **Description** TFC 12 GPD (FITS;9565, 9591, 9594, 13016)
Part # TFC-RS9-22 **Description** TFC 22 GPD (FITS;9568, 9596)
Part # TFC-RS9-36 **Description** TFC 36 GPD
Part # TFC-RS9-50 **Description** TFC 50 GPD

CASE		
1+	25+	125+
\$26.50	\$24.74	\$22.97
\$30.53	\$28.49	\$26.46
\$31.15	\$29.08	\$27.00
\$32.79	\$30.61	\$28.42



WATER FACTORY/CUNO SQC ORIGINAL & COMPATIBLE FILTERS



CUNO® SQC Series
(PSQC-1)

Water Factory / CUNO SQC Series Compatible Filters

Part #	Description	CASE			
		1±	6±	30±	60±
PSQC-1	SEDIMENT PREFILTER	\$18.18	\$17.04	\$15.91	\$14.77
PSQC-2	SED/CARB PREFILTER	\$18.69	\$17.53	\$16.36	\$15.19
PSQC-3	GAC CARBON FILTER	\$19.82	\$18.58	\$17.35	\$16.11
PSQC-4	CARBON BLOCK FILTER	\$20.77	\$19.47	\$18.18	\$16.88
Part #	Description	1±	3±	15±	30±
PSQC-5	50 GPD RO MEMBRANE	\$90.86	\$85.18	\$79.50	\$73.82



CUNO® Water Factory Filter
(47-55702G2)

Water Factory / CUNO Original Filters

Part #	Description	CASE			
		1±	20±	100±	200±
47-55702G2	SQC SEDIMENT	\$40.86	\$38.00	\$36.18	\$33.31
47-55704G2	SQC GAC	\$56.74	\$52.76	\$50.23	\$46.26
47-55706G2	SQC SED/GAC COMBO	\$39.53	\$37.48	\$35.43	\$32.86

Water Factory / CUNO Original Membranes

Part #	Description	CASE			
		1±	10±	25±	50±
66-4706G-2	SQC 36 GPD TFC	\$274.05	\$243.95	\$229.69	\$218.61

Housings / Filters

H2O INTERNATIONAL® SHOWER FILTERS



H2O International® Shower Filter Heads with chlorine removal system provide you with a simple, effective way to remove this contaminant and improve your shower experience.

H2O International® Shower Filter Heads with chlorine removal system remove up to 99% of harmful chlorine through an advanced medium that utilizes the oxidation and reduction of ions, known as redox. This revolutionary process safely and effectively decreases the amount of chlorine found in shower water, where it has its most hazardous effects - making water safer and gentler for everyday use.



(SH-SN-5)



(SH-WH-5)



(SH-CPG-5)



(SH-CP-1)

Deluxe Shower Filters - 5 Spray

Part #	Description	CASE			
		1±	16±	64±	128±
SH-SN-5	5-SPRAY W/KDF; SATIN NICKEL	\$52.29	\$44.82	\$41.09	\$37.35
SH-WH-5	5-SPRAY W/KDF; WHITE	\$39.97	\$34.26	\$31.40	\$28.55
SH-CPG-5	5-SPRAY W/KDF; CHROME	\$44.96	\$38.54	\$35.33	\$32.12

Part #	Description	CASE			
		1±	32±	64±	128±
SH-FILTER	REPLACEMENT SHOWER FILTER CART.	\$25.32	\$21.71	\$19.90	\$18.09

Hand Held Shower Filters

Part #	Description	CASE			
		1±	36±	72±	144±
SHH-IL-SN	INLINE FILTER FOR HH SHOWER HEAD; SATIN	\$37.47	\$32.12	\$29.44	\$26.77
SHH-IL-CP	INLINE FILTER FOR H.H. SHOWER HEAD; CHROME	\$38.85	\$33.30	\$30.53	\$27.75
IL-FILTER	REPLACEMENT FILTER FOR SSH-IL-CP	\$23.57	\$20.20	\$18.52	\$16.84

Shower Filters - Single Spray

Part #	Description	CASE			
		1±	32±	64±	128±
SH-CP-1	W/KDF; CHROME	\$36.67	\$31.43	\$28.81	\$26.20



(SHH-IL-CP)



(IL-FILTER)



QMP® SHOWER FILTERS



QMP® Shower Filter
(QMP540)

QMP Shower Filters

Part #	Description	CASE			
		1±	10±	50±	100±
QMP540	W/CHROME HEAD	\$66.71	\$62.38	\$59.78	\$55.45
QMP540-W/O HEAD	NO HEAD	\$56.12	\$52.47	\$50.29	\$46.64

SPRITE® SHOWER FILTERS



Handheld Shower w/Hose
(HHE-CM)



Sprite® H/O Shower Filter Head
(HO2-CM-M)



Sprite® Shower Filter
(SR-WH-M)

Sprite Shower Filters

Part #	Description	CASE		
		1±	5±	12±
HHE-CM	HANDHELD SHOWER; W/HOSE; CHROME	\$46.58	\$43.48	\$40.37
HH-WH	HANDHELD SHOWER; W/HOSE; WHITE	\$35.50	\$33.14	\$30.77
HHC-2	HANDHELD FILTER CARTRIDGES; (2PK)	\$16.23	\$15.15	\$14.07
HO2-CM-M	SPRITE H/O SHOWER FILTER & HEAD; CHROME	\$46.66	\$43.55	\$40.44
HOC	H/O REPLACEMENT CARTRIDGE	\$24.34	\$22.72	\$21.10
SLC	SL REPLACEMENT CARTRIDGE	\$16.23	\$15.15	\$14.07

Housings / Filters



FITTINGS, R.O. & FILTER COMPONENTS

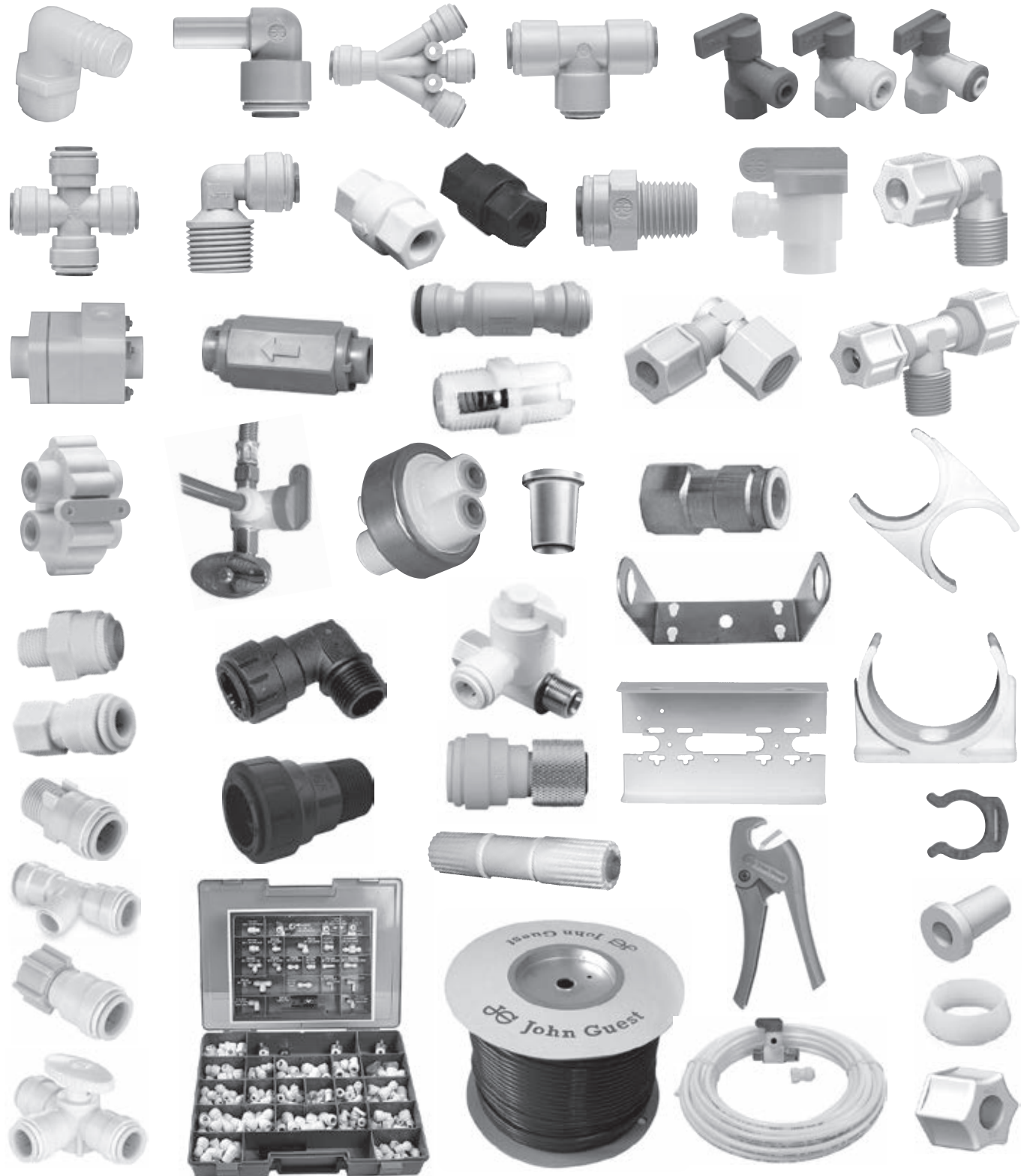

Fittings / Components



JOHN GUEST® FITTINGS

ACETAL Fittings have Nitrile/Buna O-Rings. For higher Chlorine resistance use POLYPROPYLENE Fittings with EPDM O-Rings, Black fittings inhibit UV.

AN RWC BRAND



Installation & Service Kit



Male Connector NPTF

Call for John Guest® parts not listed

Installation & Service Kit

Part #	Description	1±	4±	10±	20±
KIT-ISRK	INSTALLATION & SERVICE KIT	\$274.38	\$228.65	\$205.78	\$192.06
KIT-ISRKE	INSTALLATION & SERVICE KIT BLACK	\$255.80	\$213.17	\$191.85	\$179.06

Male Connector

Part #	Description	1±	100±	500±	1000±
PI010821S	1/4" JG X 1/8" NPT - ACETAL GREY	\$1.27	\$1.06	\$0.95	\$0.85
CI010821W	1/4" JG X 1/8" NPT - ACETAL WHITE	\$1.20	\$1.00	\$0.90	\$0.80
PP010821E	1/4" JG X 1/8" NPT - POLYPRO BLACK	\$1.34	\$1.12	\$1.01	\$0.90
PP010821W	1/4" JG X 1/8" NPT - POLYPRO WHITE	\$1.19	\$1.00	\$0.90	\$0.80
PI010822S	1/4" JG X 1/4" NPT - ACETAL GREY	\$1.47	\$1.22	\$1.10	\$0.98
PP010822E	1/4" JG X 1/4" NPT - POLYPRO BLACK	\$1.30	\$1.09	\$0.98	\$0.87
PP010822W	1/4" JG X 1/4" NPT - POLYPRO WHITE	\$1.30	\$1.09	\$0.98	\$0.87
CI010822W	1/4" JG X 1/4" NPT - ACETAL WHITE	\$1.40	\$1.17	\$1.05	\$0.93
PP010824W	1/4" JG X 1/2" NPT - ACETAL WHITE	\$2.50	\$2.08	\$1.87	\$1.67
PI010823S	1/4" JG X 3/8" NPT - ACETAL GREY	\$1.91	\$1.59	\$1.44	\$1.28
CI010823W	1/4" JG X 3/8" NPT - ACETAL WHITE	\$1.91	\$1.59	\$1.44	\$1.28
PP010823E	1/4" JG X 3/8" NPT - POLYPRO BLACK	\$1.79	\$1.49	\$1.35	\$1.20
PP010823W	1/4" JG X 3/8" NPT - POLYPRO WHITE	\$1.79	\$1.49	\$1.35	\$1.20
PI011221S	3/8" JG X 1/8" NPT - ACETAL GREY	\$2.77	\$2.31	\$2.08	\$1.85
PI011222S	3/8" JG X 1/4" NPT - ACETAL GREY	\$2.08	\$1.73	\$1.56	\$1.39
PP011222W	3/8" JG X 1/4" NPT - POLYPRO WHITE	\$2.06	\$1.72	\$1.55	\$1.37
PP011222E	3/8" JG X 1/4" NPT - POLYPRO BLACK	\$2.25	\$1.88	\$1.69	\$1.50
CI011222W	3/8" JG X 1/4" NPT - ACETAL WHITE	\$2.08	\$1.73	\$1.56	\$1.39
PI011223S	3/8" JG X 3/8" NPT - ACETAL GREY	\$2.40	\$2.00	\$1.80	\$1.60
PP011223W	3/8" JG X 3/8" NPT - POLYPRO WHITE	\$2.25	\$1.88	\$1.69	\$1.50
PI011224S	3/8" JG X 1/2" NPT - ACETAL GREY	\$3.73	\$3.11	\$2.80	\$2.49
PP011224E	3/8" JG X 1/2" NPT - POLYPRO BLACK	\$3.50	\$2.92	\$2.63	\$2.34
PP011224W	3/8" JG X 1/2" NPT - POLYPRO WHITE	\$3.51	\$2.93	\$2.63	\$2.34
PI011623S	1/2" JG X 3/8" NPT - ACETAL GREY	\$3.22	\$2.69	\$2.42	\$2.15
PP011623W	1/2" JG X 3/8" NPT - POLYPRO WHITE	\$3.05	\$2.54	\$2.29	\$2.03
PI011624S	1/2" JG X 1/2" NPT - ACETAL GREY	\$3.47	\$2.89	\$2.60	\$2.32
PP011624W	1/2" JG X 1/2" NPT - POLYPRO WHITE	\$3.27	\$2.73	\$2.46	\$2.18
PI012026S	5/8" JG X 3/4" NPT - ACETAL GREY	\$4.81	\$4.01	\$3.61	\$3.21

Union Tee

Part #	Description	1±	100±	500±	1000±
PI0208S	1/4" JG - ACETAL GREY	\$2.75	\$2.29	\$2.06	\$1.83
CI0208W	1/4" JG - ACETAL WHITE	\$2.75	\$2.29	\$2.06	\$1.83
PP0208E	1/4" JG - POLYPRO BLACK	\$2.52	\$2.10	\$1.89	\$1.81
PP0208W	1/4" JG - POLYPRO WHITE	\$2.52	\$2.10	\$1.89	\$1.68
PI0212S	3/8" JG - ACETAL GREY	\$3.39	\$2.82	\$2.54	\$2.26
CI0212W	3/8" JG - ACETAL WHITE	\$3.39	\$2.82	\$2.54	\$2.26
PP0212E	3/8" JG - POLYPRO BLACK	\$3.08	\$2.56	\$2.31	\$2.05
PP0212W	3/8" JG - POLYPRO WHITE	\$3.08	\$2.56	\$2.31	\$2.05
PI0216S	1/2" JG - ACETAL GREY	\$4.10	\$3.42	\$3.08	\$2.74
PP0216W	1/2" JG - POLYPRO WHITE	\$3.88	\$3.24	\$2.91	\$2.59

Reducing Tee

Part #	Description	1±	100±	500±	1000±
PP30121208W	3/8" JG X 3/8" JG X 1/4" - POLYPRO WHITE	\$3.25	\$2.71	\$2.44	\$2.17
PI301208S	3/8" JG X 3/8" JG X 1/4" - ACETAL GREY	\$4.37	\$3.64	\$3.28	\$2.91
PP30120812W	3/8" JG X 1/4" JG X 3/8" - POLYPRO WHITE	\$3.27	\$2.72	\$2.45	\$2.18
PI301612S	1/2" JG X 1/2" JG X 3/8" - ACETAL GREY	\$4.56	\$3.80	\$3.42	\$3.04
PP301612W	1/2" JG X 1/2" JG X 3/8" - POLYPRO WHITE	\$4.31	\$3.59	\$3.23	\$2.88

Stackable Tee

Part #	Description	1±	100±	150±	300±
PP531212W	3/8" JG X 3/8" JG X 3/8" STEM - POLYPRO WHITE	\$2.72	\$2.27	\$2.04	\$1.95

Fixed Tee Adapter

Part #	Description	1±	100±	150±	300±
PP641223W	3/8" JG X 3/8" JG X 3/8" NPT - POLYPRO WHITE	\$3.22	\$2.69	\$2.42	\$2.15



Union Tee



Reducing Tee



Stackable Tee



Fixed Tee Adapter

Fittings / Components



ACETAL Fittings have Nitrile/Buna O-Rings. For higher Chlorine resistance use POLYPROPYLENE Fittings with EPDM O-Rings, Black fittings inhibit UV.

AN RWC BRAND



Union Elbow

Union Elbow

Part #	Description	1+	100+	500+	1000+
PI0308S	1/4" JG - ACETAL GREY	\$2.15	\$1.79	\$1.61	\$1.43
C10308W	1/4" JG - ACETAL WHITE	\$2.15	\$1.79	\$1.61	\$1.43
PP0308E	1/4" JG - POLYPRO BLACK	\$2.00	\$1.66	\$1.50	\$1.33
PP0308W	1/4" JG - POLYPRO WHITE	\$2.00	\$1.66	\$1.50	\$1.33
PI0312S	3/8" JG - ACETAL GREY	\$3.22	\$2.69	\$2.42	\$2.15
C10312W	3/8" JG - ACETAL WHITE	\$3.32	\$2.77	\$2.49	\$2.22
PP0312E	3/8" JG - POLYPRO BLACK	\$3.05	\$2.54	\$2.29	\$2.03
PP0312W	3/8" JG - POLYPRO WHITE	\$3.05	\$2.54	\$2.29	\$2.03
PI0316S	1/2" JG - ACETAL GREY	\$3.84	\$3.20	\$2.88	\$2.56



Fixed Elbow

Fixed Elbow

Part #	Description	1+	100+	500+	1000+
PI480821S	1/4" JG X 1/8" NPT - ACETAL GREY	\$1.89	\$1.58	\$1.42	\$1.26
C1480821W	1/4" JG X 1/8" NPT - ACETAL WHITE	\$1.89	\$1.58	\$1.42	\$1.26
PP480821E	1/4" JG X 1/8" NPT - POLYPRO BLACK	\$1.77	\$1.48	\$1.33	\$1.18
PP480821W	1/4" JG X 1/8" NPT - POLYPRO WHITE	\$1.77	\$1.48	\$1.33	\$1.18
PI480822S	1/4" JG X 1/4" NPT - ACETAL GREY	\$2.15	\$1.79	\$1.61	\$1.43
C1480822W	1/4" JG X 1/4" NPT - ACETAL WHITE	\$2.15	\$1.80	\$1.62	\$1.44
PP480822E	1/4" JG X 1/4" NPT - POLYPRO BLACK	\$2.24	\$1.87	\$1.68	\$1.49
PP480822W	1/4" JG X 1/4" NPT - POLYPRO WHITE	\$2.04	\$1.70	\$1.53	\$1.36
PI480823S	1/4" JG X 3/8" NPT - ACETAL GREY	\$2.57	\$2.14	\$1.93	\$1.71
C1480823W	1/4" JG X 3/8" NPT - ACETAL WHITE	\$2.57	\$2.14	\$1.93	\$1.71
PP480823E	1/4" JG X 3/8" NPT - POLYPRO BLACK	\$2.42	\$2.01	\$1.81	\$1.61
PP480823W	1/4" JG X 3/8" NPT - POLYPRO WHITE	\$2.42	\$2.01	\$1.81	\$1.61
PI481222S	3/8" JG X 1/4" NPT - ACETAL GREY	\$3.22	\$2.69	\$2.42	\$2.15
C1481222W	3/8" JG X 1/4" NPT - ACETAL WHITE	\$3.22	\$2.69	\$2.42	\$2.15
PP481222E	3/8" JG X 1/4" NPT - POLYPRO BLACK	\$2.68	\$2.23	\$2.01	\$1.79
PP481222W	3/8" JG X 1/4" NPT - POLYPRO WHITE	\$2.68	\$2.23	\$2.01	\$1.79
PI481223S	3/8" JG X 3/8" NPT - ACETAL GREY	\$3.53	\$2.94	\$2.65	\$2.35
PP481223E	3/8" JG X 3/8" NPT - POLYPRO BLACK	\$2.75	\$2.29	\$2.06	\$1.83
PP481223W	3/8" JG X 3/8" NPT - POLYPRO WHITE	\$2.75	\$2.29	\$2.06	\$1.83
PI482024S	5/8" JG X 1/2" NPT - ACETAL GREY	\$4.95	\$4.13	\$3.72	\$3.30

Call for John Guest®
parts not listed



Reducing Elbow

Reducing Elbow

Part #	Description	1+	100+	500+	1000+
PI211208S	3/8" JG X 1/4" JG - ACETAL GREY	\$3.58	\$2.98	\$2.69	\$2.39
PP211208W	3/8" JG X 1/4" JG - POLYPRO WHITE	\$3.36	\$2.80	\$2.52	\$2.24
PI211612S	1/2" JG X 3/8" JG - ACETAL GREY	\$4.22	\$3.52	\$3.17	\$2.82
PP211612W	1/2" JG X 3/8" JG - POLYPRO WHITE	\$4.15	\$3.46	\$3.12	\$2.77

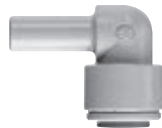

Plug In /Stem Elbow

Plug In / Stem Elbow

Part #	Description	1+	100+	500+	1000+
PI220808S	1/4" X 1/4" JG - ACETAL GREY	\$1.93	\$1.61	\$1.45	\$1.29
C1220808W	1/4" X 1/4" JG - ACETAL WHITE	\$1.93	\$1.61	\$1.45	\$1.29
PP220808E	1/4" X 1/4" JG - POLYPRO BLACK	\$1.80	\$1.50	\$1.35	\$1.20
PP220808W	1/4" X 1/4" JG - POLYPRO WHITE	\$1.80	\$1.50	\$1.35	\$1.20
PI221208S	3/8" X 1/4" JG - ACETAL GREY	\$2.59	\$2.16	\$1.95	\$1.73
C1221208W	3/8" X 1/4" JG - ACETAL WHITE	\$2.59	\$2.16	\$1.95	\$1.73
PP221208W	3/8" X 1/4" JG - POLYPRO WHITE	\$2.46	\$2.05	\$1.85	\$1.64
PI221212S	3/8" X 3/8" JG - ACETAL GREY	\$3.29	\$2.75	\$2.47	\$2.20
C1221212W	3/8" X 3/8" JG - ACETAL WHITE	\$3.29	\$2.75	\$2.47	\$2.20
PP221212E	3/8" X 3/8" JG - POLYPRO BLACK	\$3.05	\$2.54	\$2.29	\$2.03
PP221212W	3/8" X 3/8" JG - POLYPRO WHITE	\$3.05	\$2.54	\$2.29	\$2.03
PI221616S	1/2" X 1/2" JG - ACETAL GREY	\$3.94	\$3.29	\$2.96	\$2.63
PP221616W	1/2" X 1/2" JG - POLYPRO WHITE	\$3.73	\$3.11	\$2.80	\$2.67



Union Connector

Union Connector

Part #	Description	1+	100+	500+	1000+
PI0408S	1/4" JG - ACETAL GREY	\$1.89	\$1.58	\$1.42	\$1.26
C10408W	1/4" JG - ACETAL WHITE	\$1.89	\$1.58	\$1.42	\$1.26
PP0408E	1/4" JG - POLYPRO BLACK	\$1.76	\$1.47	\$1.32	\$1.18
PP0408W	1/4" JG - POLYPRO WHITE	\$1.76	\$1.47	\$1.32	\$1.18
PI0412S	3/8" JG - ACETAL GREY	\$2.56	\$2.14	\$1.92	\$1.71
C10412W	3/8" JG - ACETAL WHITE	\$2.56	\$2.14	\$1.92	\$1.71
PP0412E	3/8" JG - POLYPRO BLACK	\$2.37	\$1.98	\$1.78	\$1.58
PP0412W	3/8" JG - POLYPRO WHITE	\$2.37	\$1.98	\$1.78	\$1.58
PI0416S	1/2" JG - ACETAL GREY	\$2.96	\$2.46	\$2.22	\$1.97
PP0416W	1/2" JG - POLYPRO WHITE	\$2.80	\$2.33	\$2.10	\$1.87

Fittings / Components



ACETAL Fittings have Nitrile/Buna O-Rings. For higher Chlorine resistance use POLYPROPYLENE Fittings with EPDM O-Rings, Black fittings inhibit UV.

AN RWC BRAND

RWC



Reducing Union

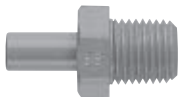

Stem Adapter

Call for John Guest®
parts not listed



Stem Reducer



Bulkhead Union



Faucet Connector UNS Thread



Female Connector NPTF Thread

Reducing Union

Part #	Description	1+	100+	500+	1000+
PI201008S	1/4" JG X 5/16" JG - ACETAL GREY	\$2.08	\$1.73	\$1.56	\$1.39
PI201208S	3/8" JG X 1/4" JG - ACETAL GREY	\$2.57	\$2.15	\$1.93	\$1.72
PP201208E	3/8" JG X 1/4" JG - POLYPRO BLACK	\$2.43	\$2.02	\$1.82	\$1.62
PP201208W	3/8" JG X 1/4" JG - POLYPRO WHITE	\$2.43	\$2.02	\$1.82	\$1.62
PI201210S	3/8" JG X 5/16" JG - ACETAL GREY	\$2.61	\$2.17	\$1.96	\$1.74
PI201612S	1/2" JG X 3/8" JG - ACETAL GREY	\$3.47	\$2.89	\$2.60	\$2.32
PP201612E	1/2" JG X 3/8" JG - POLYPRO BLACK	\$3.27	\$2.73	\$2.46	\$2.18
PP201612W	1/2" JG X 3/8" JG - POLYPRO WHITE	\$3.27	\$2.73	\$2.46	\$2.35

Stem Adapter

Part #	Description	1+	100+	500+	1000+
PI050821S	1/4" X 1/8" NPT - ACETAL GREY	\$0.65	\$0.55	\$0.49	\$0.44
CI050821W	1/4" X 1/8" NPT - ACETAL WHITE	\$0.65	\$0.55	\$0.49	\$0.44
PP050821E	1/4" X 1/8" NPT - POLYPRO BLACK	\$0.77	\$0.65	\$0.58	\$0.52
PP050821W	1/4" X 1/8" NPT - POLYPRO WHITE	\$0.63	\$0.52	\$0.47	\$0.42
PI050822S	1/4" X 1/4" NPT - ACETAL GREY	\$0.65	\$0.55	\$0.49	\$0.44
CI050822W	1/4" X 1/4" NPT - ACETAL WHITE	\$0.65	\$0.55	\$0.49	\$0.44
PP050822E	1/4" X 1/4" NPT - POLYPRO BLACK	\$0.70	\$0.58	\$0.52	\$0.47
PP050822W	1/4" X 1/4" NPT - POLYPRO WHITE	\$0.63	\$0.52	\$0.47	\$0.42
PI051222S	3/8" X 1/4" NPT - ACETAL GREY	\$0.82	\$0.68	\$0.62	\$0.55
CI051222W	3/8" X 1/4" NPT - ACETAL WHITE	\$0.82	\$0.68	\$0.62	\$0.55
PP051222W	3/8" X 1/4" NPT - POLYPRO WHITE	\$0.76	\$0.64	\$0.57	\$0.51
PI051223S	3/8" X 3/8" NPT - ACETAL GREY	\$1.08	\$0.90	\$0.81	\$0.72
CI051223W	3/8" X 3/8" NPT - ACETAL WHITE	\$1.02	\$0.85	\$0.76	\$0.68
PP051223E	3/8" X 3/8" NPT - POLYPRO BLACK	\$1.02	\$0.85	\$0.76	\$0.68
PP051223W	3/8" X 3/8" NPT - POLYPRO WHITE	\$0.97	\$0.81	\$0.73	\$0.65
PI051623S	1/2" X 3/8" NPT - ACETAL GREY	\$1.76	\$1.47	\$1.32	\$1.18
PP051623W	1/2" X 3/8" NPT - POLYPRO WHITE	\$1.58	\$1.32	\$1.19	\$1.06
PI051624S	1/2" X 1/2" NPT - ACETAL GREY	\$1.76	\$1.47	\$1.32	\$1.18
PP051624W	1/2" X 1/2" NPT - POLYPRO WHITE	\$1.58	\$1.32	\$1.19	\$1.06

Stem Reducer

Part #	Description	1+	100+	500+	1000+
PI061208S	3/8" X 1/4" JG - ACETAL GREY	\$2.08	\$1.73	\$1.56	\$1.39
CI061208W	3/8" X 1/4" JG - ACETAL WHITE	\$2.80	\$2.33	\$2.10	\$1.87
PP061208W	3/8" X 1/4" JG - POLYPRO WHITE	\$1.94	\$1.62	\$1.46	\$1.30
PI061612S	1/2" X 3/8" JG - ACETAL GREY	\$3.95	\$3.29	\$2.96	\$2.63
PP061612W	1/2" X 3/8" JG - POLYPRO WHITE	\$3.73	\$3.11	\$2.80	\$2.49

Bulkhead Union

Part #	Description	1+	100+	500+	1000+
PI1208S	1/4" JG - 0.67 - ACETAL GREY	\$3.61	\$3.01	\$2.71	\$2.41
CI1208W	1/4" JG - 0.67 ACETAL WHITE	\$3.29	\$2.75	\$2.47	\$2.20
PP1208E	1/4" JG - 0.67 - POLYPRO BLACK	\$3.40	\$2.84	\$2.55	\$2.27
PP1208W	1/4" JG - 0.67 - POLYPRO WHITE	\$3.40	\$2.84	\$2.55	\$2.27
PI1212S	3/8" JG - 0.83 - ACETAL GREY	\$4.70	\$3.92	\$3.53	\$3.13
PP1212E	3/8" JG - 0.83 - POLYPRO BLACK	\$4.43	\$3.69	\$3.32	\$2.96
PP1212W	3/8" JG - 0.83 - POLYPRO WHITE	\$4.43	\$3.69	\$3.32	\$2.96
PI1216S	1/2" JG - 1.06 - ACETAL GREY	\$8.02	\$6.69	\$6.02	\$5.35
PP1216W	1/2" JG - 1.06 - POLYPRO WHITE	\$6.85	\$5.71	\$5.14	\$4.57

Reducing Bulkhead Union

Part #	Description	1+	100+	500+	1000+
PI121208S	3/8" JG X 1/4" JG - 0.83 - ACETAL GREY	\$4.70	\$3.92	\$3.53	\$3.13
PP121208W	3/8" JG X 1/4" JG - 0.83 - POLYPRO WHITE	\$4.25	\$3.54	\$3.19	\$2.83

Faucet Connector UNS Thread

Part #	Description	1+	100+	500+	1000+
CI3208U7S	1/4" JG X 7/16" NPT 24 UNS-ACETAL GREY	\$2.42	\$2.01	\$1.81	\$1.61
PP3208U7W	1/4" JG X 7/16" NPT 24 UNS POLYPRO WHITE	\$2.59	\$2.16	\$1.94	\$1.73
CI3212U7S	3/8" JG X 7/16" NPT 24 UNS-ACETAL GREY	\$2.69	\$2.24	\$2.02	\$1.79
PP3212U7W	3/8" JG X 7/16" NPT 24 UNS-POLYPRO WHITE	\$2.66	\$2.22	\$2.00	\$1.78

Female Connector NPTF Thread

Part #	Description	1+	100+	500+	1000+
PI450822S	1/4" JG X 1/4" NPT - ACETAL GREY	\$2.96	\$2.47	\$2.22	\$1.98
PP450822E	1/4" JG X 1/4" NPT - POLYPRO BLACK	\$4.02	\$3.35	\$3.02	\$2.68
PP450822W	1/4" JG X 1/4" NPT - POLYPRO WHITE	\$4.02	\$3.35	\$3.02	\$2.68
PI451222S	3/8" JG X 1/4" NPT - ACETAL GREY	\$3.40	\$2.84	\$2.55	\$2.27
PP451223W	3/8" JG X 3/8" NPT - POLYPRO WHITE	\$5.45	\$4.54	\$4.09	\$3.63



Female Flare Connector FFL Thread

Female Flare Connector FFL Thread

Part #	Description	1+	100+	500+	1000+
PI4512F4S	3/8" JG X 1/4" NPT - ACETAL GREY	\$2.66	\$2.22	\$1.99	\$1.91
PI4512F6S	3/8" JG X 3/8" NPT - ACETAL GREY	\$3.24	\$2.70	\$2.43	\$2.16



Female Compression Fitting

Female Compression Fittings

Part #	Description	1+	100+	500+	1000+
PP6008U9W	1/4" JG x 3/8" Comp [9/16-24un]	\$4.07	\$3.39	\$3.05	\$2.71
PSEI6012U9	3/8" JG x 3/8" Comp [9/16-24un]	\$6.91	\$5.99	\$5.53	\$5.07



Stem to Hose Barb

Stem to Hose Barb

Part #	Description	1+	100+	500+	1000+
PI250808S	1/4" X 1/4" - ACETAL GREY	\$1.20	\$1.00	\$0.90	\$0.80
PI251208S	3/8" X 1/4" - ACETAL GREY	\$1.76	\$1.47	\$1.32	\$1.18
PI251212S	3/8" X 3/8" - ACETAL GREY	\$1.89	\$1.58	\$1.42	\$1.26
PP251212W	3/8" X 3/8" - POLYPRO WHITE	\$1.78	\$1.48	\$1.34	\$1.19
PI251216S	3/8" X 1/2" - ACETAL GREY	\$2.56	\$2.14	\$1.92	\$1.71
PP251216W	3/8" X 1/2" - POLYPRO WHITE	\$2.41	\$2.01	\$1.81	\$1.61
PI251612S	1/2" X 3/8" - ACETAL GREY	\$2.05	\$1.71	\$1.54	\$1.37
PP251612W	1/2" X 3/8" - POLYPRO WHITE	\$1.92	\$1.60	\$1.44	\$1.28
PI251616S	1/2" X 1/2" - ACETAL GREY	\$2.65	\$2.21	\$1.99	\$1.77
PP251616W	1/2" X 1/2" - POLYPRO WHITE	\$2.38	\$1.98	\$1.78	\$1.71



Stem to Hose Barb Elbow

Stem to Hose Barb Elbow

Part #	Description	1+	100+	500+	1000+
PI290808S	1/4" X 1/4" - ACETAL GREY	\$1.62	\$1.35	\$1.22	\$1.08
PI291208S	3/8" X 1/4" - ACETAL GREY	\$2.05	\$1.71	\$1.54	\$1.37



Plug

Plug

Part #	Description	1+	100+	500+	1000+
PI0808S	1/4" - ACETAL GREY	\$0.54	\$0.45	\$0.41	\$0.36
PP0808W	1/4" - POLYPRO WHITE	\$0.49	\$0.41	\$0.37	\$0.33
PI0812S	3/8" - ACETAL GREY	\$0.88	\$0.73	\$0.66	\$0.59
PP0812W	3/8" - POLYPRO WHITE	\$0.82	\$0.68	\$0.62	\$0.59
PI0816S	1/2" - ACETAL GREY	\$1.31	\$1.09	\$0.98	\$0.87
PP0816W	1/2" - POLYPRO WHITE	\$1.27	\$1.06	\$0.95	\$0.85



End Stop

End Stop

Part #	Description	1+	100+	500+	1000+
PI4608S	1/4" JG - ACETAL GREY	\$1.27	\$1.06	\$0.95	\$0.85
PI4612S	3/8" JG - ACETAL GREY	\$1.58	\$1.31	\$1.18	\$1.05



Cross

Cross

Part #	Description	1+	100+	500+	1000+
PI4712S	3/8" JG - ACETAL GREY	\$5.97	\$4.98	\$4.48	\$3.98



Two Way Divider

Two-Way Divider

Part #	Description	1+	100+	500+	1000+
PI2308S	1/4" JG - ACETAL GREY	\$3.06	\$2.55	\$2.30	\$2.04
PP2308E	1/4" JG - POLYPRO BLACK	\$3.64	\$3.04	\$2.73	\$2.43
PI2312S	3/8" JG - ACETAL GREY	\$3.45	\$2.87	\$2.59	\$2.30
PP2312W	3/8" JG - POLYPRO WHITE	\$3.32	\$2.77	\$2.49	\$2.38
PI2316S	1/2" JG - ACETAL GREY	\$5.86	\$4.88	\$4.39	\$3.91



Three Way Divider

Three-Way Divider

Part #	Description	1+	100+	500+	1000+
PI491612S	1/2" JG X 3/8" JG (X3) - ACETAL GREY	\$7.84	\$6.53	\$5.88	\$5.23



U-Bend

U-Bend

Part #	Description	1+	100+	500+	1000+
PIUB16S	1/2" JG - ACETAL GREY	\$8.35	\$6.96	\$6.26	\$5.57



Locking Clip

Locking Clip

Part #	Description	1+	100+	500+	1000+
PIC1808R	1/4"	\$0.18	\$0.15	\$0.14	\$0.12
PIC1812R	3/8"	\$0.21	\$0.17	\$0.16	\$0.14
PIC1816R	1/2"	\$0.21	\$0.17	\$0.16	\$0.14



O-Ring

O-Rings

Part #	Description	1+	100+	500+	1000+
CA-R08I-S	JG 1/4" EPDM	\$0.13	\$0.11	\$0.10	\$0.09
CA-R12I-S	JG 3/8" EPDM	\$0.20	\$0.17	\$0.15	\$0.14
CP-R08I-S	JG 1/4" NITRILE/BUNA	\$0.13	\$0.11	\$0.10	\$0.09
CP-R12I-S	JG 3/8" NITRILE/BUNA	\$0.15	\$0.13	\$0.11	\$0.10
CP-R16I-S	JG 1/2" NITRILE/BUNA	\$0.18	\$0.15	\$0.14	\$0.12



JOHN GUEST® BALL VALVES

John Guest® ASPP valves are offered in white polypropylene with food grade EPDM 'o'-rings. The valve connects between your valve and riser, to the main water supply line, for applications in Reverse Osmosis, Filtration systems, Automatic Coffee Brewers, Ice-makers, and many more. The conversion adaptor can be threaded to either side of the valve to make configurations of 1/2" x 1/2" NPS or 3/8" x 3/8" Compression. The valves are not to be used with compressed air, explosive gases, petroleum spirits and other fuels, or for heating systems.

AN RWC BRAND



Tank Ball Valve



Inline Ball Valves



Metal Angle Stop Adapter Valve (ASVPP5LF)



Plastic Angle Stop Adapter Valve (PASVPP5)

Tank Ball Valves

Part #	Description	1+	50+	100+	500+
PPSV500822W	1/4" JG X 1/4" FEMALE NPTF ELBOW	\$6.29	\$5.45	\$4.93	\$4.61
PPSV501222W	3/8" JG X 1/4" FEMALE NPTF ELBOW	\$6.56	\$5.69	\$5.14	\$4.81

Inline Ball Valves

Part #	Description	1+	50+	100+	500+
PPSV040808W	1/4" JG X 1/4" JG STRAIGHT VALVE	\$5.70	\$4.94	\$4.47	\$4.18
PPSV040808E	1/4" JG X 1/4" JG STRAIGHT VALVE - PP - BLACK	\$5.70	\$4.94	\$4.47	\$4.18
PPSV041212W	3/8" JG X 3/8" JG STRAIGHT VALVE	\$6.03	\$5.22	\$4.72	\$4.42
PPSV041212E	3/8" JG X 3/8" JG STRAIGHT VALVE - PP - BLACK	\$6.03	\$5.22	\$4.72	\$4.42
PPSV010822W	1/4" MIP X 1/4" JG STRAIGHT VALVE	\$5.70	\$4.94	\$4.47	\$4.18
PPSV011223W	3/8" MIP X 3/8" JG STRAIGHT VALVE	\$6.03	\$5.22	\$4.72	\$4.42
PISV0416S	1/2" JG X 1/2" JG STRAIGHT VALVE	\$8.32	\$6.94	\$6.24	\$5.55

Metal Angle Stop Adapter Valves

Part #	Description	1+	30+	150+	300+
ASVPP1LF	JG 3/8" MALE X 3/8" FEMALE X 1/4" JG; LEAD FREE	\$12.11	\$10.50	\$9.49	\$8.89
ASVPP2LF	JG 3/8" MALE X 3/8" FEMALE X 3/8" JG; LEAD FREE	\$12.57	\$10.89	\$9.84	\$8.80
ASVPP5LF	JG 1/2" x 3/8" x 1/4" JG ANGLE STOP ADAPTER	\$19.66	\$17.04	\$15.40	\$13.76

Part #	Description	1+	20+	100+	200+
ASVPP6LF	JG 1/2" x 3/8" x 3/8" JG ANGLE STOP ADAPTER	\$20.76	\$17.99	\$16.26	\$14.53

Plastic Angle Stop Adapter Valves

Part #	Description	1+	25+	125+	250+
PASVPP1	3/8x3/8x1/4 ASV; PLASTIC	\$9.23	\$8.00	\$7.23	\$6.93
PASVPP2	3/8x3/8x3/8 ASV; PLASTIC	\$9.57	\$8.30	\$7.50	\$7.18
PASVPP5	3/8x3/8x1/4 ASV 1/2 ADPTR; PLASTIC	\$14.97	\$12.97	\$11.73	\$11.23
PASVPP6	3/8x3/8x3/8 ASV; 1/2 ADPTR; PLASTIC	\$15.81	\$13.70	\$12.39	\$11.86

Fittings / Components

JOHN GUEST® CHECK VALVES

AN RWC BRAND



Inline Check Valve

John Guest® Inline Check Valves are designed with Super Speedfit technology, featuring the same simplicity as JG fittings providing a fast & secure way of connecting plastic tubing without the use of tools. The valves can be mounted in any position; the arrow indicates the direction of flow.

Check Valves - Inline

Part #	Description	1+	100+	200+	500+
1/4SCV	1/4" JG	\$10.59	\$8.83	\$7.95	\$7.06
Part #	Description	1+	100+	500+	1000+
5/16SCV	5/16" JG	\$10.60	\$8.83	\$7.95	\$7.07
Part #	Description	1+	80+	400+	800+
3/8SCV	3/8" JG	\$10.84	\$9.04	\$8.13	\$7.23
Part #	Description	1+	100+	200+	500+
1/2SCV	1/2" JG	\$11.43	\$9.52	\$8.57	\$7.62



JOHN GUEST® BRASS FITTINGS

AN RWC BRAND



Brass Fitting



Garden Hose Connector (NC2258)

Lead Free Brass Fittings

Part #	Description	1+	100+	500+	1000+
MI4512F4SLF	3/8 X 1/4 FFL F ADAPTER	\$6.43	\$5.36	\$4.82	\$4.29
MI4512F6SLF	3/8 X 3/8 FFL F ADAPTER	\$9.40	\$7.83	\$7.05	\$6.27
NC2098LF	1/4 X 3/4 GARDEN HOSE	\$12.40	\$10.33	\$9.30	\$8.27

Part #	Description	1+	10+	50+	100+
WSK-B	WATER SUPPLY KIT 25FT. [BLUE]	\$22.04	\$18.37	\$16.53	\$14.70
WSK-W	WATER SUPPLY KIT 25FT. [WHITE]	\$22.04	\$18.37	\$16.53	\$14.70

Brass Female Garden Hose Connector

Part #	Description	1+	100+	500+	1000+
NC2098LF	1/4" X 3/4" GARDEN HOSE; LEADFREE BRASS	\$12.40	\$10.33	\$9.30	\$8.27
NC2258	3/8" X 3/4" BRASS/PP FEMALE	\$10.34	\$8.62	\$7.76	\$6.89

JOHN GUEST® TUBE CUTTER & BLADES

AN RWC BRAND



Tube Cutter

Tube Cutter and Blades

Part #	Description	1+	100+	500+	1000+
TSNIP	TUBE CUTTER	\$12.62	\$10.52	\$9.47	\$8.42
BLADES	TUBE CUTTER REPLACE BLADES	\$3.73	\$3.11	\$2.80	\$2.49

JOHN GUEST® PE TUBING

AN RWC BRAND



John Guest® Tubing is designed for use with JG Push-in fittings, John Guest® Shut-Off Valves and virtually all standard tubing connectors.



Water Supply Kit (white) (WSK-W)



Linear Low Density Polyethylene Tubing

Water Supply / Ice Maker Kit

Part #	Description	1+	10+	50+	100+
ICE MAKER KIT	WATER SUPPLY KIT 25FT. [CLEAR]	\$22.04	\$18.37	\$16.53	\$14.70
WSK-B	WATER SUPPLY KIT 25FT. [BLUE]	\$22.04	\$18.37	\$16.53	\$14.70
WSK-W	WATER SUPPLY KIT 25FT. [WHITE]	\$22.04	\$18.37	\$16.53	\$14.70

1/4" O.D. PE Tubing - 500 Feet*

* (Two 500 Foot Rolls Per Box, Minimum Order One Box of same color)

Part #	Description	1+	4+	10+	20+
PE08-BI-0500F-B	BLUE	\$62.46	\$51.83	\$46.51	\$43.86
PE08-BI-0500F-E	BLACK	\$62.46	\$51.83	\$46.51	\$43.86
PE08-BI-0500F-G	GREEN	\$62.46	\$51.83	\$46.51	\$43.86
PE08-BI-0500F-N	NATURAL	\$62.45	\$51.82	\$46.51	\$43.85
PE08-BI-0500F-O	ORANGE	\$62.45	\$51.82	\$46.51	\$43.85
PE08-BI-0500F-R	RED	\$62.46	\$51.83	\$46.51	\$43.86
PE08-BI-0500F-W	WHITE	\$62.45	\$51.82	\$46.51	\$43.85
PE08-BI-0500F-Y	YELLOW	\$62.45	\$51.82	\$46.51	\$43.85

3/8" O.D. PE Tubing - 500 Feet

Part #	Description	1+	4+	10+	20+
PE12-EI-0500F-B	BLUE	\$140.50	\$116.59	\$104.63	\$98.65
PE12-EI-0500F-E	BLACK	\$140.50	\$116.59	\$104.63	\$98.65
PE12-EI-0500F-G	GREEN	\$140.50	\$116.59	\$104.63	\$98.65
PE12-EI-0500F-N	NATURAL	\$140.50	\$116.59	\$104.63	\$98.65
PE12-EI-0500F-O	ORANGE	\$140.50	\$116.59	\$104.63	\$98.65
PE12-EI-0500F-R	RED	\$146.48	\$110.61	\$104.63	\$98.65
PE12-EI-0500F-W	WHITE	\$140.50	\$116.59	\$104.63	\$98.65
PE12-EI-0500F-Y	YELLOW	\$140.50	\$116.59	\$104.63	\$98.65

1/2" O.D. PE Tubing - 250 Feet

Part #	Description	1+	4+	10+	20+
PE16-GI-0250F-B	BLUE	\$100.88	\$83.71	\$75.12	\$70.83
PE16-GI-0250F-E	BLACK	\$100.88	\$83.71	\$75.12	\$70.83
PE16-GI-0250F-N	NATURAL	\$105.17	\$79.41	\$75.12	\$70.83
PE16-GI-0250F-R	RED	\$100.88	\$83.71	\$75.12	\$70.83
PE16-GI-0250F-W	WHITE	\$100.88	\$83.71	\$75.12	\$70.83

John Guest® Fittings on page (104)

John Guest® Large Diameter Fittings on next page



JOHN GUEST® [ProLock] SOFTENER / LARGE DIAMETER FITTINGS

AN RWC BRAND
RWC



POLYPROPYLENE TUBING SIZE
OUTSIDE DIAMETER [OD]

- 3/8" O.D
- 1/2" O.D
- 5/8" O.D
- 7/8" O.D
- 1 1/8" O.D

COPPER TUBE SIZE
INSIDE DIAMETER [ID]

- 1/4" CTS NOT AVAILABLE
- 3/8" CTS
- 1/2" CTS
- 3/4" CTS
- 1" CTS

Male Connector

Part #	Description	1±	80±	400±	800±
PSEI012024E	1/2" CTS X 1/2" NPT - BLACK	\$5.91	\$5.12	\$4.73	\$4.34
PSEI012026E	1/2" CTS X 3/4" NPT - BLACK	\$6.70	\$5.81	\$5.36	\$4.91
PSEI012826E	3/4" CTS X 3/4" NPT - BLACK	\$7.54	\$6.54	\$6.03	\$5.53
PSEI012828E	3/4" CTS X 1" NPT - BLACK	\$9.16	\$7.94	\$7.33	\$6.72
PSEI013626E	1" CTS X 3/4" NPT - BLACK	\$13.78	\$11.95	\$11.03	\$10.11
PSEI013628E	1" CTS X 1" NPT - BLACK	\$15.23	\$13.20	\$12.18	\$11.17



(PSEI013628E)

Female Connector

Part #	Description	1±	150±	750±	1500±
PSEI622836E	3/4" CTS X 3/4" NPS - BLACK	\$15.32	\$13.28	\$12.25	\$11.23
PSEI622838E	3/4" CTS X 1" NPS - BLACK	\$15.85	\$13.74	\$12.68	\$11.62
PSEI623638E	1" CTS X 1" NPS - BLACK	\$18.12	\$15.71	\$14.50	\$13.29
PSEI62363AE	1" CTS X 1.25" FPT - BLACK	\$18.65	\$16.16	\$14.92	\$13.68



(PSEI622836E)



(PSEI482024E)

Male Elbow

Part #	Description	1±	60±	300±	600±
PSEI482024E	1/2" CTS X 1/2" NPT - BLACK	\$8.82	\$7.65	\$7.06	\$6.47

Female Elbow

Part #	Description	1±	150±	750±	1500±
PSEI632836E	3/4" CTS X 3/4" NPS - BLACK	\$15.46	\$13.40	\$12.37	\$11.34
PSEI632838E	3/4" CTS X 1" NPS - BLACK	\$18.41	\$15.96	\$14.73	\$13.50
PSEI63283AE	3/4" CTS X 1.25" FPT - BLACK	\$20.74	\$17.97	\$16.59	\$15.21
PSEI63363AE	1" CTS X 1.25" FPT - BLACK	\$23.73	\$20.56	\$18.98	\$17.40



(PSEI632836E)



(PSEI052826E)

Male Stem Adapter

Part #	Description	1±	50±	250±	500±
PSEI052826E	3/4" CTS X 3/4" NPT - BLACK	\$5.79	\$5.02	\$4.64	\$4.25
PSEI053628E	1" CTS X 1" NPT - BLACK	\$10.38	\$9.00	\$8.30	\$7.61

Fittings / Components



(PEI0328E)

Union Elbow

Part #	Description	1+	40+	200+	400+
PEI0320	1/2" CTS	\$5.70	\$4.94	\$4.56	\$4.18
Part #	Description	1+	20+	100+	200+
PEI0328E	3/4" CTS - BLACK	\$8.57	\$7.43	\$6.85	\$6.28
Part #	Description	1+	10+	50+	100+
PEI0336E	1" CTS - BLACK	\$14.37	\$12.46	\$11.50	\$10.54



(PEI222828E)

Plug in Stem Elbow

Part #	Description	1+	60+	300+	600+
PEI222020	1/2" CTS	\$4.00	\$3.46	\$3.20	\$2.93
Part #	Description	1+	25+	50+	100+
PEI222828E	3/4" CTS X 3/4" S PLUG IN ELB; BLACK	\$6.71	\$5.82	\$5.37	\$4.93
Part #	Description	1+	5+	50+	100+
PEI223636E	1" CTS X 1" S PLUG IN ELB; BLACK	\$12.32	\$10.68	\$9.86	\$9.04



(PEI062820)

Reducer

Part #	Description	1+	50+	250+	500+
PEI062820	3/4" STEM x 1/2" CTS	\$5.61	\$4.86	\$4.49	\$4.12
Part #	Description	1+	30+	150+	300+
PEI063628	1" STEM x 3/4" CTS REDUCER	\$7.43	\$6.44	\$5.95	\$5.45



(PEI0228E)

Union Tee

Part #	Description	1+	25+	125+	250+
PEI0220	1/2" CTS	\$5.84	\$5.06	\$4.67	\$4.28
Part #	Description	1+	10+	50+	100+
PEI0228E	3/4" CTS - BLACK	\$9.73	\$8.43	\$7.78	\$7.14
Part #	Description	1+	5+	25+	50+
PEI0236E	1" CTS - BLACK	\$17.22	\$14.93	\$13.78	\$12.63

Reducing Tee

Part #	Description	1+	15+	75+	150+
PEI3028A	3/4" X 3/4" CTS X 1/2" CTS	\$9.25	\$8.02	\$7.40	\$6.79
PEI3028D	3/4" X 1/2" CTS X 3/4" CTS	\$9.25	\$8.02	\$7.40	\$6.79
Part #	Description	1+	20+	100+	200+
PEI3028C	1/2" X 1/2" CTS X 3/4" CTS	\$8.54	\$7.40	\$6.83	\$6.26



(PEI532020)

Stackable Tee

Part #	Description	1+	30+	150+	300+
PEI532020	1/2x1/2x1/2" CTS	\$7.30	\$6.32	\$5.84	\$5.35

Coupler

Part #	Description	1+	40+	200+	400+
PEI0420	1/2" CTS	\$4.97	\$4.30	\$3.97	\$3.64
Part #	Description	1+	25+	125+	250+
PEI0428E	3/4" CTS - BLACK	\$6.55	\$5.68	\$5.24	\$4.80
Part #	Description	1+	15+	75+	150+
PEI0436E	1" CTS - BLACK	\$12.68	\$10.99	\$10.14	\$9.30



(PEI0428E)

Reducing Coupler

Part #	Description	1+	80+	400+	800+
PSEI202016	1/2" CTS X 3/8" CTS	\$8.70	\$7.54	\$6.96	\$6.38
Part #	Description	1+	40+	120+	200+
PSEI202008	1/2" CTS X 1/4" OD	\$7.80	\$6.76	\$6.24	\$5.72
PSEI202820E	3/4" CTS X 1/2" CTS - BLACK	\$8.51	\$7.38	\$6.81	\$6.24
Part #	Description	1+	40+	120+	240+
PSEI202012	1/2" CTS X 3/8" OD	\$7.97	\$6.91	\$6.38	\$5.85
Part #	Description	1+	15+	75+	150+
PEI203628E	1" X 3/4" CTS - BLACK	\$11.15	\$9.66	\$8.92	\$8.18



(PEI203628E)



POLYPROPYLENE TUBING SIZE OUTSIDE DIAMETER [OD]

- 3/8" O.D
- 1/2" O.D
- 5/8" O.D
- 7/8" O.D
- 1 1/8" O.D

COPPER TUBE SIZE INSIDE DIAMETER [ID]

- 1/4" CTS NOT AVAILABLE
- 3/8" CTS
- 1/2" CTS
- 3/4" CTS
- 1" CTS



End Cap

Part #	Description	1+	5+	80+	160+
PSEI4628	3/4" CTS END CAP	\$5.14	\$4.46	\$4.11	\$3.77
PSEI4636	1" CTS END CAP	\$8.24	\$7.14	\$6.59	\$6.04



Female Swivel Connector

Part #	Description	1+	50+	250+	500+
PEISTC2034	1/2" CTS X 1/2" NPS	\$6.78	\$5.88	\$5.42	\$4.97



Female Swivel Elbow

Part #	Description	1+	50+	250+	500+
PEIBTC2034	1/2" CTS X 1/2" NPS	\$6.78	\$5.88	\$5.42	\$4.97



Shut Off Valve

Part #	Description	1+	75+	375+	750+
PSEISV28EP	3/4" CTS	\$22.99	\$19.92	\$18.39	\$16.86



Superseal Pipe Insert

Part #	Description	1+	100+	500+	1000+
STS120	1/2" CTS	\$0.43	\$0.36	\$0.32	\$0.29
STS128	3/4" CTS	\$0.81	\$0.68	\$0.61	\$0.54



Pipe Insert

Part #	Description	1+	100+	500+	1000+
TS120	1/2" CTS	\$0.42	\$0.35	\$0.32	\$0.28
TS128	3/4" CTS	\$0.61	\$0.51	\$0.46	\$0.41



Nail Clip

Part #	Description	1+	100+	500+	1000+
NPC120	1/2" CTS	\$0.14	\$0.12	\$0.11	\$0.10
NPC128	3/4" CTS	\$0.17	\$0.14	\$0.13	\$0.12



Pipe Clip

Part #	Description	1+	200+	2000+	4000+
USCLIP20	1/2" CTS PIPE CLIP	\$0.28	\$0.26	\$0.25	\$0.23
USCLIP28	3/4" CTS PIPE CLIP	\$0.34	\$0.40	\$0.37	\$0.34



Pipe Cutters

Part #	Description	1+	5+	10+
JG-TS	JG PIPE CUTTER	\$41.22	\$38.05	\$34.88
JG HDC	JG HEAVY DUTY PIPE CUTTER	\$77.27	\$64.39	\$57.96
				25+
				\$51.52



Fittings / Components



AquaLock™ 10 SERIES FITTINGS



AquaLock™ is proud to introduce the new 10 Series polypropylene fittings for POU installations and drinking water systems, beverage service, and water filtration applications. ANSI/NSF-61 Approved

FOR USE WITH:

PEX, POLYETHYLENE, NYLON, POLYPROPYLENE, POLYURETHANE, COPPER, BRASS AND MILD STEEL TUBING.

Male Connectors



(1001-0402)

Part #	Description	1+	100+	500+
1001-0402	ST 1/4"QC X 1/8"MPT	\$0.94	\$0.85	\$0.77
1001-0406	ST 1/4"QC X 3/8"MPT	\$1.32	\$1.20	\$1.08
1001-0602	ST 3/8"QC X 1/8"MPT	\$1.33	\$1.21	\$1.09
1001-0604	ST 3/8"QC X 1/4"MPT	\$1.84	\$1.67	\$1.50
1001-0606	ST 3/8"QC X 3/8"MPT	\$5.50	\$5.00	\$4.50
1001-0608	ST 3/8"QC X 1/2"MPT	\$3.08	\$2.80	\$2.52
1001-0806	ST 1/2"QC X 3/8"MPT	\$4.64	\$4.22	\$3.80
1001-0808	ST 1/2"QC X 1/2"MPT	\$3.22	\$2.93	\$2.64
1001-0408	ST 1/4"QC X 1/2"MPT	\$2.79	\$2.54	\$2.29

Part #	Description	1+	100+	200+
1001-0404	ST 1/4"QC X 1/4"MPT	\$1.34	\$1.22	\$1.10

Faucet Connectors



(1010-0604)

Part #	Description	1+	100+	500+
1010-0401	ST 1/4"QC X 7/16" UNS	\$1.51	\$1.38	\$1.24
1010-0404	ST 1/4"QC X 1/4"NPTF	\$2.90	\$2.64	\$2.38
1010-0604	ST 3/8"QC X 1/4"NPTF	\$5.98	\$5.44	\$4.89

Reducing Stem



(1014R-0604)

Part #	Description	1+	100+	500+
1014R-0604	ST 3/8" X 1/4"	\$4.06	\$3.69	\$3.32

Union Connectors



(1015-04)

Part #	Description	1+	100+	500+
1015-04	ST 1/4"	\$1.63	\$1.48	\$1.33
1015-06	ST 3/8"	\$2.16	\$1.96	\$1.77
1015-08	ST 1/2"	\$2.10	\$1.91	\$1.72

Reducing Union



(1015R-0604)

Part #	Description	1+	100+	500+
1015R-0604	ST 3/8" X 1/4"	\$4.67	\$4.24	\$3.82
1015R-0806	ST 1/2" X 3/8"	\$4.70	\$4.28	\$3.85

Union Elbow



(1017-04)

Part #	Description	1+	100+	500+
1017-04	ST 1/4"	\$2.18	\$1.98	\$1.78
1017-06	ST 3/8"	\$2.44	\$2.22	\$1.99
1017B-08	ST 1/2"	\$5.76	\$5.24	\$4.71

Reducing Union Elbow



(1017R-0604)

Part #	Description	1+	100+	500+
1017R-0604	ST 3/8" QC X 1/4" QC	\$2.47	\$2.24	\$2.02

Stackable Elbow



(1018-06)

Part #	Description	1+	100+	500+
1018-04	ST 1/4"	\$1.42	\$1.29	\$1.16
1018-06	ST 3/8"	\$2.77	\$2.52	\$2.27
1018-08	ST 1/2"	\$3.04	\$2.76	\$2.49

Fittings / Components



WATTS® AquaLock™



(1019-0402)

Male Elbow

Part #	Description	1+	100+	500+
1019-0402	ST 1/4" QC X 1/8" NPTF	\$3.16	\$2.87	\$2.59
1019-0404	ST 1/4" QC X 1/4" NPTF	\$4.63	\$4.21	\$3.79
1019-0406	ST 1/4" QC X 3/8" NPTF	\$1.40	\$1.28	\$1.15
1019-0604	ST 3/8" QC X 1/4" NPTF	\$2.00	\$1.82	\$1.64
1019-0606	ST 3/8" QC X 3/8" NPTF	\$2.03	\$1.84	\$1.66
1019-0806	ST 1/2" QC X 3/8" NPTF	\$3.29	\$2.99	\$2.69
1019-0808	ST 1/2" QC X 1/2" NPTF	\$3.39	\$3.08	\$2.78



(1023-04)

Union Tee

Part #	Description	1+	100+	500+
1023-04	ST 1/4"	\$5.63	\$5.11	\$4.60
1023-06	ST 3/8"	\$6.17	\$5.61	\$5.05
1023B-08	ST 1/2"	\$5.56	\$5.06	\$4.55



(1024R-060604)

Reducing Tee

Part #	Description	1+	100+	500+
1024R-060604	ST 3/8 X 3/8 X 1/4	\$3.23	\$2.94	\$2.65



(1027-0604)

Male Stem

Part #	Description	1+	100+	500+
1027-0402	ST 1/4" OD X 1/8" MPT	\$0.93	\$0.85	\$0.76
1027-0604	ST 3/8" OD X 1/4" MPT	\$0.96	\$0.87	\$0.79
1027-0606	ST 3/8" OD X 3/8" MPT	\$0.94	\$0.86	\$0.77
1027-0806	ST 1/2" OD X 3/8" MPT	\$1.07	\$0.97	\$0.87



(1045-04)

End Stop

Part #	Description	1+	400+	4000+
1045-04	ST 1/4" QC	\$2.14	\$1.94	\$1.75

Fittings / Components

AquaLock™ BALL VALVES



WATTS® AquaLock™

AquaLock™ 10 Series Ball Valves are manufactured in polypropylene and are made from FDA approved materials and certified to NSF-61. They are ideal for POU installations, drinking water systems, beverage service and water filtration applications.



(1062-04)

Male Stop Valve

Part #	Description	1+	100+	500+
1062-04	ST 1/4" QC X 1/4" MPT	\$4.10	\$3.73	\$3.35
1062-06	ST 3/8" QC X 3/8" MPT	\$3.57	\$3.25	\$2.92



(1053-0604)

Female Angle Stop Valve

Part #	Description	1+	100+	500+
1053-0404	ST 1/4" QC X 1/4" FPT	\$6.13	\$5.57	\$5.01
1053-0604	ST 3/8" QC X 1/4" FPT	\$6.19	\$5.63	\$5.07



(1039-06)

Union Stop Valve

Part #	Description	1+	100+	500+
1039-04	ST 1/4" QC	\$9.13	\$8.30	\$7.47
1039-06	ST 3/8" QC	\$5.69	\$5.17	\$4.66



AQUALOCK™ LARGE DIAMETER FITTINGS



AquaLock™ Fittings can be connected to:
Copper, CPVC, PEX, LDPE, MDPE, HDPE and Polypropylene tubing.

POLYPROPYLENE TUBING SIZE OUTSIDE DIAMETER [OD]

- 3/8" O.D
- 1/2" O.D
- 5/8" O.D
- 7/8" O.D
- 1 1/8" O.D

COPPER TUBE SIZE INSIDE DIAMETER [ID]

- 1/4" CTS NOT AVAILABLE
- 3/8" CTS
- 1/2" CTS
- 3/4" CTS
- 1" CTS

CTS = Copper tube size
 NPT = National pipe tapered thread standard [MIP or FIP]
 NPS = National pipe straight thread standard [IPS]
 MGHT = Male garden hose thread
 FGHT = Female garden hose thread
 CLOSET = Toilet or ball cock connection
 HB = Hose barbed



(3501-1008)

Male Connector

Part #	Description	1+	120+	1200+
3501-0808	3/8" CTS X 1/2" NPT	\$2.77	\$2.52	\$2.27
3501-1008	1/2" CTS X 1/2" NPT	\$5.54	\$5.04	\$4.54
3501-1012	1/2" CTS X 3/4" NPS	\$5.40	\$4.91	\$4.42
3501-1014	1/2" CTS X 3/4" MGHT	\$7.29	\$6.63	\$5.97
3501-1412	3/4" CTS x 3/4" NPT	\$5.58	\$5.07	\$4.57
3501-1816	1" CTS x 1" NPT	\$7.40	\$6.73	\$6.06



(3519-1008)

Male Elbow

Part #	Description	1+	100+	1000+
3519-1008	1/2" CTS X 1/2" NPT	\$4.96	\$4.51	\$4.06
3519-1816	1" CTS X 1" NPT	\$8.98	\$8.16	\$7.35



(3530-1008)

Male Thread Tee

Part #	Description	1+	60+	600+
3530-1008	1/2" CTS X 1/2" NPT	\$8.35	\$7.59	\$6.83



(3510-1008)

Female Connector

Part #	Description	1+	120+	1200+
3510-0808	3/8" CTS X 1/2" NPS	\$5.19	\$4.72	\$4.25
3510-1008	1/2" CTS X 1/2" NPS	\$7.58	\$6.89	\$6.21
3510-1013	1/2" CTS X 3/4" CLOSET	\$9.19	\$8.35	\$7.52
3510-1012	1/2" CTS X 3/4" NPS	\$9.37	\$8.52	\$7.67
3510-1014	1/2" CTS X 3/4" FGHT	\$7.05	\$6.41	\$5.77
3510-1412	3/4" CTS x 3/4" NPS	\$6.42	\$5.83	\$5.25

Fittings / Components



Female Swivel Elbow

Part #	Description	1+	80+	800+
3520-0808	3/8" CTS X 1/2" NPS	\$4.55	\$4.14	\$3.73
3520-1008	1/2" CTS X 1/2" NPS	\$5.87	\$5.34	\$4.80
3520-1012	1/2" CTS X 3/4" NPS	\$5.95	\$5.41	\$4.87
3520-1014	1/2" CTS X 3/4" FGHT	\$4.29	\$3.90	\$3.51



Hose Barb Fitting

Part #	Description	1+	130+	1300+
3513-1008	1/2" CTS X 1/2" H.B.	\$5.98	\$5.44	\$4.89



Drop Ear Elbow

Part #	Description	1+	80+	800+
3521-1008	1/2" CTS X 1/2" NPT	\$6.45	\$5.86	\$5.28

(3521-1008)

Union Connector

Part #	Description	1+	100+	1000+
3515-08	3/8" CTS	\$2.76	\$2.51	\$2.26
3515-10	1/2" CTS	\$5.40	\$4.91	\$4.42
3515-14	3/4" CTS	\$8.99	\$8.18	\$7.36
3515-18	1" CTS	\$11.05	\$10.04	\$9.04



(3515-10)

Union Elbow

Part #	Description	1+	100+	1000+
3517-08	3/8" CTS	\$3.88	\$3.52	\$3.17
3517-10	1/2" CTS	\$4.91	\$4.47	\$4.02
3517-14	3/4" CTS	\$7.67	\$6.97	\$6.27
3517-18	1" CTS	\$12.76	\$11.60	\$10.44



(3517-10)

Union Tee

Part #	Description	1+	80+	800+
3523-08	3/8" CTS	\$3.23	\$2.94	\$2.65
3523-10	1/2" CTS	\$6.53	\$5.94	\$5.34
3523-14	3/4" CTS	\$10.71	\$9.74	\$8.76
3523-18	1" CTS	\$15.87	\$14.43	\$12.99



(3523-10)

Stackable Elbow

Part #	Description	1+	120+	1200+
3518-08	3/8" CTS	\$1.78	\$1.62	\$1.46
3518-10	1/2" CTS	\$4.59	\$4.17	\$3.75
3518-14	3/4" CTS	\$5.95	\$5.41	\$4.87
3518-18	1" CTS	\$9.17	\$8.34	\$7.50



(3518-10)



(3533-10)

Stackable Tee

Part #	Description	1+	80+	800+
3533-08	3/8" CTS	\$4.36	\$3.96	\$3.57
3533-10	1/2" CTS	\$7.91	\$7.19	\$6.47
3533-14	3/4" CTS	\$8.37	\$7.61	\$6.85
3533-18	1" CTS	\$10.35	\$9.41	\$8.47



(3534-10)

Stackable Branch Tee

Part #	Description	1+	50+	500+
3534-10	1/2" CTS	\$6.50	\$5.91	\$5.32



(3511-1008)

Stackable Hose Barb Union

Part #	Description	1+	200+	2000+
3511-1008	1/2" CTS X 1/2" H.B.	\$4.23	\$3.85	\$3.46



(3512-1008)

Stackable Hose Barb Elbow

Part #	Description	1+	200+	2000+
3512-1008	1/2" CTS X 1/2" H.B.	\$2.05	\$1.86	\$1.67

Reducing Tee

Part #	Description	1+	30+	300+
3524-1410	3/4" CTS X 1/2" CTS	\$8.93	\$8.12	\$7.31

Reducing Stackable Tee

Part #	Description	1+	50+	500+
3533R-1004	1/2" CTS X 1/4" OD	\$8.55	\$7.77	\$7.00

Reducing Branch Tee

Part #	Description	1+	30+	300+
3524R-1410	3/4" CTS X 1/2" CTS	\$9.90	\$9.00	\$8.10
3524R-1814	1" CTS X 3/4" OD	\$13.32	\$12.11	\$10.90
3524R-1004	1/2" CTS X 1/4" OD	\$9.20	\$8.37	\$7.53



(3524R-1814)

Reducing Union

Part #	Description	1+	50+	500+
3515R-1004	1/2" CTS X 1/4" OD	\$7.33	\$6.66	\$6.00
3515R-1008	1/2" CTS X 3/8" CTS	\$4.57	\$4.15	\$3.74



(3515R-1008)

Reducing Stem

Part #	Description	1+	100+	1000+
3514-1410	3/4" CTS X 1/2" CTS	\$4.41	\$4.01	\$3.61
3514-1008	1/2" CTS X 3/8" CTS	\$3.92	\$3.57	\$3.21



(3514-1410)

3 Way Selector Valve

Part #	Description	1+	20+	200+
3538-10	1/2" CTS	\$15.99	\$14.54	\$13.08



(3538-10)



3 Way By-Pass Valve

Part #	Description	1±	20±	200±
3541-10	1/2" CTS	\$23.94	\$21.77	\$19.59



(3539-10)

Stop Valve

Part #	Description	1±	40±	400±
3539-08	3/8" CTS	\$10.45	\$9.50	\$8.55
3539-10	1/2" CTS	\$9.20	\$8.37	\$7.53

Part #	Description	1±	10±	100±
3539-14	3/4" CTS	\$14.60	\$13.27	\$11.94

Part #	Description	1±	56±	506±
3539-18	1" CTS	\$16.33	\$14.84	\$13.36

Reducing Stop Valve

Part #	Description	1±	40±	400±
3539-1004	1/2" CTS X 1/4" OD	\$12.38	\$11.25	\$10.13



(3561-0604)

Angle Stop Valve

Part #	Description	1±	60±	600±
3561-0604	3/8 M COMP X 3/8 F COMP X 1/4" QC	\$12.95	\$11.77	\$10.59
3561-0606	3/8 M COMP X 3/8 F COMP X 3/8" QC	\$13.11	\$11.91	\$10.72



(3543-10)

Stackable Valve

Part #	Description	1±	40±	400±
3543-10	1/2" CTS	\$9.77	\$8.88	\$7.99

Reducing Stackable Valve

Part #	Description	1±	40±	400±
3543-1004	1/2" CTS X 1/4" OD	\$6.49	\$5.90	\$5.31



(3540-10)

Union Check Valve

Part #	Description	1±	90±	450±
3540-10	1/2" CTS	\$7.25	\$6.59	\$5.93



(3545-10)

End Stop

Part #	Description	1±	200±	2000±
3545-10	1/2" CTS	\$5.00	\$4.54	\$4.09

Part #	Description	1±	90±	900±
3545-14	3/4" CTS	\$6.13	\$5.57	\$5.01

Collect Clip

Part #	Description	1±	250±	2500±
3547-08	3/8" CTS	\$0.10	\$0.10	\$0.09
3547-10	1/2" CTS	\$0.15	\$0.14	\$0.12
3547-14	3/4" CTS	\$0.12	\$0.11	\$0.10



(3547-10)

Union Pump Fitting

Part #	Description	1±	120±	1200±
3575-10	1/2" CTS	\$2.31	\$2.10	\$1.89



(3575-10)

Elbow Pump Fitting

Part #	Description	1±	100±	1000±
3576-10	1/2" CTS	\$5.54	\$5.04	\$4.54



(3576-10)

Fittings / Components



JACO® FITTINGS



Please Choose Fitting Material: Parts shown are made of Nylon [N], the [O] means the fitting comes with a Ferrule nut with integrated sleeve.

Call for pricing on other materials available; Polypropylene [P], Celcon [C] and Kynar [K] and fittings with Plastic grippers [PG] or Stainless steel grippers [SG]

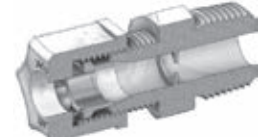
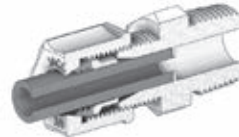

O
Ferrule Nut with integral sleeve low pressure applications soft plastic tubing *50 p.s.i.

PG
Nut with Plastic Gripper for use with plastic tubing for sure grip *220 p.s.i.

SG
Nut with Stainless Steel Gripper for use with hard and smooth surfaced tubing *220 p.s.i.



Male Connector

Male Connectors

Part #	Description	1+	200+	1000+	2000+
1042NO	1/4" X 1/8"	\$0.58	\$0.46	\$0.42	\$0.39
1044NO	1/4" X 1/4"	\$0.63	\$0.51	\$0.47	\$0.42
1046NO	1/4" X 3/8"	\$0.65	\$0.52	\$0.48	\$0.43
Part #	Description	1+	100+	500+	1000+
1062NO	3/8" X 1/8"	\$0.75	\$0.60	\$0.55	\$0.50
1064NO	3/8" X 1/4"	\$0.76	\$0.61	\$0.56	\$0.51
1066NO	3/8" X 3/8"	\$0.84	\$0.67	\$0.62	\$0.56
1068NO	3/8" X 1/2"	\$1.03	\$0.83	\$0.76	\$0.69
1084NO	1/2" X 1/4"	\$1.32	\$1.06	\$0.97	\$0.88
1086NO	1/2" X 3/8"	\$1.03	\$0.83	\$0.76	\$0.69
1088NO	1/2" X 1/2"	\$1.10	\$0.88	\$0.81	\$0.74



Union Connector

Unions

Part #	Description	1+	200+	1000+	2000+
154NO	1/4"	\$0.84	\$0.67	\$0.62	\$0.56
Part #	Description	1+	100+	500+	1000+
156NO	3/8"	\$1.20	\$0.96	\$0.88	\$0.80
158NO	1/2"	\$1.56	\$1.25	\$1.15	\$1.04



Reducing Union Connector

Reducing Unions

Part #	Description	1+	200+	1000+	2000+
1542NO	1/4" X 1/8"	\$0.84	\$0.67	\$0.62	\$0.56
Part #	Description	1+	100+	500+	1000+
1564NO	3/8" X 1/4"	\$1.10	\$0.88	\$0.81	\$0.74
1586NO	1/2" X 3/8"	\$1.39	\$1.11	\$1.02	\$0.93



Bulkhead Union

Bulkhead Union Connectors

Part #	Description	1+	200+	1000+	2000+
204NO	1/4" X 1/4"	\$1.25	\$1.00	\$0.91	\$0.83
Part #	Description	1+	100+	500+	1000+
206NO	3/8" X 3/8"	\$1.61	\$1.29	\$1.18	\$1.08
208NO	1/2" X 1/2"	\$2.14	\$1.72	\$1.57	\$1.43

[N] Nylon has good resistance to organic solvents, oils and gasoline. Good strength at high temperatures. Cold and hot water applications. Longtime weathering resistance. Good impact resistance, both single and repeated. Not recommended for use with ammonium, boric acid, calcium, sulfuric acid, or hydrochloric acid. F.D.A. listed. Also N.S.F. listed.

[C] Celcon or acetal copolymer, has high tensile strength and good impact resistance over a broad temperature range. Translucent white color. Not affected by continuous hot-water service and works smoothly with metal tubing. Celcon is not recommended for continuous exposure to solutions with a chlorine concentration greater than 1 ppm. Suggested maximum continuous temperature is 220°F in air and 180°F in water.

Fittings / Components



Please Choose Fitting Material: Parts shown are made of Nylon [N], the [O] means the fitting comes with a Ferrule nut with integrated sleeve.

Call for pricing on other materials available; Polypropylene [P], Celcon [C] and Kynar [K]" and fittings with Plastic grippers [PG] or Stainless steel grippers [SG]



Female Connector

Female Connectors

Part #	Description	1+	200+	1000+	2000+
2542NO	1/4" X 1/8"	\$0.78	\$0.62	\$0.57	\$0.52
2544NO	1/4" X 1/4"	\$0.80	\$0.64	\$0.59	\$0.53

Part #	Description	1+	100+	500+	1000+
2564NO	3/8" X 1/4"	\$0.98	\$0.79	\$0.72	\$0.66
2566NO	3/8" X 3/8"	\$1.01	\$0.81	\$0.74	\$0.67
2568NO	3/8" X 1/2"	\$1.16	\$0.93	\$0.85	\$0.77
2586NO	1/2" X 3/8"	\$1.14	\$0.91	\$0.84	\$0.76
2588NO	1/2" X 1/2"	\$1.24	\$0.99	\$0.91	\$0.83



Male Elbow

Male Elbow Connectors

Part #	Description	1+	200+	1000+	2000+
4042NO	1/4" X 1/8"	\$0.89	\$0.71	\$0.65	\$0.59
4044NO	1/4" X 1/4"	\$0.90	\$0.72	\$0.66	\$0.60
4046NO	1/4" X 3/8"	\$1.08	\$0.86	\$0.79	\$0.72

Part #	Description	1+	100+	500+	1000+
4064NO	3/8" X 1/4"	\$1.13	\$0.91	\$0.83	\$0.76
4066NO	3/8" X 3/8"	\$1.18	\$0.95	\$0.87	\$0.79
4084NO	1/2" X 1/4"	\$1.25	\$1.00	\$0.92	\$0.84
4086NO	1/2" X 3/8"	\$1.37	\$1.10	\$1.01	\$0.92
4088NO	1/2" X 1/2"	\$1.38	\$1.11	\$1.01	\$0.92



Female Elbow

Female Elbow Connectors

Part #	Description	1+	200+	1000+	2000+
4542NO	1/4" X 1/8"	\$1.16	\$0.93	\$0.85	\$0.77
4544NO	1/4" X 1/4"	\$1.18	\$0.95	\$0.87	\$0.79

Part #	Description	1+	100+	500+	1000+
4564NO	3/8" X 1/4"	\$1.43	\$1.14	\$1.05	\$0.95
4566NO	3/8" X 3/8"	\$1.62	\$1.30	\$1.19	\$1.08
4586NO	1/2" X 3/8"	\$1.88	\$1.51	\$1.38	\$1.26
4588NO	1/2" X 1/2"	\$2.18	\$1.75	\$1.60	\$1.46



Union Elbow

Union Elbow Connectors

Part #	Description	1+	200+	1000+	2000+
504NO	1/4"	\$1.17	\$0.94	\$0.86	\$0.78

Part #	Description	1+	100+	500+	1000+
506NO	3/8"	\$1.61	\$1.29	\$1.18	\$1.08
508NO	1/2"	\$1.98	\$1.58	\$1.45	\$1.32



Male Branch Tee

Male Branch Tees

Part #	Description	1+	200+	1000+	2000+
6042NO	1/4" X 1/4" X 1/8"	\$1.20	\$0.96	\$0.88	\$0.80
6044NO	1/4" X 1/4" X 1/4"	\$1.47	\$1.18	\$1.08	\$0.98

Part #	Description	1+	100+	500+	1000+
6064NO	3/8" X 3/8" X 1/4"	\$1.72	\$1.38	\$1.26	\$1.15
6066NO	3/8" X 3/8" X 3/8"	\$1.77	\$1.42	\$1.30	\$1.18
6086NO	1/2" X 1/2" X 3/8"	\$2.26	\$1.81	\$1.66	\$1.51
6088NO	1/2" X 1/2" X 1/2"	\$2.32	\$1.86	\$1.70	\$1.55



Union Tee

Union Tees

Part #	Description	1+	200+	1000+	2000+
704NO	1/4"	\$1.47	\$1.18	\$1.08	\$0.98

Part #	Description	1+	100+	500+	1000+
706NO	3/8"	\$2.02	\$1.62	\$1.49	\$1.35
708NO	1/2"	\$2.44	\$1.95	\$1.79	\$1.63

[P] Polypropylene has good chemical resistance. Withstands continuous temperatures up to 215°F. Opaque color. Unaffected by most weak acids and alkalis. Below 175°F it has good resistance to organic solvents. Do not use with oxidants or strong acids or in continuous sunlight. N.S.F. listed. 20% glass filled for improved stiffness.

[K] Kynar polyvinylidene fluoride, has outstanding chemical resistance for handling highly corrosive fluids. F.D.A. N.S.F. Listed.

Fittings / Components



Please Choose Fitting Material: Parts shown are made of Nylon [N], the [O] means the fitting comes with a Ferrule nut with integrated sleeve.

Call for pricing on other materials available; Polypropylene [P], Celcon [C] and Kynar [K]" and fittings with Plastic grippers [PG] or Stainless steel grippers [SG]



Male Run Tee

Male Run Tees

Part #	Description	1±	200±	1000±	2000±
7542NO	1/4" X 1/8"	\$1.20	\$0.96	\$0.88	\$0.80
7544NO	1/4" X 1/4"	\$1.47	\$1.18	\$1.08	\$0.98
Part #	Description	1±	100±	500±	1000±
7564NO	3/8" X 1/4"	\$1.72	\$1.38	\$1.26	\$1.15
7566NO	3/8" X 3/8"	\$1.77	\$1.42	\$1.30	\$1.18
7586NO	1/2" X 3/8"	\$2.26	\$1.81	\$1.66	\$1.51
7588NO	1/2" X 1/2"	\$2.32	\$1.86	\$1.70	\$1.55



Check Valve

KYNAR Check Valves

Part #	Description	1±	25±	125±	250±
CV-2-K	1/8"	\$10.06	\$8.05	\$7.38	\$6.71
CV-4-K	1/4"	\$10.71	\$8.57	\$7.85	\$7.14
CV-6-K	3/8"	\$11.41	\$9.13	\$8.37	\$7.61
CV-8-K-EP	1/2" EP O-RING	\$12.88	\$10.31	\$9.45	\$8.59
Part #	Description	1±	10±	25±	50±
CV-8-K	1/2"	\$12.88	\$10.30	\$9.44	\$8.59



Ferrule Nut

Ferrule Nuts with Integral Sleeve

Part #	Description	1±	200±	1000±	2000±
NO2	1/8"	\$0.24	\$0.20	\$0.18	\$0.16
NO4	1/4"	\$0.27	\$0.21	\$0.20	\$0.18
NO4-BK	1/4" - BLACK	\$0.29	\$0.23	\$0.21	\$0.20
Part #	Description	1±	100±	500±	1000±
NO6	3/8"	\$0.38	\$0.30	\$0.28	\$0.25
NO6-BK	3/8" - BLACK	\$0.39	\$0.32	\$0.29	\$0.26
NO8	1/2"	\$0.46	\$0.37	\$0.34	\$0.31

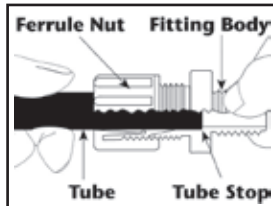

Ferrule Nuts with Plastic Gripper

Part #	Description	1±	200±	1000±	2000±
NPG4	1/4"	\$0.44	\$0.35	\$0.33	\$0.30
NPG4-BK	1/4" - BLACK	\$0.47	\$0.37	\$0.34	\$0.31
NPG6	3/8"	\$0.55	\$0.44	\$0.41	\$0.37
NPG8	1/2"	\$0.68	\$0.55	\$0.50	\$0.46



Derlin Sleeve

Derlin Sleeve

Part #	Description	1±	100±	1000±	
DS14	1/4" DELRIN SLEEVE/FERRULE	\$0.20	\$0.16	\$0.13	
DS38	3/8" DELRIN SLEEVE/FERRULE	\$0.24	\$0.18	\$0.15	
Part #	Description	1±	100±	500±	1000±
FER12HL	1/2" DELRIN SLEEVE/FERRULE	\$0.78	\$0.66	\$0.62	\$0.59



Insert

Inserts

Part #	Description	1±	100±	500±	1000±
NP4	1/4"	\$0.12	\$0.09	\$0.09	\$0.08
NP6	3/8"	\$0.16	\$0.13	\$0.12	\$0.11
NP8	1/2"	\$0.20	\$0.16	\$0.15	\$0.14

BRASS FITTINGS - LEAD FREE



Tubing Insert

Brass Fittings - Lead Free

Part #	Description	1±	50±	100±	300±
700561-04	1/4" TUBING INSERT LEAD FREE	\$0.51	\$0.46	\$0.44	\$0.41
700561-06	3/8" TUBING INSERT LEAD FREE	\$0.56	\$0.50	\$0.48	\$0.45
700561-08	1/2" TUBING INSERT LEAD FREE	\$1.73	\$1.55	\$1.49	\$1.38
700060-04	1/4" SLEEVE; BRASS; LEAD FREE	\$0.26	\$0.23	\$0.22	\$0.21
700060-06	3/8" SLEEVE; BRASS; LEAD FREE	\$0.39	\$0.35	\$0.33	\$0.31
700061-04	1/4" COMP NUT BRASS LEAD FREE	\$1.00	\$0.90	\$0.86	\$0.80
700061-06	3/8" COMP. NUT BRASS LEAD FREE	\$1.29	\$1.17	\$1.12	\$1.04



Sleeve



HYPRO - NIPPLES, REDUCING BUSHINGS AND HOSEBARB FITTINGS



Nylon Hex Nipple

Nylon Hex Nipples

Part #	Description	1+	50+	250+	500+
M14	1/4" M. PIPE NIPPLE; N	\$0.56	\$0.49	\$0.45	\$0.43
M38	3/8" M. PIPE NIPPLE; N	\$0.53	\$0.46	\$0.42	\$0.40
M12	1/2" M. PIPE NIPPLE; N	\$0.63	\$0.54	\$0.50	\$0.48
M34	3/4" M. PIPE NIPPLE; N	\$0.74	\$0.65	\$0.60	\$0.57
M100	1" M. PIPE NIPPLE; N	\$1.19	\$1.03	\$0.95	\$0.91
M112	1.5" M. PIPE NIPPLE; N	\$3.82	\$3.31	\$3.06	\$2.91
M3818	3/8" X 1/8" M. REDUCING NIPPLE; N	\$0.42	\$0.36	\$0.34	\$0.32
M3814	3/8" X 1/4" M. REDUCING NIPPLE; N	\$0.55	\$0.47	\$0.44	\$0.42
M1218	1/2" X 1/8" M. REDUCING NIPPLE; N	\$0.55	\$0.48	\$0.44	\$0.42
M1214	1/2" X 1/4" M. REDUCING NIPPLE; N	\$0.70	\$0.61	\$0.56	\$0.54
M1238	1/2" X 3/8" M. REDUCING NIPPLE; N	\$0.66	\$0.57	\$0.53	\$0.50
M3438	3/4" X 3/8" M. REDUCING NIPPLE; N	\$0.54	\$0.47	\$0.43	\$0.41
M3412	3/4" X 1/2" M. REDUCING NIPPLE; N	\$0.71	\$0.62	\$0.57	\$0.54



Polypropylene Nipple (3M12G)

Polypropylene Hex Nipples

Part #	Description	1+	50+	250+	500+
3M14G	1/4" M. PIPE NIPPLE-P/BLACK	\$0.54	\$0.47	\$0.43	\$0.41
3M38G	3/8" M. PIPE NIPPLE-P/BLACK	\$0.64	\$0.56	\$0.51	\$0.49
3M12G	1/2" M. PIPE NIPPLE-P/BLACK	\$0.66	\$0.57	\$0.53	\$0.50
3M34G	3/4" M. PIPE NIPPLE-P/BLACK	\$0.81	\$0.70	\$0.65	\$0.62

Hosebarb Elbow Hex Connectors

Part #	Description	1+	50+	250+	500+
EL14	1/4" MPT X 1/4" HB ELBOW; N	\$0.81	\$0.70	\$0.65	\$0.62
EL1438	1/4" MPT X 3/8" HB ELBOW; N	\$0.83	\$0.72	\$0.67	\$0.63
3EL1438G	1/4" MPT X 3/8" HB ELBOW; BLACK	\$0.91	\$0.79	\$0.73	\$0.69
EL1412	1/4" MPT X 1/2" HB ELBOW; N	\$0.90	\$0.78	\$0.72	\$0.69
EL3812	3/8" MPT X 1/2" HB ELBOW; N	\$0.89	\$0.77	\$0.71	\$0.68
EL1238	1/2" MPT X 3/8" HB ELBOW; N	\$0.90	\$0.78	\$0.72	\$0.69
EL3412F	3/4" FPT X 1/2" HB ELBOW; N	\$2.57	\$2.23	\$2.06	\$1.96
EL34	3/4" MPT X 3/4" HB ELBOW; N	\$1.12	\$0.97	\$0.90	\$0.85



Hosebarb Elbow (EL34)

Part #	Description	1+	25+	125+	250+
EL38	3/8" MPT X 3/8" HB ELBOW; N	\$0.85	\$0.74	\$0.68	\$0.65
EL3412	3/4" MPT X 1/2" HB ELBOW; N	\$1.21	\$1.05	\$0.97	\$0.92
EL12	1/2" MPT X 1/2" HB ELBOW; N	\$1.01	\$0.87	\$0.81	\$0.77

Reducing Bushings

Part #	Description	1+	50+	250+	500+
RB10012	1"X1/2" REDUCING BUSHING;N	\$2.45	\$2.13	\$1.96	\$1.87
RB10034	1"X3/4" REDUCING BUSHING;N	\$2.38	\$2.07	\$1.91	\$1.81
RB112114	1 1/2"X1 1/4" REDUCING BUSHING;N	\$3.96	\$3.44	\$3.17	\$3.01
RB11234	1 1/2"X3/4" RED. BUSHING; N	\$4.85	\$4.21	\$3.88	\$3.69
RB11434	1 1/4"X3/4" RED. BUSHING;N	\$3.33	\$2.89	\$2.66	\$2.53
RB1214	1/2X1/4 REDUCING BUSHING;N	\$1.19	\$1.03	\$0.95	\$0.91
RB1238	1/2X3/8 REDUCING BUSHING;N	\$2.07	\$1.80	\$1.66	\$1.58
RB3412	3/4X1/2 REDUCING BUSHING;N	\$1.31	\$1.13	\$1.05	\$1.00
RB3414	3/4X1/4 REDUCING BUSHING;N	\$1.39	\$1.20	\$1.11	\$1.06
RB3438	3/4X3/8 REDUCING BUSHING;N	\$1.33	\$1.16	\$1.07	\$1.01
RB3814	3/8X1/4 REDUCING BUSHING;N	\$1.05	\$0.91	\$0.84	\$0.80
RB3814B	3/8X1/4 REDUCING BUSHING;BRASS	\$1.65	\$1.43	\$1.32	\$1.26



Reducing Bushing

Part #	Description	1+	25+	125+	250+
RB112100	1 1/2"X1" REDUCING BUSHING;N	\$4.14	\$3.59	\$3.31	\$3.15
RB114100	1 1/4"X1" RED. BUSHING;N	\$2.95	\$2.55	\$2.36	\$2.24

Part #	Description	1+	25+	100+
RB1418	1/4X1/8 REDUCING BUSHING;N	\$0.56	\$0.52	\$0.49



SMC® BALL VALVES



SMC® = Quick Connect Style Fitting



658 Series

PVC Tank Ball Valves - 658 Series

Part #	Description	1±	10±	150±
7070490	1/4" FPT X 1/4" SMC; WHITE	\$7.77	\$7.25	\$6.74
7070590	1/4" FPT X 3/8" SMC; WHITE	\$4.89	\$4.57	\$4.24



657 Series Ball Valves

PVC Right Angled Ball Valves - 657 Series

Part #	Description	1±	10±	150±
6570090	1/4" FPT X 1/4" JACO-B; NSF	\$6.64	\$6.20	\$5.76
6570190	1/4" FPT X 1/4" FPT-B; NSF	\$6.21	\$5.79	\$5.38
6571390	1/4" FPT X 1/4" SMC-B; NSF	\$7.60	\$7.09	\$6.58
6570590	1/4" FPT X 3/8" JACO-B; NSF	\$6.51	\$6.07	\$5.64
6571290	1/4" FPT X 3/8" SMC-B; NSF	\$7.73	\$7.22	\$6.70
6571190	1/4" FPT X TAPERED BARB-B; NSF	\$6.45	\$6.02	\$5.59
6571890	3/8" SMC X 3/8" SMC-B;	\$9.69	\$9.04	\$8.40
6572690	3/8" FPT X 3/8" SMC-B; NSF	\$7.73	\$7.22	\$6.70
6573590	3/8" MPT X 3/8" SMC-B; NSF	\$7.73	\$7.22	\$6.70



250 Series

PVC Inline Ball Valves - 250 Series

Part #	Description	1±	10±	150±
2270090	1/2" FPT X 1/2" FPT-BUNA SEAL	\$17.00	\$15.87	\$14.74
2270190	1/2" MPT X 1/2" MPT-BUNA SEAL	\$15.87	\$14.82	\$13.76
2270790	1/2" FPT X 1/2" MPT-BUNA SEAL	\$15.87	\$14.82	\$13.76



638 Series

PVC Inline Ball Valves - 638 Series

Part #	Description	1±	10±	150±
6380090	1/4" FPT X 1/4" FPT-B; NSF	\$5.28	\$4.92	\$4.57
6380490	1/4" MPT X 1/4" FPT-B; NSF	\$5.28	\$4.92	\$4.57
6381090	1/4" JACO X 1/4" FPT-B; NSF	\$5.73	\$5.35	\$4.97
6385190	1/4" MPT X 1/4" SMC-B; NSF	\$7.24	\$6.76	\$6.27
6382090	1/4" SMC X 3/8" FPT-B; NSF	\$7.88	\$7.36	\$6.83
6383890	1/4" MPT X 3/8" SMC-B; NSF	\$6.87	\$6.42	\$5.96
6381290	3/8" MPT X 1/4" FPT-B; NSF	\$4.93	\$4.60	\$4.27
6382990	3/8" SMC X 1/4" SMC-B; NSF	\$9.31	\$8.69	\$8.07
6381890	3/8" SMC X 3/8" SMC-B; NSF	\$9.45	\$8.82	\$8.19
6382590	3/8" JACO X 3/8" FPT-B; NSF	\$5.34	\$4.98	\$4.63
6382890	3/8" FPT X 3/8" FPT-B; NSF	\$5.28	\$4.92	\$4.57
6383990	3/8" FPT X 3/8" SMC-B; NSF	\$6.87	\$6.42	\$5.96
6381790	1/4" SMC X 1/4" SMC-B; NSF	\$9.16	\$8.55	\$7.94
6383190	1/4" FPT X 3/8" SMC-B; NSF	\$7.36	\$6.87	\$6.38

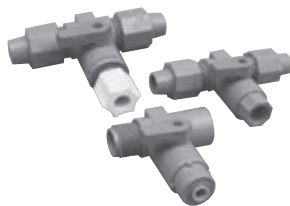

689 Series Ball Valves

T-Link PVC Ball Valves - 689 Series

Part #	Description	1±	10±	150±
6890590	1/2" FPT X 1/2" MPT X 1/4" FPT; NSF	\$8.56	\$7.99	\$7.42
6891190	1/2" FPT X 1/2" MPT X 1/4" JACO; NSF	\$9.12	\$8.51	\$7.90
6892390	1/2" FPT X 1/2" MPT X 1/4" SMC; NSF	\$10.51	\$9.81	\$9.11
6890690	4 QEST X 4 QEST X 1/4" JACO; NSF	\$11.91	\$11.12	\$10.33
6891890	4 QEST X 4 QEST X 1/4" SMC; NSF	\$16.11	\$15.04	\$13.96
6890190	6 QEST X 6 QEST X 1/4" FPT; NSF	\$14.16	\$13.22	\$12.28
6890790	6 QEST X 6 QEST X 1/4" JACO; NSF	\$11.91	\$11.12	\$10.33
6891990	6 QEST X 6 QEST X 1/4" SMC; NSF	\$16.11	\$15.04	\$13.96
6892590	6 QEST X 6 QEST X 3/8" SMC; NSF	\$13.75	\$12.83	\$11.92
6890890	8 QEST X 8 QEST X 1/4" JACO; NSF	\$11.91	\$11.12	\$10.33

Poly Tube (Outside Diameter)	Copper Tube (Inside Diameter)	Use QEST Size
3/8"	1/4"	4 QEST
1/2"	3/8"	6 QEST
5/8"	1/2"	8 QEST

Fittings / Components



AQUAMOR USA CAPILLARIES



AQUAMOR



1/4" FPT Capillaries
(PFR402-___)



1/4" FQC Capillaries
(PFR402Q-___)

1/4" FPT Capillaries

Part #	Description (___ = choose ml size)	1±	10±	50±	100±
PFR402-___	120, 125, 150, 250, 280, 300, 400, 420, 450, 500, 550, 650, 700, 750, 800, 850, 900, 1000, 1100, 1200, & 1500 ML/MIN	\$5.04	\$4.73	\$4.41	\$4.10

1/4" FQC Capillaries

Part #	Description (___ = choose ml size)	1±	10±	50±	100±
PFR402Q-___	100, 125, 150, 200, 220, 250, 300, 350, 400, 420, 450, 500, 550, 600, 650, 800, 850, 1000, & 1200 ML/MIN	\$12.99	\$12.18	\$11.37	\$10.55

1/4" Male Compression Thread Capillaries

Part #	Description (___ = choose ml size)	1±	10±	50±	100±
PFR404M-___	150, 200, 250, 300, 350, 420, 500, 550, 800, & 900 ML/MIN	\$12.99	\$12.18	\$11.37	\$10.55

GWV CAPILLARIES

GWV Capillaries

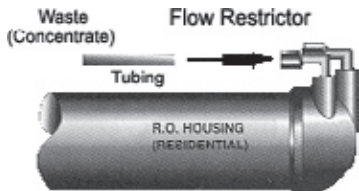

Part #	Description	1±	50±	100±
FRCT-110	110ML/MIN (10G) FRRD	\$1.79	\$1.67	\$1.56
FRCT-260	260ML/MIN (25G) FRBK	\$1.79	\$1.67	\$1.56
FRCT-365	365ML/MIN (35G) FRYL	\$1.79	\$1.67	\$1.56
FRCT-575	575ML/MIN (75G) FRBL	\$1.79	\$1.67	\$1.56
FRCT-730	730ML/MIN (100G) FRWH	\$1.79	\$1.67	\$1.56
FRCT-189	189ML/MIN (18G) FRBR	\$1.79	\$1.67	\$1.56
FRCT-525	525ML/MIN (50G) FRGN	\$1.79	\$1.67	\$1.56

HYDRONAMIC ENGINEERING® FLOW RESTRICTORS



Flow Restrictor
(FR-___)



Flow Restrictor
(FR2000JD-___)



Flow Restrictor
1/4" x 1/8" Elbow

Inline (1/8" FPT Ports, 1-1/2" length)

Part #	Description (___ = Choose ml size)	1±	25±	100±
FR-___	Available sizes: 150ml/min to 2,000ml/min in 50ml increments	\$2.88	\$2.69	\$2.50

Fittings Installation Available - Call For Details

Inline (1/4" QC)

Part #	Description (___ = Choose ml size)	1±	25±	100±
FR2000JD-___	Available sizes: 80ml/min to 2,000ml/min in 50ml increments	\$4.11	\$3.83	\$3.56

Male Connector Fitting With Insert (1/4"JG x 1/8"MPT)

Part #	Description (___ = Choose ml size)	1±	25±	100±
FR-___-CI010821	Available sizes: 150ml/min to 1000ml/min in 50ml increments	\$5.16	\$4.81	\$4.47

Fixed Elbow Fitting With Stainless Steel Insert (1/4"JG X 1/8"MPT)

Part #	Description (___ = Choose ml size)	1±	25±	100±
SFR-___-CI480821	Available sizes: 150ml/min to 1000ml/min in 50ml increments	\$4.42	\$4.12	\$3.83

Also Available: 0.5gpm, 1.0gpm, 2.0gpm in your choice of housing, fitting, or custom application.
Call Sales for pricing and availability.

Miscellaneous

Part #	Description	1±	25±	100±
FR-CLIP	FLOW RESTRICTOR CLIP	\$0.25	\$0.24	\$0.22



REVERSE OSMOSIS AUTOMATIC SHUT OFF VALVES (ASO)



(ASV-100)



(ASV-2000W)

Hydronic ASO Series - White

Part #	Description	1±	25±	100±
ASV-100	ASO; 1/8" FPT	\$6.01	\$5.61	\$5.21
ASV-100JG	ASO; 1/4" QC	\$10.19	\$9.51	\$8.83
ASV-2000W	ASO; W/ INTRA SEAL; 1/4" QC	\$8.36	\$7.80	\$7.25
ASV-ERP-JG	PERMEATE PUMP ASO 80%; 1/4" QC	\$12.06	\$11.25	\$10.45
ASV300	ASO; 3/8" QC	\$19.41	\$18.12	\$16.82



(ASV-100B)



(ASV300B)

Hydronic ASO Series - Black

Part #	Description	1±	25±	100±
ASV-100B	ASO; 1/8" FPT	\$6.01	\$5.61	\$5.21
ASV-100JG-BK	ASO; 1/4" QC	\$10.19	\$9.51	\$8.83
ASV300B	ASO; 3/8" QC	\$21.54	\$20.11	\$18.67



(ASV-4000Q)

Puregen ASO valve

Part #	Description	1±	50±	100±
ASV-4000Q	ASO; 1/4" QC WHITE	\$3.26	\$3.05	\$2.83



(PWS592Q)

Payne PWS Series

Part #	Description	1±	10±	50±	100±
PWS592Q	ASO; WHITE; 1/4" QC	\$18.18	\$17.04	\$15.91	\$14.77



(T2000)

Terminator 2000

Part #	Description	1±	10±	50±	100±
T2000	T2000 ASO; 2/3; 1/8" FPT; WH	\$7.98	\$7.11	\$6.69	\$6.37
T2000S	T2000S ASO W/SPRING; 90%; 1/8" FPT; WHITE	\$9.68	\$8.62	\$8.11	\$7.72

HYDRONAMIC ENGINEERING® CHECK VALVES



Fittings / Components



Check Valve (ILCV09)

InLine Check Valve

Part #	Description	1±	25±	100±
ILCV09	INLINE CHECK VALVE; 1/4" QC	\$6.75	\$6.30	\$5.85



Check Valve (CV18S-FM)

Stainless Steel Check Valves

Part #	Description	1±	25±	100±
CV18S-FM	1/8" MPT x 1/8" FPT SS	\$8.46	\$7.89	\$7.33
CV18SS	1/8" MPT X 1/8" MPT SS	\$7.83	\$7.31	\$6.78
CV14SF	1/4" MPT X 1/4" FPT SS	\$12.41	\$11.59	\$10.76
CV14SF-V	1/4" MPT X 1/4" FPT SS; VITON	\$11.60	\$10.82	\$10.05
CV14S	1/4" MPT X 1/4" MPT SS	\$14.38	\$13.42	\$12.46



Check Valve (CV14S)

Stainless Steel Check Valve - Inserted into Jaco Fittings

Part #	Description	1±	25±	100±
SCV-1042NO	CV;1/4" JACO X 1/8" MPT; MALE CON.(N)	\$2.92	\$2.73	\$2.53
SCV-4042NO	CV;1/4" JACO X 1/8" MPT; FIXED ELBOW (N)	\$3.12	\$2.91	\$2.71



Check Valve (Jaco) (SCV-___)

Stainless Steel Check Valve - Inserted into John Guest Fittings

Part #	Description	1±	25±	100±
SCV-CI010821W	CV;1/4"QC X 1/8" MPT; MALE CON.-WHITE	\$3.59	\$3.35	\$3.11
SCV-PI010821S	CV;1/4"QC X 1/8" MPT; MALE CON.-GREY	\$3.18	\$2.97	\$2.76
SCV-CI010822W	CV;1/4"QC X 1/4" MPT; MALE CON.-WHITE	\$3.88	\$3.62	\$3.36
SCV-CI011222W	CV;3/8"QC X 1/4" MPT; MALE CON.-WHITE	\$4.84	\$4.52	\$4.19
SCV-PI480821S	CV;1/4"QC X 1/8" MPT; FIXED ELBOW-GREY	\$4.06	\$3.79	\$3.52
SCV-PI480822S	CV;1/4"QC X 1/4" MPT; FIXED ELBOW-GREY	\$4.63	\$4.32	\$4.01
SCV-CI050821W	CV;1/4" STEM X 1/8" MPT; STEM ADPT.-WHITE	\$2.62	\$2.45	\$2.27
SCV-PI050821S	CV;1/4" STEM X 1/8" MPT; STEM ADPT.-GREY	\$2.64	\$2.46	\$2.29
SCV-CI480821W	CV;1/4"QC X 1/8" MPT; FIXED ELBOW-WHITE	\$4.42	\$4.12	\$3.83



Check Valve (JG) (SCV-___)



JOHN GUEST® CHECK VALVES



John Guest® Inline Check Valves are designed with Super Speedfit technology, featuring the same simplicity as JG fittings providing a fast & secure way of connecting plastic tubing without the use of tools. The valves can be mounted in any position; the arrow indicates the direction of flow.



Inline Check Valves

Check Valves - Inline

Part #	Description	1±	100±	200±	500±
1/4SCV	1/4" JG	\$10.59	\$8.83	\$7.95	\$7.06
Part #	Description	1±	100±	500±	1000±
5/16SCV	5/16" JG	\$10.60	\$8.83	\$7.95	\$7.07
Part #	Description	1±	80±	400±	800±
3/8SCV	3/8" JG	\$10.84	\$9.04	\$8.13	\$7.23
Part #	Description	1±	100±	200±	500±
1/2SCV	1/2" JG	\$11.43	\$9.52	\$8.57	\$7.62

SMC® CHECK VALVES



SMC® Provides competitively priced high quality check valves for positive checking. To prevent potential leaks and quality control is maintained from start to finish.

PVC NSF Check Valves (426 Series)

Part #	Description	1±	10±	150±
5720990	1/8" FPT X 1/8" FPT - BUNA	\$8.95	\$8.35	\$7.76
5722390	1/8" FPT X 1/8" FPT - VITON	\$8.81	\$8.23	\$7.64
5721090	1/4" FPT X 1/4" FPT - BUNA	\$8.52	\$7.95	\$7.38
5721290	1/4" FPT X 1/4" MPT - BUNA	\$8.34	\$7.79	\$7.23
5721590	1/2" BARB X 1/2" BARB - BUNA	\$8.95	\$8.35	\$7.76
5720690	1/4" FPT X 1/4" FPT - VITON	\$8.52	\$7.95	\$7.38
5721190	1/4" MPT X 1/4" MPT - BUNA	\$8.95	\$8.35	\$7.76

FP (Filled Polypropylene) NSF Check Valves

Part #	Description	1±	10±	150±
6850090	685 SERIES;1/2" F X 1/2" F - BUNA	\$8.69	\$8.12	\$7.54
6870090	687 SERIES;3/4" F X 3/4" F - BUNA	\$9.89	\$9.23	\$8.57
6940090	694 SERIES;1/4" F X 1/4" F - BUNA	\$7.92	\$7.39	\$6.86

Fittings / Components



PVC NSF Check Valve
426 Series



Filled Polypropylene
Check Valve
694 Series

JACO® CHECK VALVES



KYNAR Check Valves

Part #	Description	1±	25±	125±	250±
CV-2-K	1/8"	\$10.06	\$8.05	\$7.38	\$6.71
CV-4-K	1/4"	\$10.71	\$8.57	\$7.85	\$7.14
CV-6-K	3/8"	\$11.41	\$9.13	\$8.37	\$7.61
CV-8-K-EP	1/2" EP O-RING	\$12.88	\$10.31	\$9.45	\$8.59
Part #	Description	1±	10±	25±	50±
CV-8-K	1/2"	\$12.88	\$10.30	\$9.44	\$8.59



KYNAR Check Valve



PENTAIR® FILTER HOUSING WRENCHES, O-RINGS AND BRACKETS



PENTEK



(244043)

Filter Wrenches - Pentek Products (Previously Ametek & US Water)

Part #	Description	CASE			
		1±	50±	250±	500±
150539	SW-1A SPANNER WRENCH; SLIM LINE	\$5.03	\$4.25	\$3.90	\$3.54
150295	SW-2 SPANNER WRENCH; 3/4" HOUSING	\$4.99	\$4.22	\$3.87	\$3.51
150296	SW-3 SPANNER WRENCH; 10" BB	\$5.28	\$4.46	\$4.09	\$3.72
144368	SW-4 SPANNER WRENCH, 20" BB	\$5.28	\$4.46	\$4.09	\$3.72
144880	BW-FHWR; S.WRENCH FOR BW & BC	\$7.14	\$6.03	\$5.53	\$5.03

Filter Housing O-Rings - Pentek (Previously Ametek)

Part #	Description	CASE			
		1±	10±	50±	100±
151121	1/4" & 3/8" & 1/2" Inlet Filter Housing O-Rings	\$3.18	\$2.69	\$2.46	\$2.24
151120	3/4" inlet Filter Housing O-Rings - Pentek	\$2.63	\$2.22	\$2.04	\$1.85
151122	Big blue Filter Housing O-Rings - Pentek	\$8.28	\$7.00	\$6.42	\$6.07

Slimline Housing Brackets [1/4" 3/8" & 1/2" Ports]

Part #	Description	CASE			
		1±	10±	50±	100±
244047	SL-ZP BRACKET KIT [L]	\$6.71	\$5.67	\$5.20	\$4.73

Standard Housing Brackets [3/4" Ports]

Part #	Description	CASE			
		1±	10±	50±	100±
150578	MC-1A BRACKET KIT [L]	\$9.27	\$7.83	\$7.18	\$6.53
151011	UB-1 VIH BRACKET KIT [U]	\$10.67	\$9.02	\$8.27	\$7.51

Single - Big Blue, Big White, Big Clear Housing Brackets

Part #	Description	CASE			
		1±	5±	25±	50±
357640	WB-SS KIT S.S. [L]	\$66.19	\$55.94	\$51.28	\$46.61

Double - Big Blue, Big White, Big Clear Housing Brackets

Part #	Description	CASE			
		1±	5±	25±	50±
144258	TWO HOUSING BIG BLUE	\$74.58	\$63.03	\$57.78	\$52.52

Triple - Big Blue, Big White, Big Clear Housing Brackets

Part #	Description	CASE			
		1±	5±	25±	50±
144259	THREE HOUSING BIG BLUE	\$127.73	\$107.94	\$98.94	\$89.95



(144258)

(144259)

Fittings / Components

BRACKETS



BB Bracket L Style
(BB-L-1020)



Two Housing Bracket

Big Blue Single Brackets

Part #	Description	1±	25±	50±
		BB-L-1020	BB BRACKET L STYLE	\$11.33

Big Blue Screws [Lag Bolts]

Part #	Description	1±	100±	250±
		251031L0100SS	STAINLESS 5/16" X 1" LAG BOLT (QTY 4 required)	\$0.47

Two Housing Brackets

Part #	Description	1±	10±	25±
		A-FM30B	2 STAGE; 9 1/4" X 5 1/4"; Z STYLE	\$19.05
A-FM30W	2 STAGE; 9 1/4" X 5 1/4"; Z STYLE	\$14.33	\$13.38	\$12.42
A-2BB	2 STAGE BB; 5 1/4" X 8"; Z STYLE	\$36.30	\$33.88	\$31.46



Three Housing Bracket

Three Housing Brackets

Part #	Description	1±	10±	25±
A-FM50B	3 STAGE; BLACK; Z-STYLE	\$15.08	\$14.07	\$13.07
A-FM60B	3 STAGE; 14 1/8" X 5 3/4"; U STYLE	\$16.06	\$14.99	\$13.92
A-FM60W	3 STAGE; 14 1/8" X 5 3/4"; U STYLE	\$17.23	\$16.08	\$14.94
A-FM100B	3 STAGE; 13 1/4" X 5 1/4"; U STYLE	\$10.40	\$9.70	\$9.01



(Q-BRACKET)

Q-Series Brackets

Part #	Description	1±	10±	50±
Q-BRACKET	SINGLE Q-SERIES BRACKET; L	\$2.48	\$2.26	\$2.02
Part #	Description	1±	10±	25±
A-A-BVG2	2 STAGE; 7 1/4" X 3"; Z STYLE	\$6.97	\$6.50	\$6.04
A-BVG3	3 STAGE; 10 1/2" X 3"; Z STYLE; ELEC.P	\$10.44	\$9.75	\$9.05
A-BV4	4 STAGE; 11" X 4 1/8"; U STYLE	\$12.88	\$12.03	\$11.17
A-BVG2	2 STAGE; 7 1/4" X 3"; Z STYLE; ELEC.P	\$11.36	\$10.60	\$9.84
A-BV3	3 STAGE; 11" X 4 1/8"; U STYLE	\$12.01	\$11.21	\$10.41

RO-Pump Mounting Brackets

Part #	Description	1±	10±	25±
A-BV4-P	4 STAGE Q-SERIES; 11" X 4 1/4" X 3"; Z STYLE	\$31.64	\$29.53	\$27.42
A-HR35B	3 STAGE W/STEP; 12" X 3 1/4" X 4 1/2"; Z	\$17.46	\$16.30	\$15.14
A-HR35W	3 STAGE W/STEP; 12" X 3 1/4" X 4 1/2"; Z	\$28.49	\$26.59	\$24.69

CLIPS



Base Clip
(PPC212W)



Base Clip
(PPC202W)



Base Clip
(PPC204W)



Double Clip
(PPC208W)



Double Clip
(PPC205W)

Base Clips

Part #	Description	1±	50±	300±	600±
PPC204B	2" BASE CLIP - BLACK	\$0.63	\$0.59	\$0.55	\$0.51
PPC204W	2" BASE CLIP-WHITE	\$0.67	\$0.63	\$0.58	\$0.54

Part #	Description	1±	50±	250±	500±
PPC212B	2.5" BASE CLIP; EASY - BLACK	\$0.63	\$0.59	\$0.55	\$0.51
PPC212W	2.5" BASE CLIP; EASY - WHITE	\$0.67	\$0.63	\$0.58	\$0.54

Part #	Description	1±	50±	200±	400±
PPC202B	2.5" BASE CLIP; EXTRA STRONG - BLACK	\$0.63	\$0.59	\$0.55	\$0.51
PPC202W	2.5" BASE CLIP; EXTRA STRONG - WHITE	\$0.67	\$0.63	\$0.58	\$0.54

Double Clips

Part #	Description	1±	50±	300±	600±
PPC208B	2" X 2" DOUBLE - BLACK	\$0.63	\$0.59	\$0.55	\$0.51
PPC208W	2" X 2" DOUBLE - WHITE	\$0.63	\$0.59	\$0.55	\$0.51

Part #	Description	1±	50±	250±	500±
PPC205B	2.5" X 2" DOUBLE - BLACK	\$0.63	\$0.59	\$0.55	\$0.51
PPC205W	2.5" X 2" DOUBLE - WHITE	\$0.67	\$0.63	\$0.58	\$0.54

Part #	Description	1±	50±	200±	400±
PPC222B	2.5" X 2.5" LARGE DOUBLE - BLACK	\$0.63	\$0.59	\$0.55	\$0.51
PPC222W	2.5" X 2.5" LARGE DOUBLE - WHITE	\$0.63	\$0.59	\$0.55	\$0.51



NOTES

Notes section with horizontal lines for writing.

Fittings / Components



R.O. TANKS & ACCESSORIES



RO tanks



METAL REVERSE OSMOSIS TANKS



3.2 Gal NSF RO Tank
(TKE-3200W)

Tank Size Chart
On Next Page

2 Gallon RO Tank

Part #	Description	1+	10+	88+
TKE-1200W	PAE RO-120; 2 GAL 1/4" - WHITE	\$28.87	\$26.95	\$25.02

3 Gallon RO Tank

Part #	Description	1+	10+	100+
TKE-2200W	PAE RO-122; 3 GAL NSF - WHITE	\$29.44	\$27.47	\$25.51

4 Gallon RO Tanks

Part #	Description	1+	10+	88+
TKE-3200W	PAE RO-132; 4 GAL NSF - WHITE	\$29.22	\$27.27	\$25.33
TKE-3200B	PAE RO-132; 4 GAL NSF - BLUE	\$33.67	\$31.43	\$29.18

5.5 Gallon RO Tank

Part #	Description	1+	10+	88+
TKE-5200	RO-152; 5.5 GAL - WHITE	\$46.24	\$43.16	\$40.08

9.2 Gallon RO Tank

Part #	Description	1+	10+	36+
TKE-TP35	PAE 9.2 GAL 1/4" - WHITE	\$78.69	\$73.45	\$68.20

14 Gallon RO Tank

Part #	Description	1+	10+	27+
TKE-1070-W-1/4	PAE 14 GAL 1/4" NSF - WHITE	\$106.27	\$99.19	\$92.10
TKE-1070-W-3/4	PAE 14 GAL 3/4" NSF - WHITE	\$113.56	\$105.99	\$98.42

20 Gallon RO Tank

Part #	Description	1+	10+	18+
TKE-2000W	PAE RO-2000; 20 GAL 3/4" NSF - WHITE	\$169.55	\$158.25	\$146.95

28 Gallon NSF RO Tank

Part #	Description	1+	4+	18+	
TKE-2800W *	PAE RO-2800; 28 GAL 1" BSP - WHITE * TANK INCLUDES 3/8" BALL VALVE KIT	\$243.37	\$227.15	\$210.92	NOT IN LIST

PLASTIC REVERSE OSMOSIS TANKS



3.2 Gallon Plastic RO Tank
(TKE-2400-P)

3.2 Gallon RO Tank

Part #	Description	1+	10+	100+
TKE-2400-P	PAE TP-12P PLASTIC TANK; 3.2 GAL. WHITE	\$34.06	\$31.79	\$29.52

5 Gallon RO Tank

Part #	Description	1+	10+	80+
TKE-5000P	PAE TP-19P PLASTEEL TANK; 5 GAL. WHITE	\$42.19	\$39.38	\$36.56



REVERSE OSMOSIS TANKS SIZE CHART

PAE Metal Tanks

Part#	Factory Part#	Capacity (gallon)	Diameter	Height	Fitting	Wt. (Lbs)	Color	Qty of Pallet
TKE-1200	RO-120	2	8"	13"	1/4"	5.75	White	150
TKE-2200	RO-122	3.2	9"	14"	1/4"	7	White	100
TKE-3200	RO-132	4.4	11"	14"	1/4"	9	White Blue Black	88
TKE-5200	RO-152	5.5	12"	16"	1/4"	11	White	80
TKE-TP35	TP-35	9.2	13"	21"	1/4"	15.5	White	35
TKE-1070	RO-1070	14	16"	23"	1/4"	27	White	27
					3/4"		Blue	
TKE-2000	RO-2000	20	16"	30"	3/4"	37	White	18
					1"		Blue	
TKE-2800	RO-2800	28	16"	38"	1" BSP	47	White	N/A
					Blue			

PAE Plasteel Tanks

Part#	Factory Part#	Capacity (gallon)	Diameter	Height	Fitting	Wt. (Lbs)	Color	Qty of Pallet
TKE-2400P	TP-12P	3.2 Plastic	9"	14"	1/4"	4	White	100
TKE-5000P	TP-19P	5 Plastic	11.5"	16"	1/4"	11	White	80

RO tanks



AMTROL™ REVERSE OSMOSIS TANKS



Amtrol™ Tank Sizes

Part#	Diameter		Height		Gallon Capacity @ 50 PSI Feed Pressure
	cm	inches	cm	inches	
141S344	27.94	11"	38.1	15"	3.1
143-132	39.05	15 3/8"	44.13	17 3/8"	6.9
143-198	39.05	15 3/8"	56.36	22 3/16"	9.7
147-47	55.88	22"	74.93	29 1/2"	20.6
147-69	55.88	22"	91.44	36"	27.2
150-6	66.04	26"	119.86	47 3/16"	53.2



34 gal.
(147-47)



44 gal.
(147-69)



86 gal.
(150-6)

Standard Residential Tanks

Part #	Description	1+	10+	48+
141S344	RO-4W 4.4 GAL; W/S/BUMPS-WHITE-SS; 1/4"	\$93.83	\$87.58	\$81.32

Light Commercial Tanks

Part #	Description	1+	5+	10+
143-132	10B 10.3 GALLON - BLUE; 3/4" MIP	\$313.47	\$292.57	\$271.67
143-198	14B 14 GALLON - BLUE; 3/4" MIP	\$323.88	\$302.29	\$280.70
143-293	14B 14 GALLON - BLUE; 1/4" MIP	\$294.78	\$275.12	\$255.47
144-120	20B 20 GALLON - BLUE; 1" MIP	\$415.42	\$387.72	\$360.03

Tank Shut Off Kits

Part #	Description	1+	10+	
BVK-143-198	BALL VALVE KIT; 3/4" FIP X 1/4" JACO	\$12.72	\$11.93	
BVK-143-198(JG)	BALL VALVE KIT; 3/4" FIP X 1/4" JG	\$4.54	\$4.18	
BVK-143-198-3/8	BALL VALVE KIT; 3/4" FIP X 3/8" JACO	\$6.02	\$5.54	
BVK-143198JG3/8	BALL VALVE KIT; 3/4" FIP X 3/8" JG	\$10.18	\$9.36	
AK-144-120	PVC 1" ADAPTER KIT; 1/4" TUBE	\$22.18	\$20.39	
AK-144-120(3/8)	PVC 1" ADAPTER KIT; 3/8" TUBE	\$23.56	\$21.66	
AK-147-47	PVC 1-1/4" ADAPTER KIT; 1/4" TUBE	\$23.65	\$21.74	
AK-147-47(3/8)	PVC 1-1/4" ADAPTER KIT; 3/8" TUBE	\$24.75	\$22.75	
AK-147-69	PVC 1-1/4" ADAPTER KIT; 1/4" TUBE	\$23.66	\$21.75	
AK-150-6	PVC 1 1/4" ADAPTER KIT; 1/4" TUBE	\$20.06	\$18.44	
Part #	Description	1+	10+	50+
141-950	TANK STAND - BLACK PLASTIC	\$3.93	\$3.67	\$3.41

Tank Ball Valves
on pages (108, 114, 123)

RO Tanks



STRUCTURAL™ ROmate™ TANKS



STRUCTURAL
Pentair Water



ROmate™ Vessels

Part #	Description	1±	2±	4±	8±
RO-20	RO-MATE 20; 19.8 GALLON; 1" MPT	\$524.70	\$449.75	\$427.26	\$412.27
RO-40	RO-MATE 40; 40.3 GALLON; 1" MPT	\$720.51	\$617.58	\$586.71	\$566.12
RO-80	RO-MATE 80; 86.7 GALLON; 1 1/4" MPT	\$1,231.58	\$1,055.64	\$1,002.86	\$967.67
RO-120	RO-MATE 120; 119.7 GALLON; 1 1/4" MPT	\$1,502.44	\$1,287.80	\$1,223.41	\$1,180.49

SPECIFICATIONS AND PERFORMANCE

PART#	MODEL#	CAPACITY	MAX. OPERATING PRESSURE	DIMENSIONS	HEIGHT OF INLET / OUTLET TO FLOOR	SYSTEM CONNECTION
CH30839	RO20	19.8 gal (75 L)	125 psi, 862 kPa, 8.6 bar	16 x 32" (41 x 81 cm)	1¾" (4.4 cm)	1" MNPT
CH30865	RO40	40.3 gal (153 L)	125 psi, 862 kPa, 8.6 bar	16 x 57" (41 x 145 cm)	1¾" (4.4 cm)	1" MNPT
CH31054	RO80	86.7 gal (328 L)	125 psi, 862 kPa, 8.6 bar	24 x 55¼" (61 x 104 cm)	2½" (5.7 cm)	1½" MNPT
CH34395	RO120	119.7 gal (453 L)	125 psi, 862 kPa, 8.6 bar	24 x 74¼" (61 x 189 cm)	2½" (5.7 cm)	1½" MNPT

TANK PRESSURE GAUGES

Tank Low Pressure Gauges

Part #	Description	1±	10±	25±
54846	PRESSURE GAUGE (0-20 PSI)	\$12.82	\$11.97	\$11.11
Part #	Description	1±	6±	30±
TPG-100	DIGITAL TANK PRESSURE GAUGE (PSI)	\$16.86	\$15.74	\$14.61



(54846)



(TPG-100)

RO tanks



NOTES

Lined area for notes with a large 'GOOD' watermark in the center.

R.O Tanks



FAUCETS & ACCESSORIES



Faucets



QMP® FAUCETS



802 Ceramic Faucets

Part #	Description	1+	10+	50+	100+
QMP802-AG	CHROME; AG	\$35.65	\$33.33	\$31.95	\$29.63
QMP802	CHROME; NON-AG	\$30.81	\$28.81	\$27.61	\$25.61
QMP802-W	WHITE; NON-AG	\$42.97	\$40.18	\$38.51	\$35.72

804 Ceramic Faucets

Part #	Description	1+	10+	50+	100+
QMP804-BRNICKEL	BRUSHED NICKEL; NON-AG	\$43.88	\$41.03	\$39.33	\$36.48
QMP804	CHROME; NON-AG	\$33.45	\$31.28	\$29.98	\$27.81

102 Long Reach Airgap Faucets

Part #	Description	1+	10+	50+	100+
QMP102AG-C-AL	ALMOND	\$33.93	\$31.72	\$30.40	\$28.20
QMP102AG-C-B	BLACK	\$39.38	\$36.82	\$35.29	\$32.73
QMP102AG-C-BC	BRUSHED CHROME	\$37.50	\$35.07	\$33.61	\$31.17
QMP102AG	CHROME	\$29.51	\$27.59	\$26.45	\$24.53
QMP102AG-ORB	OIL RUBBED BRONZE	\$41.08	\$38.41	\$36.81	\$34.14
QMP102AG-C-W	WHITE	\$37.50	\$35.07	\$33.61	\$31.17

102 Long Reach Non-Airgap Faucets

Part #	Description	1+	10+	50+	100+
QMP102A	ALMOND	\$29.17	\$27.27	\$26.14	\$24.24
QMP102-ANTBRASS	ANTIQUÉ BRASS	\$33.50	\$31.33	\$30.02	\$27.85
QMP102BK	BLACK	\$36.17	\$33.82	\$32.41	\$30.06
QMP102-BRBRASS	BRUSHED BRASS	\$39.91	\$37.32	\$35.76	\$33.17
QMP102-BRCHROME	BRUSHED CHROME	\$36.17	\$33.82	\$32.41	\$30.06
QMP102-BRNICKLE	BRUSHED NICKLE	\$38.57	\$36.07	\$34.56	\$32.06
QMP102-BRSTAINLESS	BRUSHED STAINLESS	\$36.17	\$33.82	\$32.41	\$30.06
QMP102	CHROME	\$29.16	\$27.27	\$26.13	\$24.24
QMP102-COPPER	COPPER	\$30.66	\$28.67	\$27.48	\$25.49
QMP102D	DUAL; HOT/ COLD - CHROME	\$55.07	\$51.49	\$49.35	\$45.77
QMP102C-MB	MATTE BLACK	\$35.12	\$32.84	\$31.47	\$29.19
QMP102-ORB	OIL RUBBED BRONZE	\$32.82	\$30.69	\$29.41	\$27.28
QMP102-PLNICKLE	POLISHED NICKLE	\$37.24	\$34.82	\$33.37	\$30.95
QMP102R	RED	\$37.72	\$35.27	\$33.80	\$31.35
QMP102W	WHITE	\$34.83	\$32.57	\$31.21	\$28.95



QMP102



QMP2011

2011 Ceramic Faucets

Part #	Description	1+	10+	50+	100+
QMP2011AG-C	CHROME; AG	\$86.73	\$81.09	\$77.72	\$72.08
QMP2011-C	CHROME; NON-AG	\$47.85	\$44.74	\$42.88	\$39.77

Faucets

TOMLINSON® FAUCETS



Designer Hot Cold



Contemporary Hot Cold

Designer Hot / Cold Faucets

Part #	Description	1+	15+	75+
1020900	600PBR HC; ANTIQUE BRONZE	\$159.55	\$149.73	\$142.37
1020905	600PBR HC; BRUSHED STAINLESS	\$163.94	\$153.85	\$146.28
1022305	600PBR HC; POLISHED CHROME	\$187.86	\$176.30	\$167.63
1020899	600PBR HC; SATIN NICKEL	\$163.94	\$153.85	\$146.28

Contemporary Hot / Cold Faucets

Part #	Description	1+	15+	75+
1020907	600CBR HC; ANTIQUE BRONZE	\$175.07	\$164.29	\$156.21
1020912	600CBR HC; BRUSHED STAINLESS	\$223.80	\$210.03	\$199.70
1022118	600CBR HC; POLISHED CHROME	\$171.83	\$161.26	\$153.33
1020890	600CBR HC; SATIN NICKEL	\$223.80	\$210.03	\$199.70



Designer

Matte Black

Designer Faucets - (Has removable airgap device)

Part #	Description	1+	15+	75+
1019311	ANTIQUE BRONZE	\$112.35	\$105.44	\$100.25
1019307	BLACK	\$132.98	\$124.80	\$118.66
1019444	BRIGHT NICKEL	\$97.98	\$91.95	\$87.43
1020518	BRUSHED STAINLESS	\$125.82	\$118.08	\$112.27
1026577	MATTE BLACK	\$138.86	\$130.31	\$123.91
1019309	POLISHED BRASS	\$130.33	\$122.31	\$116.29
1019299	POLISHED CHROME	\$109.64	\$102.89	\$97.83
1025811	POLISHED NICKEL	\$125.82	\$118.08	\$112.27
1019301	SATIN NICKEL	\$125.82	\$118.08	\$112.27
1024293	VENETIAN BRONZE	\$145.97	\$136.99	\$130.25
1019303	WHITE	\$93.08	\$87.35	\$83.06



Contemporary

Contemporary Faucets - (Has removable airgap device)

Part #	Description	1+	15+	75+
1020897	BISCUIT	\$112.17	\$105.27	\$100.09
1020894	BLACK	\$155.98	\$146.38	\$139.18
1020892	BRIGHT NICKEL	\$159.99	\$150.15	\$142.76
1020896	BRUSHED STAINLESS	\$143.81	\$134.96	\$128.33
1020587	CHROME	\$136.63	\$128.22	\$121.91
1026576	MATTE BLACK	\$156.33	\$146.71	\$139.49
1025810	POLISHED NICKEL	\$159.99	\$150.15	\$142.76
1020889	SATIN NICKEL	\$143.81	\$134.96	\$128.33
1024294	VENETIAN BRONZE	\$118.27	\$110.99	\$105.54
1020893	WHITE	\$112.16	\$105.26	\$100.08
1027069	BRUSHED GOLD	\$154.41	\$144.91	\$137.78



Vintage

Vintage Faucets - (Has removable airgap device)

Part #	Description	1+	15+	75+
1024801	ANTIQUE BRONZE	\$143.47	\$134.64	\$128.02
1024798	BRUSHED STAINLESS	\$143.47	\$134.64	\$128.02
1024763	POLISHED CHROME	\$165.38	\$155.20	\$147.57
1024774	VENETIAN BRONZE	\$143.47	\$134.64	\$128.02



Quadra

Quadra Faucets - (Has removable airgap device)

Part #	Description	1+	15+	75+
1025105	ANTIQUE BRONZE	\$200.60	\$188.26	\$179.00
1025104	BRUSHED STAINLESS	\$200.60	\$188.26	\$179.00
1024845	POLISHED CHROME	\$164.67	\$154.54	\$146.94
1025101	SATIN NICKEL	\$200.61	\$188.26	\$179.00
1025102	VENETIAN BRONZE	\$200.60	\$188.26	\$179.00



Ultra Contemporary

Ultra Contemporary Faucets - (Has removable airgap device)

Part #	Description	1+	15+	75+
1025115	ANTIQUE BRONZE	\$151.36	\$142.05	\$135.06
1025114	BRUSHED STAINLESS	\$151.36	\$142.05	\$135.06
1024852	POLISHED CHROME	\$115.47	\$108.37	\$103.04
1025112	VENETIAN BRONZE	\$155.53	\$145.96	\$138.78



VS603 VS713 VS888

Value Series RO Faucets - (AirGap also available, call for details)

Part #	Description	1+	15+	75+
1022280	VS603 - POLISHED CHROME	\$49.29	\$46.26	\$43.98
1022282	VS603 - SATIN NICKEL	\$50.01	\$46.93	\$44.62
1022298	VS713 - POLISHED CHROME	\$48.61	\$45.62	\$43.37
1022300	VS713 - SATIN NICKEL	\$57.76	\$54.21	\$51.54
1022286	VS888 - POLISHED CHROME	\$70.54	\$66.20	\$62.95
1022288	VS888 - SATIN NICKEL	\$80.51	\$75.56	\$71.84
1022387	VS802 - POLISHED CHROME	\$43.43	\$40.76	\$38.76
1022292	VS905 - POLISHED CHROME	\$108.17	\$101.51	\$96.52
1022294	VS905 - SATIN NICKEL	\$108.17	\$101.51	\$96.52
1024998	VS143 - POLISHED CHROME	\$81.53	\$76.52	\$72.75



VS802 VS905 VS143

Faucets



GOOD WATER WAREHOUSE FAUCETS



133 Series

Part #	Description	1+	10+	50+
FLR-133PSBN	133 FAUCET CV; BRUSHED NICKEL	\$27.83	\$25.97	\$24.12
FLR-133PSCP	133 FAUCET CV; CHROME	\$26.92	\$25.13	\$23.33

300 Series

Part #	Description	1+	10+	50+
FLR-300CP-UP	300 FAUCET LR; CHROME	\$17.84	\$16.65	\$15.46



522 Series

Part #	Description	1+	10+	50+
FLR-522PSORB	522 FAUCET; CV; OIL RUB BRONZE	\$33.32	\$31.09	\$28.87
FLR-522PSBN-AG	522 AG FAUCET; CV; BRUSHED NICKEL	\$35.05	\$32.71	\$30.38
FLR-522PSCP-AG	522 AG FAUCET; CV; CHROME	\$31.49	\$29.39	\$27.29



575 Series

Part #	Description	1+	10+	50+
FLR-575CP	575 FAUCET; CV; CHROME	\$25.01	\$23.34	\$21.67
FLR-575BN	575 FAUCET; CV; BRUSHED NICKEL	\$28.30	\$26.41	\$24.53
FLR-575MB	575 FAUCET; CV; MATTE BLACK	\$33.32	\$31.09	\$28.87



878 Series

Part #	Description	1+	20+	40+
FLR-878CP	878 FAUCET CHROME	\$23.01	\$21.48	\$19.94
FLR-878BN	878 FAUCET BRUSHED NICKEL	\$25.56	\$23.86	\$22.16
FLR-878MB	878 FAUCET MATT BLACK	\$28.20	\$26.32	\$24.44



978 Series

Part #	Description	1+	18+	36+
FLR-978CP	CERAMIC DSIC/PLASTIC VALVE; CHROME	\$33.24	\$31.02	\$28.81
FLR-978BN	CERAMIC DISC/PLASTIC VALVE; BRUSHED NICKEL	\$38.43	\$35.87	\$33.30

Faucet Wrench

Part #	Description	1+	5+	25+
270972	FAUCET WRENCH	\$9.12	\$8.52	\$7.91



Part #	Description	1+	10+	50+
QMP100-EXT	3" FAUCET STUD EXTENSION	\$9.67	\$9.04	\$8.66

Faucets



EMD FAUCETS



**EMD
Global**



Long Reach Faucets - Ceramic Valves

<u>Part #</u>	<u>Description</u>	<u>1+</u>	<u>10+</u>	<u>50+</u>	<u>100+</u>
EF-9-CC-BN	BRUSHED NICKEL, F9LF	\$48.04	\$44.35	\$41.27	\$40.04
EF-9-CC-C	CHROME, F9LF	\$44.04	\$40.65	\$37.83	\$36.70
EF-9-CC-BC	BRUSHED CHROME, PROP. 65 NSF	\$47.52	\$43.87	\$40.82	\$39.60
EF-9-CC-AL	ALMOND, PROP. 65 NSF	\$49.43	\$45.63	\$42.46	\$41.19
EF-9-CC-WH	WHITE, PROP. 65 NSF	\$49.44	\$45.64	\$42.47	\$41.20
EF-9-CC-BLK	BLACK, PROP. 65 NSF	\$49.44	\$45.64	\$42.47	\$41.20
EF-9-CC-ORB	OIL RUBBED BRONZE, F9LF	\$50.50	\$46.92	\$44.64	\$42.68

Faucets



NOTES

Lined area for notes with a large 'GOOD' watermark in the center.



INSTALLATION SUPPLIES

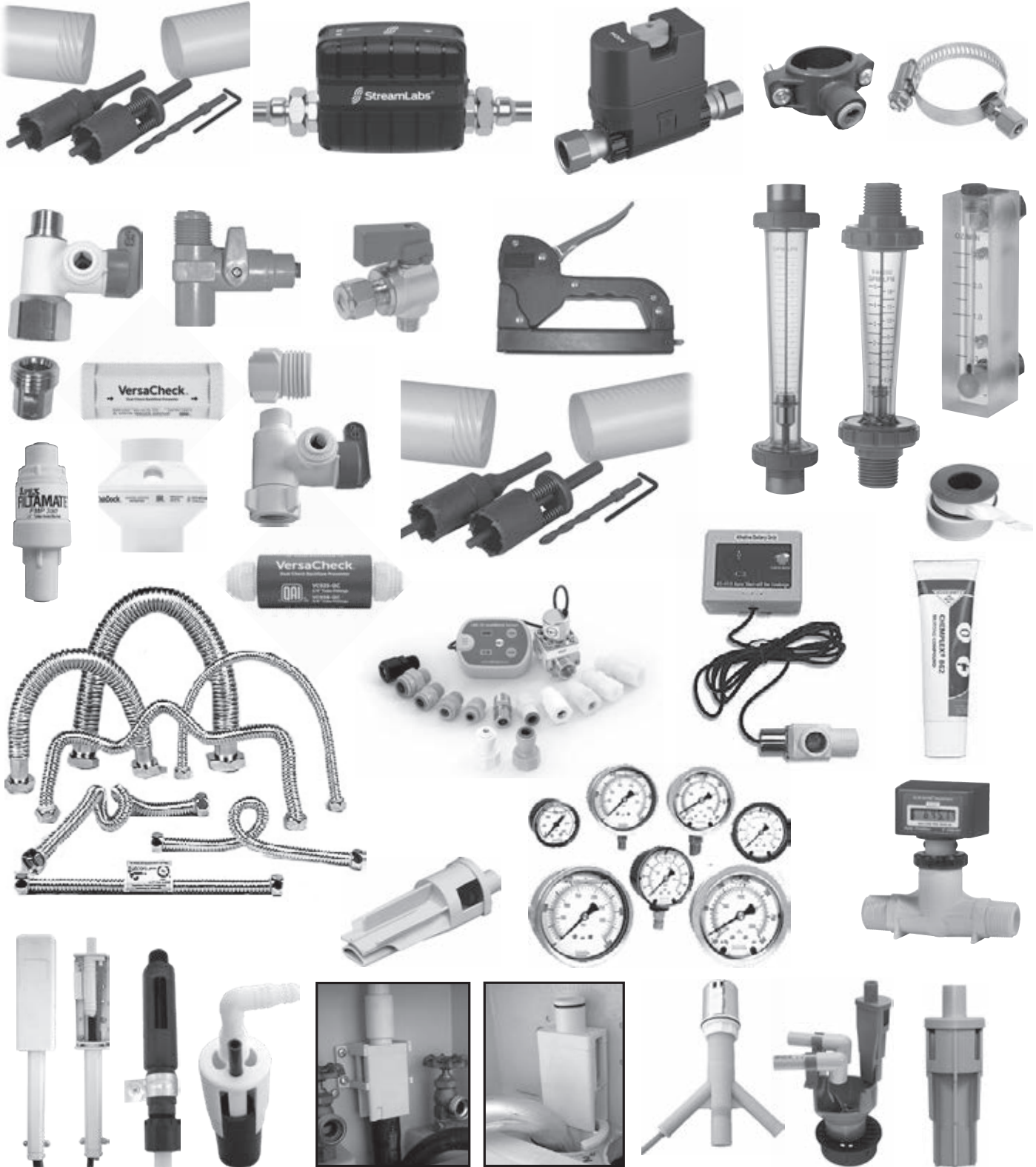

Installation Supplies



FEED VALVES



Max Adaptor

Max-Adapters (No Valve) - Brass - Lead Free

Part #	Description	1+	10+	25+
65-2000NL	3/8" C. X 3/8" C. X 1/4" C. ADAPTER	\$7.65	\$7.14	\$6.63
65-3000NL	3/8" C. X 3/8" C. X 1/4" FIP ADAPTER	\$10.65	\$9.94	\$9.23
65-2001NL	3/8" C. X 3/8" C. X 3/8" C. ADAPTER	\$7.65	\$7.14	\$6.63
65-2002NL	1/2" C. X 1/2" C. X 1/4" C. ADAPTER	\$9.53	\$8.89	\$8.26



John Guest®
Metal Angle Stop Adaptor Valve
(ASVPP5LF)



John Guest Metal Angle Stop Adapter Valves - Lead Free

Part #	Description	1+	30+	150+	300+
ASVPP1LF	JG 3/8" MALE X 3/8" FEMALE X 1/4" JG	\$12.11	\$10.50	\$9.49	\$8.89
ASVPP2LF	JG 3/8" MALE X 3/8" FEMALE X 3/8" JG	\$12.57	\$10.89	\$9.84	\$8.80
ASVPP5LF	JG 1/2Fx3/8M x 1/4JG Angle Stop Adapter	\$19.66	\$17.04	\$15.40	\$13.76



John Guest®
Plastic Angle Stop Adaptor Valve
(PASVPP5)



Part #	Description	1+	20+	100+	200+
ASVPP6LF	JG 1/2Fx3/8M x 3/8JG Angle Stop Adapter	\$20.76	\$17.99	\$16.26	\$14.53

John Guest Plastic Angle Stop Adapter Valves

Part #	Description	1+	25+	125+	250+
PASVPP1	3/8x3/8x1/4 ASV;PLASTIC	\$9.23	\$8.00	\$7.23	\$6.93
PASVPP2	3/8x3/8x3/8 ASV;PLASTIC	\$9.57	\$8.30	\$7.50	\$7.18
PASVPP5	3/8x3/8x1/4 ASV 1/2 ADPTR;PLASTIC	\$14.97	\$12.97	\$11.73	\$11.23
PASVPP6	3/8x3/8x3/8 ASV;1/2 ADPTR;PLASTIC	\$15.81	\$13.70	\$12.39	\$11.86



Easy Adaptor
(6893390)



Easy Adaptor
(6892390)

Easy Adaptors - PVC

Part #	Description	1+	10+	150+
6893390	1/2" FPT X 1/2" MPT W/1/4" JG (NO VALVE)	\$4.48	\$4.18	\$3.88
6893190	1/2" FPT X 1/2" MPT W/3/8" JG (NO VALVE)	\$4.35	\$4.06	\$3.77
6890590	1/2" FPT X 1/2" MPT X 1/4" FPT; NSF	\$8.56	\$7.99	\$7.42
6891190	1/2" FPT X 1/2" MPT X 1/4" JACO; NSF	\$9.12	\$8.51	\$7.90
6892390	1/2" FPT X 1/2" MPT X 1/4" JG; NSF	\$10.51	\$9.81	\$9.11

DRAIN CONNECTORS



Drain Connector
(PDC-Q14)

Drain Connectors

Part #	Description	1+	50+	100+	250+
PDC60438F	3/8" FPT	\$2.19	\$1.94	\$1.84	\$1.76
PDC-Q14	1/4" QUICK CONNECT	\$2.81	\$2.64	\$2.46	\$2.29

Part #	Description	1+	50+	125+	250+
PDC-Q38	3/8" QUICK CONNECT	\$3.18	\$2.98	\$2.78	\$2.58
PDC602F	1/4" FPT	\$2.81	\$2.64	\$2.46	\$2.29
PDC60438M	3/8" M. COMP.	\$2.65	\$2.49	\$2.32	\$2.15
PDC60414M	1/4" M. COMP.	\$2.81	\$2.64	\$2.46	\$2.29



Hose Clip
Drain Connector
(VV-DSI000)

Hose Clip Drain Connector

Part #	Description	1+	10+	50+
VV-DSI000	HOSE CLIP DRAIN TAP; 1/4" X 2.0 O.D.	\$6.77	\$6.32	\$5.87
VV-DSI000-38	HOSE CLIP DRAIN TAP; 3/8" X 2.0 O.D.	\$14.28	\$13.33	\$12.38



VISTA WATER GROUP AIRGAPS AND CHECK VALVES

VISTA WATER GROUP

VersaCheck - Dual Check Backflow Preventer



(VC100-P)



(VC150-A)



(VC025-QC)



DrainDock
(DD152)



DrainGap
(DH304-AG)



VIAGap
(VG050)

Part #	Description	1+	12+	60+
VC050-A	HIGH FLOW 1/2" FNPT; HARD COAT ALUMINUM	\$65.43	\$61.06	\$56.70
VC050-P	HIGH FLOW 1/2" FNPT :PVC	\$48.87	\$45.61	\$42.35
VC075-A	HIGH FLOW 3/4" FNPT; HARD COAT ALUMINUM	\$73.71	\$68.80	\$63.88
VC075-P	HIGH FLOW 3/4" FNPT; PVC	\$57.15	\$53.34	\$49.53
VC100-A	HIGH FLOW 1" FNPT; HARD COAT ALUMINUM	\$78.71	\$73.46	\$68.22
VC100-P	HIGH FLOW 1" FNPT; PVC	\$62.81	\$58.62	\$54.44
Part #	Description	1+	6+	30+
VC125-A	HIGH FLOW 1-1/4" FNPT; HARD COAT ALUMINUM	\$148.24	\$138.36	\$128.48
VC125-P	HIGH FLOW 1-1/4" FNPT; PVC	\$106.84	\$99.71	\$92.59
VC150-A	HIGH FLOW 1-1/2" FNPT; HARD COAT ALUMINUM	\$164.80	\$153.81	\$142.83
VC150-P	HIGH FLOW 1-1/2" FNPT; PVC	\$123.40	\$115.17	\$106.94
Part #	Description	1+	12+	60+
VCB025-A	BEVERAGE 1/4" FNPT; HARD COAT ALUMINUM	\$98.55	\$91.98	\$85.41
VCB025-P	BEVERAGE 1/4" FNPT; PVC	\$81.99	\$76.53	\$71.06
VCB038-A	BEVERAGE 3/8" FNPT; HARD COAT ALUMINUM	\$98.55	\$91.98	\$85.41
VCB038-P	BEVERAGE 3/8" FNPT; PVC	\$81.99	\$76.53	\$71.06
VC025-QC	QC (LOW FLOW) 1/4" TUBE QUICK CONNECT; PVC	\$40.58	\$37.88	\$35.17
VC038-QC	QC (LOW FLOW) 3/8" TUBE QUICK CONNECT; PVC	\$40.58	\$37.88	\$35.17

DrainDock - Multi-Port Drain Adapters

Part #	Description	1+	12+	60+
DD152	1/2" FNPT (2 INPUTS) 1.5" PIPE OR 2" COUPLING; PVC	\$32.31	\$30.15	\$28.00
DD154	1/2" FNPT (4 INPUTS) 1.5" PIPE OR 2" COUPLING; PVC	\$32.31	\$30.15	\$28.00
DD158	1/2" FNPT (8 INPUTS) 1.5" PIPE OR 2" COUPLING; PVC	\$32.31	\$30.15	\$28.00

DrainGap - Multi-Port Drain Adapters

Part #	Description	1+	12+	60+
DH154-AG	1/2" FNPT (4 INLETS) - 1.5" PIPE OR 2" COUPLING	\$40.58	\$37.88	\$35.17
DH304-AG	1/2" FNPT (4 INLETS) - 3" COUPLING; PVC	\$48.87	\$45.61	\$42.35
DH404-AG	1/2" FNPT (4 INLETS) - 4" COUPLING; PVC	\$48.87	\$45.61	\$42.35

VIAGap - Vertical Inline Air Gap

Part #	Description	1+	12+	60+
VG025	VIAGap 1/4" X 3/8" BARB; PVC	\$24.02	\$22.42	\$20.82
VG038	VIAGap 3/8" X 1/2" BARB; PVC	\$32.31	\$30.15	\$28.00
VG050	VIAGap 1/2" X 3/4" BARB; PVC	\$40.58	\$37.88	\$35.17
VG075	VIAGap 3/4" X 1" BARB; PVC	\$48.87	\$45.61	\$42.35



AIRGAP DEVICES



Drain Line Adapters

Part #	Description	1±	10±	25±
12-25JG	1 1/2" X 1/4" QC RO DRAIN ADAPTER KIT	\$16.13	\$15.18	\$14.24
12-38JG	1 1/2" X 3/8" QC RO DRAIN ADAPTER KIT	\$19.08	\$17.96	\$16.84
12-50B	1 1/2" X 1/2" BARB DRAIN ADAPTER KIT	\$16.13	\$15.18	\$14.24
D-25JG	1/2" - 7/8" BARB X 1/4" QC RO DRAIN ADAPTER KIT	\$16.58	\$15.61	\$14.63
D-38JG	1/2" - 7/8" BARB X 3/8" QC RO DRAIN ADAPTER KIT	\$16.39	\$15.43	\$14.47
D-50JG	1/2" - 7/8" BARB X 1/2" QC DRAIN ADAPTER KIT	\$12.08	\$11.37	\$10.66
D-50B	1/2" - 7/8" BARB X 1/2" BARB DRAIN ADAPTER KIT	\$12.08	\$11.37	\$10.66
Part #	Description	1±	10±	50±
9-25JG	1 1/2" X 1/4" QC RO DRAIN ADAPTER KIT	\$18.32	\$17.24	\$16.17
9-38JG	1 1/2" X 3/8" QC RO DRAIN ADAPTER KIT	\$18.13	\$17.07	\$16.00
9-50B	1 1/2" X 1/2" BARB DRAIN ADAPTER KIT	\$12.59	\$11.85	\$11.11

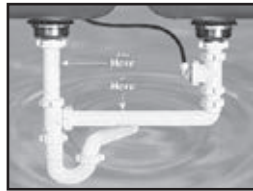

(12-38JG)

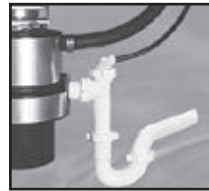

(9-38JG)



(D-38JG)



RO Air Gap
(T52-RO1)

Airgap Devices

Part #	Description	1±	10±	25±
TAG-NF	TWIN DISHWASHER AIRGAP 1/2" FPT (NO FITTING)	\$25.29	\$23.80	\$22.31
T52-RO1	SINGLE DISHWASHER AIRGAP KIT	\$63.68	\$59.93	\$56.19
TAG-58BI	TWIN DISHWASHER AIRGAP; CHROME; 5/8" BARB	\$25.29	\$23.80	\$22.31
TAG-NCNF	TWIN DISHWASHER AIRGAP 1/2" FPT (No Cover & Fitting)	\$18.86	\$17.75	\$16.64
31-S KIT S-C	GAP-A-RO 1/4" X 3/8" COOLER AIRGAP	\$32.18	\$30.29	\$28.39
211211	GAP-O-FLO INLINE AIRGAP 1/2" MIP X 3/4" MIP	\$26.41	\$24.86	\$23.31
8500	GAP-CAP	\$26.15	\$24.61	\$23.08
HF2	GAP-IT; 61-S; 1 1/2" STAND PIPE AIRGAP	\$24.30	\$22.87	\$21.44
HF1	GAP-IT; 61-S; 2" STAND PIPE AIRGAP	\$22.81	\$21.47	\$20.13
AG180-002	GAP-A DRAIN UNIVERSAL AIRGAP	\$44.87	\$42.24	\$39.60
34700	MR DRAIN SOFTENER AIRGAP	\$22.34	\$21.03	\$19.71



Gap-A-RO Kit
(31-S KIT S-C)



Gap-O-Flo
(211211)



Gap Cap
(8500)



Gap-It
(HF2)



Gap-It
(HF1)



Gap-A-Drain Universal
Drain Air Gap
(AG180-002)



Mr. Drain
(34700)

Part #	Description	1±	5±	25±
G-50JGP	1 1/2" X 1/2" QC DRAIN AIRGAP KIT	\$21.22	\$19.98	\$18.73
Part #	Description	1±	10±	25±
G-38JGP	1 1/2" X 3/8" QC RO DRAIN AIRGAP KIT	\$23.40	\$22.03	\$20.65
G-50BP	1 1/2" X 1/2" BARB DRAN AIRGAP KIT	\$23.93	\$22.52	\$21.11
G-150	1 1/2" HUB X 1/2" FPT; ABS AIRGAP	\$14.25	\$13.41	\$12.57
G-175	1 1/2" HUB X 3/4" FPT; ABS AIRGAP	\$14.25	\$13.41	\$12.57
G-200	2" HUB X 1" FPT; ABS AIRGAP	\$16.65	\$15.67	\$14.69



(G-50JGP)



(G-150)



(G-200)



FALCON® STAINLESS STEEL WATER FLEX CONNECTORS



A CSW Industrials Company



Female [FIP] X Male [MIP] Flex Connectors

Part #	Description	1+	25+	50+
FM-12"	3/4" FIP x 3/4" MIP; 3/4" ID SS FLEX CONN; 12"L	\$6.24	\$5.82	\$5.41
FM-15"	3/4" FIP x 3/4" MIP; 3/4" ID SS FLEX CONN; 15"L	\$7.32	\$6.83	\$6.34
FM-18"	3/4" FIP x 3/4" MIP; 3/4" ID SS FLEX CONN; 18"L	\$8.07	\$7.53	\$6.99
FM-24"	3/4" FIP x 3/4" MIP; 3/4" ID SS FLEX CONN; 24"L	\$9.25	\$8.63	\$8.02
FM1-18"	1" FIP x 1" MIP SS FLEX CONN; 18"L	\$24.01	\$22.41	\$20.81
FM1-24"	1" FIP x 1" MIP SS FLEX CONN; 24"L	\$28.41	\$26.52	\$24.62

Female [FIP] X Female [FIP] Flex Connectors

Part #	Description	1+	25+	50+
FF-12"	3/4" FIP x 3/4" FIP; 3/4" ID SS FLEX CONN; 12"L	\$6.38	\$5.96	\$5.53
FF-15"	3/4" FIP x 3/4" FIP; 3/4" ID SS FLEX CONN; 15"L	\$7.18	\$6.70	\$6.22
FF-24"	3/4" FIP x 3/4" FIP; 3/4" ID SS FLEX CONN; 24"L	\$8.80	\$8.21	\$7.63
S-02-12"	1/2" FIP SS COR WTRFLEX 12" L	\$4.39	\$4.09	\$3.80
S-02-16"	1/2" FIP SS COR WTRFLEX 16" L	\$5.26	\$4.91	\$4.56
S-02-20"	1/2" FIP SS COR WTRFLEX 20" L	\$6.13	\$5.73	\$5.32
S-02-30"	1/2" FIP SS COR WTRFLEX 30" L	\$8.13	\$7.59	\$7.05
SWC-1"X18"	1" FIP; 1" ID SS FLEX CONN; 18"L	\$22.85	\$21.32	\$19.80
SWCN134X18	1" FIP NYLON x 3/4" FIP x 18"L	\$9.04	\$8.44	\$7.84
SWC-1X34X18	1" FIP x 3/4" FIP; 3/4" ID SS FLEX CONN; 18"L	\$9.47	\$8.83	\$8.20
SWC-1X34X24	1" FIP x 3/4" FIP; 3/4" ID SS FLEX CONN; 24"L	\$10.57	\$9.87	\$9.16
SWCN-114X1X15	1 1/4" NYLON FIP x 1" FIP; 1":ID SS FLEX CONN; 15"L	\$17.49	\$16.33	\$15.16
FF-18"	3/4" FIP x 3/4" FIP; 3/4" ID SS FLEX CONN; 18"L	\$7.60	\$7.09	\$6.58
S-02-36"	1/2" FIP SS COR WTRFLEX 36" L	\$9.37	\$8.75	\$8.12
SWC-1"X12"	1" FIP; 1" ID SS FLEX CONN; 12"L	\$16.96	\$15.83	\$14.70
SWC-1"X24"	1" FIP; 1" ID SS FLEX CONN; 24"L	\$27.27	\$25.45	\$23.63
SWCN1141-12	1 1/4" NYLON FIP x 1" FIP x 12" L	\$19.83	\$18.51	\$17.19

Part #	Description	1+	25+	100+
SWCN-114X1X18	1 1/4" NYLON FIP x 1" FIP; 1":ID SS FLEX CONN; 18"L	\$25.48	\$24.08	\$22.34

Part #	Description	1+	25+	50+
SWC-114"X18"	1 1/4" FIP x 1 1/4" ID SS FLEX CONN; 18"L	\$34.52	\$32.22	\$29.91
SWC-114X24"	1 1/4" FIP x 1 1/4" ID SS FLEX CONN; 24"L	\$34.52	\$32.22	\$29.91
SWC-2"X18"	2" FIP x 2" ID SS FLEX CONN; 18"L	\$70.32	\$65.63	\$60.95
SWC-2"X24"	2" FIP x 2" ID SS FLEX CONN; 24"L	\$79.93	\$74.60	\$69.27
SWC-112X24"	1 1/2" FIP x 1 1/2" ID SS FLEX CONN; 24"L	\$51.35	\$47.93	\$44.51

Push To Connect [QC] Flex Connectors

Part #	Description	1+	25+	50+
PTC-PTC34-18	3/4" JG PTC x 3/4" JG PTC x 18" [3/4" ID.]	\$21.95	\$20.49	\$19.03
PTC34-JG18	3/4" FIP x 3/4" JG PTC; 18"	\$16.17	\$15.09	\$14.01
PTC34-JG24	3/4" JG PTC x 3/4" FPT x 24"	\$18.27	\$17.06	\$15.84
PTC1-JG1N-18	1" NYLON FIP x 1" JG PTC; 18"	\$32.37	\$30.21	\$28.05
PTC1-JG1N-24	1" JG PTC x 1" NYLON FIP; 24"	\$36.79	\$34.34	\$31.89
PTC34-JG18-114N	1 1/4" NYLON FIP x 3/4" JG PTC; 18"	\$20.71	\$19.33	\$17.95

Part #	Description	1+	25+	125+
PTC1-JG114N-18"	1 1/4" NYLON FIP x 1" JG PTC; 18"	\$30.29	\$28.63	\$26.56

Clack Water Flex Connectors

Part #	Description	1+	25+	50+
PTC34JG-CLKQC-18	3/4" JG PTC x CLK QC x 18"	\$20.13	\$18.79	\$17.44
CLK X34X18	CLACK QC x 3/4" FIP FLEX CONN x 18"L	\$14.20	\$13.25	\$12.30
CLK X 34X24	CLACK QC x 3/4" FIP FLEX CONN x 24"L	\$20.67	\$17.29	\$16.44
CLKQC-1FIP-18"	CLACK QC x 1" FIP FLEX CONN x 18"L	\$25.25	\$23.57	\$21.89
CLK QCXQCX18	CLACK QC x CLACK QC x 18"	\$27.80	\$25.95	\$24.09
PTC34JG-CLKQC-24	3/4" JG PTC x CLK QC x 24"	\$20.79	\$19.40	\$18.02
PTC1JG-CLKQC-18	1" JG PTC x CLK QC x 18"	\$29.76	\$27.78	\$25.79
PTC1JG-CLKQC-24	1" JG PTC x CLK QC x 24"	\$32.62	\$30.44	\$28.27
CLKQC-1FIP-24	CLACK QC x 1" FIP FLEX CONN x 24"L	\$31.95	\$29.82	\$27.69
CLK QCXQCX24	CLACK QC x CLACK QC x 24"	\$31.96	\$29.83	\$27.70

Installation Supplies



INSTALLATION SUPPLIES MISCELLANEOUS



Adhesive Tubing Clips

Part #	Description	1+	50+	100+
9777	ADHESIVE TUBING CLIP; 1/4"	\$0.45	\$0.42	\$0.39
9778	ADHESIVE TUBING CLIP; 3/8"	\$1.01	\$0.90	\$0.78



Teflon Tape & Liquid

Part #	Description	1+	25+	50+
15831	TEFLON PTFE TAPE 1/2" X 520" IMP PER ROLL	\$0.76	\$0.71	\$0.66



Silicone Grease

Part #	Description	1+	4+	8+
1014081	SILICONE GREASE 8 OZ	\$31.66	\$30.47	\$29.27

Clip Gun

Part #	Description	1+	5+	10+
RB-2	CLIP GUN; FOR 1/4" TUBING	\$67.79	\$63.28	\$58.76
RB-4	CLIP GUN; FOR 3/8" TUBING	\$74.85	\$69.86	\$64.87
RB-4-CLIPS	CLIPS; FOR 3/8" TUBING; 400 PER BOX;BLK	\$62.10	\$57.96	\$53.82
RB-5	CLIP GUN; FOR 1/2", 5/8", & 3/4" TUBING	\$70.86	\$66.13	\$61.41
RB-5-CLIPS-3/4	CLIPS; FOR 3/4" TUBING; 100 PER BOX;BLK	\$16.20	\$15.12	\$14.04
RB-5-CLIPS-1/2	CLIPS; FOR 1/2" TUBING; 100 PER BOX;BLK	\$16.55	\$15.45	\$14.34



Faucet Wrench

Part #	Description	1+	5+	25+
270972	FAUCET WRENCH (TOPWAY)	\$9.12	\$8.52	\$7.91

RELTON® SINK HOLE CUTTERS



RELTON CORPORATION



1 Carbide Pilot Drill Bit (PD-42)

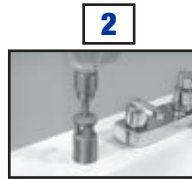

2 Spring-Loaded Porcelain Saw (P-14)



3 Finish Hole Saw (F-20)



Complete Cutter Kit (PC-20)

Porcelain Cutters

Part #	Description	1+	6+	11+
PC-14	7/8" CUTTER KIT COMPLETE	\$256.68	\$239.57	\$222.46
PC-16	1" CUTTER KIT COMPLETE	\$259.81	\$242.49	\$225.17
PC-20	1 1/4" CUTTER KIT COMPLETE	\$255.00	\$238.00	\$221.00

Porcelain Cutter Pilot Drill Bit

Part #	Description	1+	6+	11+
PD-42	CARBIDE PILOT DRILL BIT	\$15.90	\$14.84	\$13.78

Porcelain Cutter Components

Part #	Description	1+	6+	11+
P-14	7/8" PORCELAIN SAW COMPLETE	\$115.28	\$107.59	\$99.91
P-20	1 1/4" PORCELAIN SAW COMPLETE	\$129.48	\$120.85	\$112.22
F-14	7/8" FINISH HOLE SAW COMPLETE	\$97.68	\$91.17	\$84.66
F-16	1" FINISH HOLE SAW COMPLETE	\$96.54	\$90.11	\$83.67
F-20	1 1/4" FINISH HOLE SAW COMPLETE	\$93.33	\$87.11	\$80.89
F-14HO	7/8" FINISH HOLE SAW HEAD ONLY	\$66.16	\$61.75	\$57.34
F-16HO	1" FINISH HOLE SAW HEAD ONLY	\$67.58	\$63.07	\$58.57
F-20HO	1 1/4" FINISH HOLE SAW HEAD ONLY	\$78.84	\$73.58	\$68.33
S-12	7/8" SHANK - FINISH HOLE SAW	\$15.45	\$14.42	\$13.39
S-34	1" SHANK - FINISH HOLE SAW	\$22.72	\$21.20	\$19.69
GRT-14-6	7/8" SERRATED EDGE CARBIDE BIT	\$30.90	\$28.84	\$26.78
GRT-8-6	1/2" SERRATED EDGE CARBIDE BIT	\$13.84	\$12.92	\$11.99
GRT-7-6	7/16" MASONRY BIT	\$13.50	\$12.60	\$11.70



Multi-Purpose Drill Bit

Installation Supplies



BLUE-WHITE® FLOWMETERS



F-400N Flowmeters

F-400 Features:

- Injection molded, chemical resistant Polysulfone
- Quick Loc (1/2 union) adapters
- Available in configuration for in-line & panel mount installation
- Dual scale and single scale available
- Optional flow control needle metering valve

F - 400N Flowmeters

Part #	Description	1±	4±
F-40250LN-4	0.025 - 0.25 GPM; 1/4" FPT	\$137.25	\$132.40
F-40375LN-6	0.1 - 1 GPM; 3/8" FPT	\$137.25	\$132.40
F-40375LN-8	0.1 - 1 GPM; 1/2" FPT	\$137.25	\$132.40
F-40376LN-6	0.2 - 2 GPM; 3/8" FPT	\$137.25	\$132.40
F-40376LN-8	0.2 - 2 GPM; 1/2" FPT	\$137.25	\$132.40
F-40500LN-6	0.5 - 5 GPM; 3/8" FPT	\$137.25	\$132.40
F-40500LN-8	0.5 - 5 GPM; 1/2" FPT	\$137.25	\$132.40
F-40750LN-16	1.0 - 10 GPM; 1" FPT	\$275.55	\$265.82
F-41000LN-12	2.0 - 20 GPM; 3/4" FPT	\$275.55	\$265.82
F-41000LN-16	2.0 - 20 GPM; 1" FPT	\$275.55	\$265.82



F-440 Flowmeters

F-440 Features:

- Injection molded, chemical resistant Polysulfone
- Quick Loc (1/2 union) adapters
- Available in configuration for in-line & panel mount installation
- Dual scale and single scale available
- Optional flow control needle metering valve

F - 440 Flowmeters

Part #	Description	1±	4±
F-44375L-6	0.1-1 GPM, 3/8" MPT; FLOWMETER	\$137.25	\$132.40
F-44375L-8	.1-1 GPM 1/2" MPT	\$137.25	\$132.40
F-44375LA-8	.1-1 GPM; 1/2" MPT; FLOWMETER ADJ	\$243.64	\$235.04
F-44375LE-8	0.1-1 GPM; 1/2" ELB; FLOWMTR	\$158.53	\$152.93
F-44376LA-6	.2-2 GPM; 3/8" MPT; FLOWMETER ADJ	\$243.64	\$235.04
F-44376LA-8	.2-2 GPM; 1/2" MPT; FLOWMETER ADJ	\$243.64	\$235.04



F-450 Flowmeters

F-450 Features:

- Injection molded, chemical resistant Polysulfone
- Quick Loc (half union) adapters
- Units available in configurations for in-line and panel mount installation
- Optional flow control needle metering valve
- Dual scale and single scale available

F - 450 Flowmeters

Part #	Description	1±	4±
F-45375L-8	0.1-1GPM; 1/2" MPT; FLOWMETER	\$111.55	\$103.58
F-45500LHNE-8	0.5-5GPM; 1/2" MPT; PM FLOWMETER	\$127.60	\$118.49

Installation Supplies



F-451N High Volume

F-451 Features:

- Injection molded, chemical resistant Polysulfone
- Quick Loc (half union) adapters
- Units available in configurations for in-line and panel mount installation
- Adapters: Female NPT (national pipe thread)
- Dual scale and single scale available

F - 451N High Volume Flowmeters

Part #	Description	1+	4+
F-451006LHN	0.5 - 6 GPM; 1" FPT; IL	\$530.88	\$512.15
F-451001LHN	1.0 - 10 GPM; 1" FPT; IL	\$530.88	\$512.15
F-451001LHNE	1.0 - 10 GPM; 1" MPT; PM	\$530.88	\$512.15
F-451002LHN	2.0 - 20 GPM; 1" FPT; IL	\$530.88	\$512.15
F-451002LHNE	2.0 - 20 GPM; 1" MPT; PM	\$530.88	\$512.15
F-451003LHN	3.0 - 30 GPM; 1" FPT; IL	\$530.88	\$512.15
F-451003LHNE	3.0 - 30 GPM; 1" MPT; PM	\$530.88	\$512.15
F-451003LHN-24	3.0 - 30 GPM; 1.5" FPT; IL	\$530.88	\$512.15
F-451004LHN	4.0 - 40 GPM; 1" FPT; IL	\$530.88	\$512.15
F-451004LHNE	4.0 - 40 GPM; 1" MPT; PM	\$530.88	\$512.15
F-451004LHN-24	4.0 - 40 GPM; 1.5" FPT; IL	\$530.88	\$512.15



F-452 In-Line

F-452 Features:

- Injection molded, chemical resistant Polysulfone
- Quick Loc (half union) adapters
- Dual scale (GPM & LPM)
- Adapters: Female NPT (national pipe thread)
- Inline installation

F - 452 In - Line Flowmeters

Part #	Description	1+	4+
F-452080LHN	8-80GPM;2"FPT; FLOWMETER; SS	\$935.16	\$902.16
F-452130LHN	15-130GPM;2"FPT; FLOWMETER; SS	\$935.16	\$902.16
F-452175LHN	25-175GPM;2"FPT; FLOWMETER; SS	\$935.16	\$902.16



F-550 Panel Mount

F-550 Features:

- One piece machined and polished acrylic meter body
- Corrosion and wear resistant internal parts
- Adapters: Male NPT (national pipe thread)
- Panel mount installation
- Dual scale (GPM & LPM)

F - 550 Panel Mount Flowmeters

Part #	Description	1+	4+
F-55250L	0.025 - 0.25 GPM; 1/4" MPT	\$158.52	\$152.92
F-55375L	0.1 - 1 GPM; 3/8" MPT	\$158.52	\$152.92
F-55375LA	0.1 - 1 GPM; 3/8" MPT; ADJ. V.	\$232.99	\$224.77
F-55376L	0.2 - 2 GPM; 3/8" MPT	\$158.52	\$152.92
F-55376LA	0.2 - 2 GPM; 3/8" MPT; ADJ. V.	\$232.99	\$224.77
F-55500L	0.5 - 5 GPM; 1/2" MPT	\$158.52	\$152.92
F-55500LA	0.5 - 5 GPM; 1/2" MPT; ADJ. V.	\$232.99	\$224.77
F-55750L	1 - 10 GPM; 3/4" MPT	\$190.44	\$183.72
F-55200L	2 - 20 GPM; 1" MPT	\$254.27	\$245.29

F - 300 Flowmeters

Part #	Description	1+	4+
F-30100P	5-35 GPM; FLOWMETER, 1" PIPE	\$147.89	\$142.67
F-30150P	10-70 GPM; FLOWMETER, 1.5" PIPE	\$147.89	\$142.67
F-30200P	20-120 GPM; FLOWMETER, 2" PIPE	\$147.89	\$142.67
F-30600P	250 - 1050 GPM; 6" SADDLE	\$211.72	\$204.25



F-300 Flowmeters

Installation Supplies



F - 1000 Digital Inline Flowmeters (TB = Totalizer Only, RB = Flow Rate Only)

Part #	Description	1+	4+
RB-500MI-6GPM1	2 - 20 GPM RATE METER; 1/2" FPT	\$477.69	\$460.83
RTSB-20K8-GM1	30 - 300 GPM TOTALIZER; 2" SADDLE	\$988.35	\$953.47



F-1000 Digital Flowmeters

APEX® PRESSURE LIMITING VALVES



Apex Pressure Limiting Valve Features:

- Protects water filter units by limiting water pressure to inline cartridges & housings
- Reduces water hammer
- FMP 50 valves are designed for water filters, ice makers, coffee machines, etc...
- FMP 85 valves are suitable for R.O. water systems
- Acetyl body, complete with John Guest® speedfit connections, 1/4" tube



1/4" or 3/8" Filtamate Pressure Limiting Valves

1/4" Pressure Limiting Valves

Part #	Description	1+	25+	100+
FMP50PSI	50 PSI FILTAMATE 1/4" FQC	\$18.85	\$17.91	\$16.49
FMP60PSI	60 PSI FILTAMATE 1/4" FQC	\$18.85	\$17.91	\$16.49
FMP85PSI	85 PSI FILTAMATE 1/4" FQC	\$18.85	\$17.91	\$16.49

3/8" Pressure Limiting Valves

Part #	Description	1+	25+	100+
FMP50PSI-3/8	50 PSI FILTAMATE 3/8" FQC	\$23.77	\$22.58	\$20.80
FMP60PSI-3/8	60 PSI FILTAMATE 3/8" FQC	\$27.32	\$25.96	\$23.91
FMP85PSI-3/8	85 PSI FILTAMATE 3/8" FQC	\$27.32	\$25.96	\$23.91

Installation Supplies



LEAK DETECTORS



Leak Detector with Tray (LDT14)

Leak Detector with Tray - 1/4" Q.C.

- No batteries needed
- Larger detection area with tray design
- Convenient clamp secures drip tray to filter assembly
- Speedy cotton pad change



Leak Detector with Tray

Part #	Description	1+	5+	25+
LDT14	1/4" QC	\$18.15	\$17.37	\$16.85
LDT14-NT	1/4"QC; LEAK DETECTOR ONLY; NO TRAY	\$9.07	\$8.68	\$8.42
LDT14-3/8-NT	3/8"QC; LEAK DETECTOR ONLY; NO TRAY	\$9.07	\$8.68	\$8.42



Leak Block Sensor (LBS-10)

Unit comes with 3/8" FPT female thread ID allowing you to use any of the above pictured fittings

Leak Block Sensor

- 3/8" FPT or [1/2" Male BST] threaded ports
- Up to 5 gpm flow
- Low battery alert
- At end of battery life, solenoid latches closed as a failsafe

Leak Block Sensor

Part #	Description	1+	10+	40+
LBS-10	3/8" FPT [OR 1/2" MALE BST]	\$40.49	\$37.79	\$35.09



Leak Detector (LD-38-JG)

LD-38 Leak Detector

- Automatically Shut-off The Water Supply Before Disaster Occurs
- Low battery warning

LD-38 Leak Detector *

Part #	Description	1+	10+	50+
LD-38-JG	* LEAK DETECTOR	\$31.61	\$29.51	\$27.40

Fittings

Part #	Description	1+	200+	1000+
AFAB0407CW	1/4" QC X 1/2" BST FITTING	\$1.01	\$0.93	\$0.89
Part #	Description	1+	150+	750+
PI451214FS	3/8" QC X 1/2" BST FITTING	\$5.05	\$4.21	\$3.79

1/4" QC (AFAB0407CW)

3/8" QC (PI451214FS)



StreamLabs® Leak Protection

- Remote shut-off feature
- Inline water pressure, humidity, and temperature sensors
- Automatic monthly valve checks to ensure proper operation

The StreamLabs® Control features patented ultrasonic technology for real-time water monitoring, smart leak detection, and automatic shut-off to stop leaks in their tracks.

StreamLabs Leak Protection (No Fittings)

Part #	Description	1+	4+	24+
UFCV-1000	STREAMLABS CONTROL	\$963.52	\$921.01	\$850.17

StreamLabs Install Kits

Part #	Description	1+	4+	24+
UFAC-2001	3/4" SHARKBITE	\$51.49	\$49.22	\$45.43
UFAC-2002	1" SHARKBITE	\$51.49	\$49.22	\$45.43
UFAC-2011	3/4" FNPT	\$51.49	\$49.22	\$45.43
UFAC-2012	1" FNPT	\$51.49	\$49.22	\$45.43
UFAC-2013	1-1/4" FNPT	\$110.33	\$105.46	\$97.35



Installation Supplies



MOBILE APP



Smart Water Detector

FLO By MOEN Smart Water Monitor & Shut-off

- Proactive 24/7 monitoring with preventative alerts to avoid catastrophic damage.
- Mobile Application with real time notifications, water usage analysis, and goal setting features.
- Remote shut-off – with mobile application, user has the ability to shut-off water wherever they are.
- Automatic shut-off – if Flo senses a catastrophic leak in the home, it will automatically shut off the water supply to prevent damage.
- Microleak™ technology – daily tests to ensure your plumbing (not including sewage line) are secure.
- Configurable alert and notification preferences

Flo leak detecting device monitors pressure, temperature and flow of All the plumbing in your home 24/7. Learning and tailoring water security protection to your home. If a leak is detected the device will text, email or call you and automatically shut off the water to prevent damage.

FLO By MOEN Smart Water Monitor & Shut-off

Part #	Description	1±	4±	8±
900-001	3/4" FLO GEN 2 LEAK DETECTION	\$621.81	\$594.38	\$548.66
900-006	1" FLO GEN 2 LEAK DETECTION	\$724.52	\$692.56	\$639.29
900-002	1.25" FLO GEN 2 LEAK DETECTION	\$896.86	\$857.29	\$791.34

FLO By MOEN Smart Water Detector

- Low profile sensor allows water detection under any refrigerator or dishwasher
- Audibly alerts when senses a leak, high humidity and freezing temperatures
- Can be connected to FLO by MOEN whole house for automatic water shut off

FLO By MOEN Smart Water Detector

Part #	Description	1±	4±	8±
920-004	FLO SMART WATER DETECTOR [1 pack]	\$60.41	\$57.74	\$53.30
Part #	Description	1±	2±	4±
920-005	FLO SMART WATER DETECTOR [3 pack]	\$157.46	\$145.35	\$133.24

NOSHOK® GAUGES



900 Series Gauge

Available in following configurations:

- 15 TO 30,000 PSI
- 1.5" - 6" Diameter
- Bottom stem mount [BOT STEM]
- Center back mount [CB]
- PSI/kPa
- Dry or Liquid Filled
- Shatter resistant ABS
- Stainless steel with brass internals
- All stainless steel

Filled Gauges - Stainless Steel

Part #	Description	1±	10±	25±
25-901-30	2.5" SS; 1/4" BOTTOM STEM; 0-30PSI/KPA	\$28.47	\$26.91	\$24.96
25-901-60	2.5" SS; 1/4" BOTTOM STEM; 0-60PSI/KPA	\$31.31	\$29.59	\$27.45
25-901-100	2.5" SS; 1/4" BOTTOM STEM; 0-100PSI/KPA	\$30.65	\$28.97	\$26.87
25-901-160	2.5" SS; 1/4" BOTTOM STEM; 0-160PSI/KPA	\$31.57	\$29.84	\$27.68
25-901-200	2.5" SS; 1/4" BOTTOM STEM; 0-200PSI/KPA	\$35.00	\$33.09	\$30.69
25-901-300	2.5" SS; 1/4" BOTTOM STEM; 0-300PSI/KPA	\$31.31	\$29.59	\$27.45
25-901-400	2.5" SS; 1/4" BOTTOM STEM; 0-400PSI/KPA	\$28.47	\$26.91	\$24.96
25-901-600	2.5" SS; 1/4" BOTTOM STEM; 0-600PSI/KPA	\$31.31	\$29.59	\$27.45
25-901-1000	2.5" SS; 1/4" BOTTOM STEM; 0-1000PSI/KPA	\$25.89	\$24.47	\$22.70
25-901-1500	2.5" SS; 1/4" BOTTOM STEM; 0-1500PSI/KPA	\$29.72	\$28.09	\$26.06
25-901-2000	2.5" SS; 1/4" BOTTOM STEM; 0-2000PSI/KPA	\$33.71	\$31.86	\$29.56
25-901-3000	2.5" SS; 1/4" BOTTOM STEM; 0-3000PSI/KPA	\$23.00	\$21.74	\$20.17
25-901-5000	2.5" SS; 1/4" BOTTOM STEM; 0-5000PSI/KPA	\$33.70	\$31.86	\$29.55
25-911-030	2.5" SS; 1/4" CENTER BACK; 0-30PSI/KPA	\$32.80	\$31.00	\$28.76
25-911-060	2.5" SS; 1/4" CENTER BACK; 0-60PSI/KPA	\$33.79	\$31.94	\$29.62
25-911-100	2.5" SS; 1/4" CENTER BACK; 0-100PSI/KPA	\$32.92	\$31.12	\$28.86
25-911-160	2.5" SS; 1/4" CENTER BACK; 0-160PSI/KPA	\$32.92	\$31.12	\$28.86
25-911-200	2.5" SS; 1/4" CENTER BACK; 0-200PSI/KPA	\$32.94	\$31.13	\$28.88
25-911-300	2.5" SS; 1/4" CENTER BACK; 0-300PSI/KPA	\$32.80	\$31.00	\$28.76
25-911-400	2.5" SS; 1/4" CENTER BACK; 0-400PSI/KPA	\$33.79	\$31.94	\$29.62
25-911-600	2.5" SS; 1/4" CENTER BACK; 0-600PSI/KPA	\$29.69	\$28.06	\$26.03



Liquid Filled Gauges
Stainless Steel

Liquid Filled Gauges - All Stainless Steel

Part #	Description	1+	10+	25+
25-500-100	2.5" ALL SS; 1/4" BOTTOM STEM; 0-100PSI/KPA	\$88.71	\$83.85	\$77.78
25-500-300	2.5" ALL SS; 1/4" BOTTOM STEM; 0-300PSI/KPA	\$93.15	\$88.04	\$81.66
25-500-1000	2.5" ALL SS; 1/4" BOTTOM STEM; 0-1000PSI/KPA	\$91.37	\$86.36	\$80.10
25-500-1500	2.5" ALL SS; 1/4" BOTTOM STEM; 0-1500PSI/KPA	\$65.17	\$61.60	\$57.14
25-510-100	2.5" ALL SS; 1/4" CENTER BACK; 0-100PSI/KPA	\$109.20	\$103.21	\$95.73
25-510-300	2.5" ALL SS; 1/4" CENTER BACK; 0-300PSI/KPA	\$100.96	\$95.43	\$88.52
25-510-1000	2.5" ALL SS; 1/4" CENTER BACK; 0-1000PSI/KPA	\$74.12	\$70.06	\$64.98
25-510-1500	2.5" ALL SS; 1/4" CENTER BACK; 0-1500PSI/KPA	\$100.85	\$95.32	\$88.41



Liquid Filled Gauges
ABS

Liquid Filled Gauges - ABS

Part #	Description	1+	10+	25+
25-900-30	2.5" ABS; 1/4" BOTTOM STEM; 0-30PSI	\$30.31	\$28.65	\$26.58
25-900-60	2.5" ABS; 1/4" BOTTOM STEM; 0-60PSI	\$23.51	\$22.22	\$20.61
25-900-100	2.5" ABS; 1/4" BOTTOM STEM; 0-100PSI	\$33.60	\$31.76	\$29.45
25-900-160	2.5" ABS; 1/4" BOTTOM STEM; 0-160PSI	\$33.60	\$31.76	\$29.45
25-900-200	2.5" ABS; 1/4" BOTTOM STEM; 0-200PSI	\$30.31	\$28.65	\$26.58
25-900-300	2.5" ABS; 1/4" BOTTOM STEM; 0-300PSI	\$30.31	\$28.65	\$26.58
25-900-400	2.5" ABS; 1/4" BOTTOM STEM; 0-400PSI	\$32.63	\$30.84	\$28.61



Dry Gauges
ABS

Dry Gauges - ABS

Part #	Description	1+	10+	25+
20-110-160	2" ABS; DRY; 1/4" CENTER BACK; 0-160PSI/KPA	\$17.85	\$16.87	\$15.65
20-110-200	2" ABS; DRY; 1/4" CENTER BACK; 0-200PSI/KPA	\$16.50	\$15.60	\$14.47



400 Series
S.S. Needle Valve

Accessories

Part #	Description	1+	10+	25+
120MFS	1/4" Mx1/4" F SS MINI NEEDLE VALVE	\$70.34	\$66.48	\$61.66
120MFS-PM1	1/4" Mx1/4" F SS MINI NEEDLE VAL. PANL-MNT.	\$61.60	\$58.22	\$54.01
403-FFS	3/8" FPT 316SS NEEDLE VALVE	\$103.14	\$97.49	\$90.42
404-FFS	1/2" FPT 316SS NEEDLE VALVE	\$140.64	\$132.93	\$123.30
25-459-1-SS-PMC	PANEL MOUNT CLAMP; 2.5"; STAINLESS STEEL	\$7.90	\$7.47	\$6.92
25-459-1-PMC	PANEL MOUNT CLAMP; 2.5"; 900 SERIES	\$3.70	\$3.50	\$3.25
20-110-PMC	PANEL MOUNT CLAMP; 2"; 100 SERIES	\$4.01	\$3.79	\$3.51

SOLENOID VALVES



Stainless Steel Solenoid Valves

Part #	Description	1+	3+	6+	12+
SV12-110V-YCD	1/2" SS SOLENOID; 110V; N/C	\$69.38	\$65.78	\$62.17	\$57.67
SV12-220V-YCD	1/2" SS SOLENOID; 220V; N/C	\$71.20	\$67.50	\$63.81	\$59.18
SV34-110V-YCD	3/4" SS SOLENOID; 110V; N/C	\$88.26	\$83.68	\$79.09	\$73.36
SV34-220V-YCD	3/4" SS SOLENOID; 220V; N/C	\$88.26	\$83.68	\$79.09	\$73.36
SV1-110-YCD	1" SS SOLENOID; 110V; N/C	\$114.27	\$108.34	\$102.40	\$94.98
SV1-220-YCD	1" SS SOLENOID; 220V; N/C	\$135.86	\$128.80	\$121.75	\$112.92

Installation Supplies



Good Water Warehouse, Inc.

CANADASALES@GOODWATERWAREHOUSE.COM
GOODWATERWAREHOUSE.COM

PRICES ARE USD FOB
CALGARY/NEWMARKET

ALBERTA

TEL: (403) 252-7972
TEL: (888) 668-1234
FAX: (888) 227-3291

ONTARIO

TEL: (905) 868-9287
TEL: (888) 868-9287
FAX: (905) 830-0512

NOTES

Lined area for notes with a large, faint 'GOOD' logo watermark in the center.

Installation Supplies



NOTES

Handwriting practice area with horizontal blue lines and a large, faint watermark of the GOOD logo (a globe with the word 'GOOD' in the center).



PUMPS & MOTORS





AQUATEC® BOOSTER & DELIVERY PUMPS



6800 & 8800 Series Booster Pumps increase low feed pressure to RO systems which improves quality and production. **5800 & 550 Delivery (Demand) Pumps** transfer water to the point-of-use, for example an icemaker or wetbar. The **ERP-1000** is used for energy recovery in RO applications. It increases efficiency by as much as 400% and saves up to 80% of normal waste water.



6800 Series Low Flow
Booster Pumps

6800 Low Flow Booster Pumps (up to 50 GPD) (Order PSW and Transformer Separately)

Part #	Description	1±	4±	12±	60±
6840-2J03-B221S	CDP-LFO-1/4" JG; 2.0; NYLON; FLEX; 1 PK	\$79.01	\$74.49	\$72.23	\$69.98
6841-2J03-B223S	CDP-LFO-1/4" JG; 2.5; UNIVERSAL BRACKET 24VAC	\$78.46	\$73.98	\$71.74	\$69.50
Part #	Description	1±	60±	144±	
6840-2J03-B221	CDP-LFO-1/4" JG; 2.0; NYLON; FLEX; 12 PK	\$71.64	\$69.47	\$67.30	
6841-2J03-B221	CDP-LFO-1/4" JG; 2.5; FLEX 24VAC	\$71.64	\$69.47	\$67.30	

6800 Series Transformers

Part #	Description	1±	4±	12±	60±
TAS114-19EP	120 VOLT 68	\$17.00	\$14.20	\$13.40	\$12.40
TAS234-19EP	230 VOLT 68	\$15.02	\$12.55	\$11.84	\$10.96



8800 Series High Flow
Booster Pumps

8800 High Flow Booster Pumps (50-100 GPD) (Order PSW and Transformer Separately)

Part #	Description	1±	4±	12±	60±
8841-2J03-B424	CDP-HFO-1/4" JG 2.5" NYLON; METAL BASE	\$105.19	\$87.86	\$82.91	\$76.73
8851-2J03-B424	CDP-HFO-3/8" JG 2.5" NYLON; METAL-C, 120v	\$105.19	\$87.86	\$82.91	\$76.73



8800 Series
Transformer

8800 Series Transformers

Part #	Description	1±	4±	12±	60±
TACS114-48	120 VOLT 88	\$28.31	\$23.64	\$22.31	\$20.65



Tank Pressure Switch

Tank Pressure Switch - (PSW)

Part #	Description	1±	4±	12±	60±
PSW240-00	40 PSI; 1/4" JG	\$11.67	\$11.00	\$10.67	\$10.34
PSW260-00	60 PSI; 1/4" JG	\$14.17	\$11.84	\$11.17	\$10.34
PSW280-00	80 PSI; 1/4" JG	\$14.16	\$11.83	\$11.16	\$10.33
PSW340-00	40 PSI; 3/8" JG	\$14.17	\$11.84	\$11.17	\$10.34
PSW360-00	60 PSI; 3/8" JG	\$14.17	\$11.84	\$11.17	\$10.34
PSW380-00	80 PSI; 3/8" JG	\$14.17	\$11.84	\$11.17	\$10.34



5800 Series
Delivery/Demand Pumps

5800 Series Delivery / Demand Pumps

Part #	Description	1±	4±	12±	60±
5851-7E12-J574	0.7 GPM; 60 PSI; 3/8" JG; 120V CORD	\$111.10	\$104.75	\$101.58	\$98.40
5853-1E12-J574	0.9 GPM; 60 PSI; 3/8" JG; 120V CORD	\$111.09	\$104.74	\$101.57	\$98.39
5852-7E12-J584	1.2 GPM; 60 PSI; 3/8" JG; 120V CORD	\$111.10	\$104.75	\$101.58	\$98.40
5853-1E10-J524	1.5 GPM; 60 PSI; 3/8" JG; 120V CORD	\$111.09	\$104.74	\$101.57	\$98.39
5853-7E12-B424	.85 GPM; 60 PSI; 3/8" JG; 24VAC	\$101.10	\$95.33	\$92.44	\$89.55

Misting Pumps

Part #	Description	1±	4±	12±	60±
8852-2P02-T424	CDP 160 PSI BYPASS-24V AC/DC-3/8 J.G.	\$73.25	\$71.03	\$68.81	
Part #	Description	1±	4±	12±	60±
5854-2P02-N584	1.3 GPM OPEN FLOW; 160PSI; 3/8" W/CORD	\$108.06	\$101.89	\$98.80	\$95.71

Variable Speed Pumps Solve the problem of variable pressure fluctuations and variable flow rates on multiple outlets. This pump maintains constant pressure & flow rates.

5800 Series Variable Speed Delivery / Demand Pump

Part #	Description	1±	4±	12±	60±
5853-GB12-V81D	0.1-1GPM; 40 PSI; CORD; 115V; 3/8"	\$294.53	\$277.70	\$269.29	\$260.87



550 Smart Pump



Smart Pump Fitting (QTS-556)



550 Super Flow Pump

Quieter Option for 50gpd or Less Use Part# ERP500-S



ERP 1000 Permeate Pump



Auto Flush Timers



ES0 2-Way Solenoid (SV-2-24V)



Double Wire Harness (21-127)



Low Pressure Protection Switch (LPS340-G)

550 Series Variable Speed Delivery / Demand Pumps (Requires QC Fitting - Sold Separately)

Part #	Description	1+	4+	12+	60+
5501-1EN2-V77D	SMART PUMP; 3.8 GPM; 60PSI; NO FITTING	\$298.18	\$281.14	\$272.62	\$264.10
5502-IDN2-V77D	SMART PUMP; 4.5 GPM; 50PSI; NO FITTING	\$301.20	\$283.99	\$275.38	\$266.78

550 Series Variable Speed QC Fittings

Part #	Description	1+	10+	25+	50+
QTS-556	1/2" MIP x 3/4" QDC FITTING [IND]	\$4.03	\$3.36	\$3.19	\$2.96
QJE-554	1/2" JG x 3/4" QDC ELBOW FITTING [IND]	\$6.04	\$5.04	\$4.79	\$4.43
QJS-554	1/2" JG X 3/4" QDC STRAIGHT [IND] FITTING	\$6.04	\$5.04	\$4.79	\$4.43

Part #	Description	1+	100+	1000+
3576-10	1/2" CTS ELBOW PUMP FITTING; BULK	\$5.54	\$5.04	\$4.54

550 Series Super Flow Delivery / Demand Pumps

Part #	Description	1+	4+	12+	60+
5512-1E12-J586	3.2 GPM; 60 PSI; 1/2" F; 120V CORD	\$139.47	\$131.50	\$127.52	\$123.53
5511-1E12-B638	3.35 GPM; 60 PSI; 1/2" NPT; 12VDC W/O CORD	\$138.51	\$130.59	\$126.64	\$122.68
5513-1E12-J526	5 GPM; 60 PSI; 1/2" F; 120V CORD	\$139.47	\$131.50	\$127.52	\$123.53
5513-1E01-B606	6 GPM; 60 PSI; 1/2" F; 120V W/O CORD	\$141.55	\$133.46	\$129.42	\$125.37
5513-1E01-J606	6 GPM; 60 PSI; 1/2" F; 120V; CORD	\$151.54	\$142.88	\$138.55	\$134.22

ERP 1000 Permeate Pump:

- Non Electrical
- Improves water quality
- Increases recovery time
- Reduces waste water multiple outlets. This pump maintains constant pressure & flow rates.

Permeate Pumps

Part #	Description	1+	8+	80+
ERP500-S	ERP500; 1/4" JG [Up to 50 GPD]	\$48.82	\$47.37	\$45.18
ERP1000-JG-S	ERP1000; 1/4" JG [50-100 GPD]	\$48.82	\$47.37	\$45.18

Part #	Description	1+	40+	80+
ERP1000-JG	ERP1000; 1/4" JG [Bulk Pack QTY 40]	\$45.26	\$43.91	\$41.88

Auto Flush Timers - (Order Wire Harness Separately)

Part #	Description	1+	10+	25+	50+
AFR603	300 ML/MIN	\$68.62	\$57.32	\$54.09	\$50.05
AFR604	400 ML/MIN	\$68.63	\$57.33	\$54.10	\$50.06
AFR605	500 ML/MIN	\$68.62	\$57.32	\$54.09	\$50.05
AFR606	600 ML/MIN	\$68.62	\$57.32	\$54.09	\$50.05
AFR607	700 ML/MIN	\$68.62	\$57.32	\$54.09	\$50.05
AFR608	800 ML/MIN	\$68.62	\$57.32	\$54.09	\$50.05

Electronic Shut Off [ESO]

Part #	Description	1+	10+	50+
SV-2-24V	1/4" FPT SOLENOID; 2 WAY-NC; 24VAC; W/LEADS	\$11.54	\$10.77	\$10.00

Accessories

Part #	Description	1+	10+	25+	50+
21-028	LOW PRESSURE PROTECTION WIRE	\$2.54	\$2.12	\$2.00	\$1.85
21-127	DOUBLE WIRE HARNESS(11") F-MF	\$2.55	\$2.13	\$2.01	\$1.86
21-160	10' LEAK DETECTOR HARNESS SET	\$2.03	\$1.70	\$1.60	\$1.48
21-161	TRIPLE WIRE HARNESS;12" M-FFF	\$2.03	\$1.70	\$1.60	\$1.48
LPS340-G	LOW PRESSURE PROTECTION SWITCH	\$20.47	\$17.10	\$16.13	\$14.93
PSF-370	PUMP SEDIMENT FILTER W/O FITTINGS	\$10.11	\$8.45	\$7.97	\$7.38

Part #	Description	1+	12+	60+	120+
ACT-820JG	ACCUMULATOR TANK 820ML 3/8" QC W/MOUNT BRKT	\$46.80	\$44.13	\$42.79	\$41.45



Accumulator Tank (ACT-820JG)

Pumps / Motors



SHURFLO® BOOSTER & DELIVERY PUMPS



SHURflo® has over 30 years of experience in providing quality & innovative solutions for all your fluid delivery & dispensing needs.

Gold Series RO Booster Pumps - (Order TSO & Transformer Separately)

Part #	Description	1+	6+	30+	60+
8075-111-313	LFO PUMP;24VAC;MAX.50GPD;1/4" JG	\$235.23	\$198.79	\$182.22	\$165.66



Gold Series Pump

8000 Series RO Booster Pumps - (Order TSO & Transformer Separately)

Part #	Description	1+	6+	30+	60+
8010-121-200	LFO;115V; MAX.50GPD; 3/8" FPT NO CORD	\$152.31	\$128.71	\$117.99	\$107.26
8010-101-201	LFO;24VAC;MAX.50GPD;3/8" FPT;60BP	\$200.62	\$169.54	\$155.41	\$141.28
8005-952-480	LFO;24/36VDC;MAX.50GPD;3/8" FPT;S.	\$203.24	\$171.76	\$157.44	\$143.13
8010-101-209	LFO;24V;MAX.50GPD;3/8" F;DEMAND/S.	\$132.85	\$118.26	\$111.35	\$105.98
8010-101-200	LFO;24V; MAX.50GPD; 3/8" FPT	\$165.52	\$139.87	\$128.22	\$116.56
8010-102-210	HFO;24V; MAX.100GPD; 3/8" FPT	\$241.46	\$204.05	\$187.05	\$170.04



8000 Series Booster Pump

Transformers

Part #	Description	1+	6+	30+	60+
60-044-00	110-240 VAC IN; 24VDC OUT;HFO TRAN	\$76.36	\$64.53	\$59.16	\$53.78

Tank Pressure Switch - (TSO)

Part #	Description	1+	6+	30+	60+
94-090-01	TSO W/WIRE HARNESS; 1/4" JG	\$48.59	\$41.06	\$37.64	\$34.22
94-090-02	TSO W/WIRE HARN; 3/8 JG	\$34.14	\$28.85	\$26.44	\$24.04



Tank Pressure Switch

2088 Series Delivery Pumps

Part #	Description	1+	6+	30+	60+
2088-474-144	24VDC 3.0GPM; 1/2" MPT; N/C	\$119.09	\$100.64	\$92.25	\$83.87
2088-564-144	230VAC 3.0GPM; 1/2" MPT; N/C	\$141.34	\$119.45	\$109.49	\$99.54
2088-594-154	115VAC 3.3GPM; 1/2" MPT; N/C	\$137.66	\$116.34	\$106.64	\$96.95



2088 Series Delivery Pump

8000 Series Delivery Pumps

Part #	Description	1+	6+	30+	60+
8005-733-155	115VAC 1.4GPM; 1/2" MPT; N/C	\$149.34	\$126.21	\$115.69	\$105.17
8005-733-255	115VAC 1.4GPM; 3/8" FPT; N/C	\$154.05	\$130.19	\$119.34	\$108.49
8025-213-256	115VAC 1.6GPM; 3/8" FPT; CORD	\$258.98	\$218.86	\$200.62	\$182.38
8005-791-255	230VAC 1.2GPM; 3/8" FPT; N/C	\$240.11	\$202.91	\$186.01	\$169.10



8000 Series Delivery Pump

Low Voltage Delivery Systems

Part #	Description	1+	6+	30+	60+
82-100-00	115VAC 0.9GPM W/TRAN;3/8" JG LPP	\$279.54	\$236.23	\$216.55	\$196.86

Accessories

Part #	Description	1+	6+	30+	60+
15-012	ELECTRIC FAUCET	\$24.78	\$22.06	\$20.77	\$19.77
94-080-01	LOW PRESSURE SWITCH	\$65.41	\$55.28	\$50.67	\$46.07

Part #	Description	1+	12+	24+	48+
181-201	ACCUMULATOR TANK; 24 OZ; 1/2"	\$77.63	\$65.60	\$60.14	\$54.67



Accumulator Tank



FLOJET® BOOSTER & DELIVERY PUMPS

FLOJET

Quad Pump Accessories



4000 Series
High Flow Quad Pump

Part #	Description	1+	4+	12+
20381-002	QUAD PORTS 1/2" HB STR.	\$6.36	\$5.94	\$5.52
20381-009	QUAD PORTS 1/2" HB ELL. (1 PAIR)	\$6.35	\$5.93	\$5.50
20381-039	QUAD DEMAND PORT KIT 1/2" NPT	\$7.74	\$7.22	\$6.71

BW Series Bottled Water Dispensing System

Part #	Description	1+	6+	12+
BW5000-000A	BOTTLED WATER SP-SINGLE INLET; 115VAC	\$230.86	\$215.47	\$200.08

BevJet Compact Dispensing Kit

Part #	Description	1+	4+	12+
BLC1011010A	110V 1/4" JG 1GPM	\$158.67	\$148.09	\$137.52



Single Bottled Water
Dispensing System
(BW5000-000A)



Bottled Water Dispensing System

- Float switch for automatic shut-off when bottle is empty
- Built-in check valve to prevent back flow
- Universal seal cap fits most water containers
- Compact size for easy mounting
- 20" discharge hose included
- Easily installed



BevJet Compact Dispensing Kit
(BLC1011010A)



PROCON® COMMERCIAL PUMPS - BRASS & STAINLESS STEEL

PROCON®



Series 2 Brass Pump

PROCON®

Series 2 pumps have the same features as the Series 1 except they do not have the integral strainer. Series 1, 2, and 3 are available in 11 flow rates: 15, 25, 35, 50, 60, 70, 80, 100, 110, 125 and 140 gallons per hour at 250 psi.



Series 2 Brass Pump
(front & back view)



Series 3
Stainless Steel Pump

PROCON®

Series 3 pumps boast all the unique features of other PROCON® pumps. Because the pump body and all the metal parts are made from stainless steel, the Series 3 is well suited for pumping a variety of fluids not suitable with brass.

FOLLOW THESE STEPS TO SELECT THE APPROPRIATE PROCON® MODEL NUMBER:

Select the appropriate Series number

The third character (111A100F11AA) position specifies the series number. There are six series (1 - Brass 3/8" NPT Ports w/strainer, 2 - Brass 3/8" NPT Ports, 3 - Stainless steel 3/8" NPT Ports, 4 - Brass 1/2" NPT Ports, 5 - Stainless steel 1/2" NPT Ports, and 6 - Stainless steel 1" NPT Ports) offered within the Procon Rotary Vane Product Line.

Select the appropriate Mounting & Drive Configuration

The fourth character position (111A100F11AA) specifies the mounting and drive configuration. There are five configurations (A - Clamp-on with .188" Double Flat Drive, B - Clamp-on with 1143 Bronze Coupling, C - Clamp-on with 1143-2 Plastic Coupling, E - Bolt-on with single flat drive, & N - Bolt-on with key slot drive) to choose from.

Series 2 - Brass Pumps - 3/8" NPT Ports; Clamp-on

Part #	Description	1+	4+	12+	24+
112A015F11XX	15 GPH NSF BRASS PUMP; W/O RELIEF	\$95.60	\$89.22	\$82.85	\$79.03
112A025F11XX	25 GPH NSF BRASS PUMP; W/O RELIEF	\$95.60	\$89.22	\$82.85	\$79.03
102A035F11XX	35 GPH BRASS PUMP; W/O RELIEF	\$95.91	\$89.52	\$83.13	\$79.29
112A035F11XX	35 GPH NSF BRASS PUMP; W/O RELIEF	\$95.60	\$89.22	\$82.85	\$79.03
112A050F11XX	50 GPH BRASS PUMP; W/O RELIEF	\$95.60	\$89.22	\$82.85	\$79.03
102A070F11XX	70 GPH BRASS PUMP; W/O RELIEF	\$95.91	\$89.52	\$83.13	\$79.29
102A080F11BA225	80 GPH BRASS PUMP; 225 PSI	\$101.65	\$94.87	\$88.09	\$84.03
112A080F11XX	80 GPH NSF BRASS PUMP; W/O RELIEF	\$84.17	\$78.56	\$72.95	\$69.58
112A100F11AA200	100 GPH NSF BRASS PUMP; 200 PSI	\$103.04	\$96.17	\$89.30	\$85.18
112A100F11AA250	100 GPH NSF BRASS PUMP; 250 PSI	\$103.04	\$96.17	\$89.30	\$85.18
102A125F11XX	125 GPH BRASS PUMP; W/O RELIEF	\$95.91	\$89.52	\$83.13	\$79.29
112A125F11AA190	125 GPH NSF BRASS PUMP; 190 PSI	\$90.62	\$84.58	\$78.54	\$74.91
112A125F11XX	125 GPH NSF BRASS PUMP; W/O RELIEF	\$95.91	\$89.52	\$83.13	\$79.29
102A140F11BA225	140 GPH BRASS PUMP; 225 PSI	\$105.84	\$98.79	\$91.73	\$87.50
112A140F11XX	140 GPH NSF BRASS PUMP; W/O RELIEF	\$96.61	\$90.17	\$83.73	\$79.86

Series 3 - Stainless Steel Pumps - 3/8" NPT Ports; Clamp-on

Part #	Description	1+	4+	12+	24+
103A035F31BA170	35 GPH SS PUMP: 170 PSI	\$115.53	\$107.83	\$100.13	\$95.51
103A035F31BA225	35 GPH SS PUMP: 225 PSI	\$115.53	\$107.83	\$100.13	\$95.51
103A035F31XX	35 GPH SS PUMP; W/O RELIEF	\$115.53	\$107.83	\$100.13	\$95.51
113A035F31XX	35 GPH NSF SS PUMP; W/O RELIEF	\$125.77	\$117.38	\$109.00	\$103.97
103A050F31XX	50 GPH SS PUMP; W/O RELIEF	\$132.05	\$123.25	\$114.45	\$109.17
113A050F31XX	50 GPH NSF SS PUMP; W/O RELIEF	\$125.77	\$117.38	\$109.00	\$103.97
103A070F31XX	70 GPH SS PUMP; W/O RELIEF	\$132.05	\$123.25	\$114.45	\$109.17
103A080F31BA200	80 GPH SS PUMP: 200 PSI	\$132.05	\$123.25	\$114.45	\$109.17
103A080F31XX	80 GPH SS PUMP; W/O RELIEF	\$125.77	\$117.38	\$109.00	\$103.97
113A080F11AA200	80 GPH NSF SS PUMP: 200 PSI	\$115.82	\$108.10	\$100.38	\$95.75
103A100F31BA170	100 GPH SS PUMP; 170 PSI	\$115.53	\$107.83	\$100.13	\$95.51
103B100F31BA170	100 GPH SS PUMP; 170PSI	\$132.05	\$123.25	\$114.45	\$109.17
103B100F31BA200	100 GPH SS PUMP; 200 PSI	\$122.18	\$114.04	\$105.89	\$101.00
103B100F31XX	100 GPH SS PUMP; W/O RELIEF	\$114.33	\$106.71	\$99.09	\$94.52
113A100F31XX	100 GPH NSF SS PUMP; W/O RELIEF	\$125.77	\$117.38	\$109.00	\$103.97
113B100F31BA225	100 GPH NSF SS PUMP: 225 PSI	\$125.77	\$117.38	\$109.00	\$103.97
103A125F31BA170	125 GPH SS PUMP; 170 PSI	\$115.53	\$107.83	\$100.13	\$95.51
113A125F31XX	125 GPH SS PUMP; W/O RELIEF	\$137.52	\$128.36	\$119.19	\$113.69
103B125F31XX	125 GPH SS PUMP; W/O RELIEF	\$114.33	\$106.71	\$99.09	\$94.52
113A125F31XX	125 GPH NSF SS PUMP; W/O RELIEF	\$137.52	\$128.36	\$119.19	\$113.69



PROCON®

Series 4 - Brass Pumps - 1/2" NPT Ports; Clamp-on

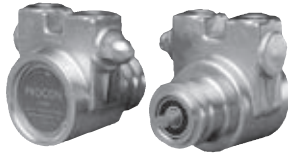

Series 4 Brass Pump
(front & back view)

Part #	Description	1+	4+	9+	18+
104A140F11XX	140 GPH BRASS PUMP; W/O RELIEF	\$182.96	\$170.76	\$158.56	\$151.25
104B140F31BA200	140 GPH BRASS PUMP; 200 PSI	\$194.88	\$181.89	\$168.90	\$161.10
104B140F11AA225	140 GPH BRASS PUMP; 225 PSI	\$182.96	\$170.76	\$158.56	\$151.25
114B165F11AA250	165 GPH NSF BRASS PUMP; 250 PSI	\$195.17	\$182.16	\$169.15	\$161.34
114B165F11XX	165 GPH NSF BRASS PUMP; W/O RELIEF	\$188.05	\$175.51	\$162.97	\$155.45
114B165F31XX	165 GPH NSF BRASS PUMP; W/O RELIEF	\$180.14	\$168.13	\$156.12	\$148.91
104B190F11BA225	190 GPH BRASS PUMP; 225 PSI	\$193.82	\$180.90	\$167.98	\$160.22
114B190F11AA250	190 GPH NSF BRASS PUMP; 250 PSI	\$185.80	\$173.41	\$161.02	\$153.59
114B190F31XX	190 GPH NSF BRASS PUMP; W/O RELIEF	\$189.13	\$176.52	\$163.91	\$156.35
104B215F11BA225	215 GPH BRASS PUMP; 225 PSI	\$184.58	\$172.28	\$159.97	\$152.59
114B215F11BA250	215 GPH NSF BRASS PUMP; 250 PSI	\$193.82	\$180.90	\$167.98	\$160.22
104B240F11BA225	240 GPH BRASS PUMP; 225 PSI	\$193.80	\$180.88	\$167.96	\$160.21
114B240F11XX	240 GPH BRASS PUMP; W/O RELIEF	\$197.47	\$184.30	\$171.14	\$163.24
114B240F11XX	240 GPH NSF BRASS PUMP; W/O RELIEF	\$197.47	\$184.30	\$171.14	\$163.24
114B240F31XX	240 GPH NSF BRASS PUMP; W/O RELIEF	\$180.13	\$168.12	\$156.11	\$148.91
104B265F11XX	265 GPH BRASS PUMP; W/O RELIEF	\$188.07	\$175.53	\$162.99	\$155.47
114B265F11BA250	265 GPH NSF BRASS PUMP; 250 PSI	\$193.82	\$180.90	\$167.98	\$160.22
114B330F31XX	330 GPH NSF BRASS PUMP; W/O RELIEF	\$189.23	\$176.62	\$164.00	\$156.43

PROCON®

Series 4 & 5 pumps

are designed and built to meet your needs for flow rates ranging from 115 - 330 gallons per hour at 250 psi. These PROCON® pumps maintain all the quality features and construction of our Series 1, 2, & 3 pumps.

Series 4 - Brass Pumps - 1/2" NPT Ports; Bolt-on

Part #	Description	1+	4+	9+	18+
104E140F11XX	140 GPH BRASS PUMP; W/O RELIEF	\$205.58	\$191.88	\$178.17	\$169.95
114E140F31XX	140 GPH NSF BRASS PUMP; W/O RELIEF	\$186.73	\$174.28	\$161.83	\$154.36
104E165F11AA170	165 GPH BRASS PUMP; 170 PSI	\$213.45	\$199.22	\$184.99	\$176.46
104E165F11BA225	165 GPH BRASS PUMP; 225 PSI	\$196.07	\$183.00	\$169.93	\$162.08
104E165F11XX	165 GPH BRASS PUMP; W/O RELIEF	\$205.58	\$191.88	\$178.17	\$169.95
114E165F31XX	165 GPH NSF BRASS PUMP; W/O RELIEF	\$186.73	\$174.28	\$161.83	\$154.36
104E190F11XX	190 GPH BRASS PUMP; W/O RELIEF	\$196.07	\$183.00	\$169.93	\$162.08
114E190F31XX	190 GPH NSF BRASS PUMP; W/O RELIEF	\$186.73	\$174.28	\$161.83	\$154.36
104E215F11BA250	215 GPH BRASS PUMP; 250 PSI	\$186.73	\$174.28	\$161.83	\$154.36
104E215F11XX	215 GPH BRASS PUMP; W/O RELIEF	\$186.73	\$174.28	\$161.83	\$154.36
104E240F11BA225	240 GPH BRASS PUMP; 225 PSI	\$212.16	\$198.02	\$183.87	\$175.39
114E240F11XX	240 GPH NSF BRASS PUMP; W/O RELIEF	\$214.11	\$199.84	\$185.57	\$177.00
114E240F31XX	240 GPH NSF BRASS PUMP; W/O RELIEF	\$196.81	\$183.69	\$170.57	\$162.69
104E265F11AA200	265 GPH BRASS PUMP; 200 PSI	\$213.45	\$199.22	\$184.99	\$176.46
104E265F11AA225	265 GPH BRASS PUMP; 225 PSI	\$213.45	\$199.22	\$184.99	\$176.46
114E330F11XX	330 GPH NSF BRASS PUMP; W/O RELIEF	\$215.66	\$201.28	\$186.90	\$178.28
114E330F31XX	330 GPH NSF BRASS PUMP; W/O RELIEF	\$198.21	\$185.00	\$171.79	\$163.86

Series 5 - Stainless Steel Pumps - 1/2" NPT Ports; Clamp-on

Part #	Description	1+	4+	9+	18+
105B140F31BA200	140 GPH SS PUMP; 200 PSI	\$194.69	\$181.71	\$168.73	\$160.95
105A165F31XX	165 GPH SS PUMP; W/O RELIEF	\$182.70	\$170.52	\$158.34	\$151.04
105B165F31XX	165 GPH SS PUMP; W/O RELIEF	\$182.70	\$170.52	\$158.34	\$151.04
105B165F31BA220	165 GPH SS PUMP; 220 PSI	\$194.70	\$181.72	\$168.74	\$160.95
105B165F31BA250	165 GPH SS PUMP; 250 PSI	\$194.70	\$181.72	\$168.74	\$160.95
115B165F31XX	165 GPH NSF SS PUMP; W/O RELIEF	\$203.29	\$189.74	\$176.19	\$168.06
105B190F31XX	190 GPH SS PUMP; W/O RELIEF	\$185.90	\$173.51	\$161.11	\$153.68
115B240F31BA170	240 GPH NSF SS PUMP; 170 PSI	\$204.44	\$190.81	\$177.18	\$169.00
115B240F31XX	240 GPH NSF SS PUMP; W/O RELIEF	\$195.20	\$182.19	\$169.18	\$161.37
115B330F31XX	330 GPH NSF SS PUMP; W/O RELIEF	\$195.27	\$182.26	\$169.24	\$161.43



Series 5
Stainless Steel Pump

Series 5 - Stainless Steel Pumps - 1/2" NPT Ports; Bolt-on

Part #	Description	1+	4+	9+	18+
105E115F31XX	115 GPH SS PUMP; W/O RELIEF	\$197.60	\$184.43	\$171.26	\$163.35
105E165F31XX	165 GPH SS PUMP; W/O RELIEF	\$188.98	\$176.38	\$163.78	\$156.22
105E215F31XX	215 GPH SS PUMP; W/O RELIEF	\$188.99	\$176.39	\$163.79	\$156.23
115E240F31XX	240 GPH SS PUMP; W/O RELIEF	\$198.45	\$185.22	\$171.99	\$164.06
115E240F31XX	240 GPH NSF SS PUMP; W/O RELIEF	\$198.45	\$185.22	\$171.99	\$164.06
105E330F31XX	330 GPH SS PUMP; W/O RELIEF	\$190.38	\$177.69	\$165.00	\$157.38
115E330F31XX	330 GPH NSF SS PUMP; W/O RELIEF	\$199.91	\$186.58	\$173.25	\$165.26



PROCON®

Series 6 - Stainless Steel Pumps - 1" NPT Ports; Bolt-on



Series 6
Stainless Steel Pump

Part #	Description	1±	2±	4±	8±
116N300F11XX250	300 GPH NSF SS PUMP; W/O RELIEF	\$737.09	\$687.95	\$638.81	\$609.33
106N360F11XX	360 GPH SS PUMP; W/O RELIEF	\$736.07	\$687.00	\$637.93	\$608.49
106N480F11XX	480 GPH SS PUMP; W/O RELIEF	\$736.07	\$687.00	\$637.93	\$608.49
106N540F11XX	540 GPH SS PUMP; W/O RELIEF	\$736.07	\$687.00	\$637.93	\$608.49
116N540F11XX	540 GPH NSF S.S.PUMP; W/O RELIEF	\$737.09	\$687.95	\$638.81	\$609.33
106N600F11XX	600 GPH SS PUMP; W/O RELIEF	\$667.08	\$622.61	\$578.14	\$551.45
106N660F11XX	660 GPH SS PUMP; W/O RELIEF	\$736.07	\$687.00	\$637.93	\$608.49
116N660F11XX	660 GPH NSF S.S. PUMP; W/O RELIEF	\$700.43	\$653.74	\$607.04	\$579.02

Accessories

Part #	Description	1±	5±	10±	25±
1048-1C	56C FRAME MOTOR ADAPTER	\$50.69	\$47.31	\$43.93	\$41.90
1113	PROCON PUMP V-BAND CLAMP	\$1.92	\$1.79	\$1.67	\$1.59
1143	COUPLING; SLOTTED ROTOR C/O	\$4.42	\$4.12	\$3.83	\$3.65
3206	PROCON 3600 COUPLING, 5/8" X 7/8"	\$119.62	\$111.65	\$103.67	\$98.89
3206-1	PROCON 3600 COUPLING, 5/8" X 5/8"	\$104.67	\$97.70	\$90.72	\$86.53
3207-56C	PROCON FRAME ADAPTER	\$62.83	\$58.64	\$54.45	\$51.94
3208	PROCON SHAFT KEY	\$0.35	\$0.33	\$0.31	\$0.29
3216	PROCON FASTENERS	\$6.29	\$5.87	\$5.45	\$5.20

PROCON®

Series 6 pumps are designed and built to meet your needs for higher flows. The flow rate capacity for this pump ranges from 300 to 660 gallons per hour at 250 psi. This series pump is available only in bolt-on style.

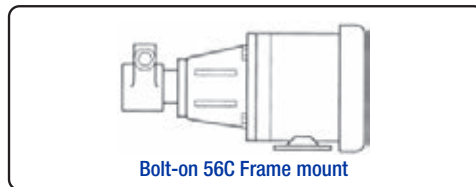

Bolt-on 56C Frame mount

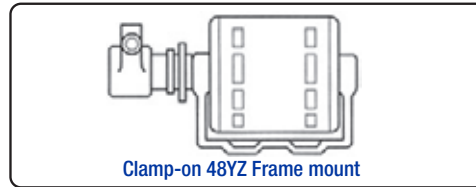

Clamp-on 48YZ Frame mount

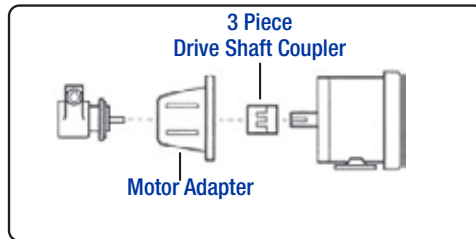

(Bolt-on 56C Frame mount)

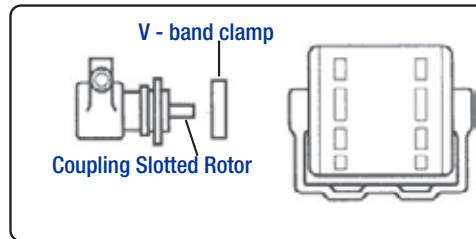

(Clamp-on 48YZ Frame mount)

48YZ CLAMP ON MOTORS



48YZ Motor

NEMA 48YZ Clamp-on Carbonator motors, Single phase, Open drip proof

Part #	Description	1±	5±	10±	25±
4725	1/4 HP MOTOR; 115V	\$313.67	\$293.30	\$281.08	\$260.71
4805	1/3 HP MOTOR 100-120/240V; 50/60	\$242.55	\$226.38	\$210.21	\$200.51
H684	1/2 HP MOTOR; 100-120/240; 50/60	\$273.59	\$255.35	\$237.11	\$226.17
H714	3/4 HP MOTOR; 1-PHASE; 115/230V	\$299.21	\$279.26	\$259.32	\$247.35



TESTING & MONITORING EQUIPMENT



Testing / Monitoring



EXTECH® TESTING & MONITORING EQUIPMENT



Extech Testing & Monitoring Equipment



(CL200)



(DO600)

Part #

CL200
CL205
DO600
EC405
EC505
EC510
PH100
PH103
PH105
PH115
RE300
RE305
CL203
EC400
EC500
PH110

Description

EXSTIK CHLORINE METER
EXSTIK CHLORINE ELECTRODE ONLY
EXTECH DISSOLVED OXYGEN METER
EXSTIK EC/TDS/SAL/TEMP ELECTRODE
EC500 REPLACEMENT PROBE
EXSTIK 5 IN 1; pH/EC/TDS/SALINITY/TEMP KIT
EXSTIK PH METER
EXSTIK PH BUFFER;20PK (4,7,10)
EXSTIK PH ELECTRODE ONLY
PH110 REFILLABLE ELECTRODE (ONLY)
EXSTIK ORP METER
EXSTIK ORP ELECTRODE (ONLY)
EXSTIK CHLORINE REAGENT (100)
EXSTIK 4 IN 1; EC/TDS/SALINITY/TEMP
EXSTIK 5 IN 1; pH/EC/TDS/SALINITY/TEMP
EXSTIK pH METER W/REFILABLE ELECTRODE

1±

\$228.01
\$142.69
\$264.25
\$43.88
\$71.55
\$223.24
\$118.30
\$36.25
\$33.39
\$56.28
\$127.83
\$67.16
\$26.71
\$127.84
\$194.62
\$146.92

5±

\$222.94
\$139.51
\$258.38
\$42.90
\$69.96
\$218.28
\$115.67
\$35.44
\$32.64
\$55.03
\$124.99
\$65.66
\$26.11
\$125.00
\$190.30
\$143.66



(EC400)



(EC500)



(PH110)



(RE300)



MYRON L[®] TESTING & MONITORING EQUIPMENT



ULTRA PEN
EC/TDS
(PT1)



ULTRA PEN - Bluetooth
EC/TDS/Salinity/Temp
(PTBT1)



pDS/pH/Conductivity * Meters
(EP11/PH)



UltraMeters
(4PII & 6PIIFCE)



Controllers
750II Series

* Carry Case available
See Part# PTP
on next page

Ultrapen Pocket Testers

Part #	Description	1±	2±	5±
PT1	EC/TDS/SALINITY POCKET TESTER	\$195.89	\$183.65	\$176.30
PT3	ORP/TEMP POCKET TESTER	\$238.29	\$223.40	\$214.46
PTBT1	BLUETOOTH; EC/TDS/SALINITY/TEMP	\$398.99	\$374.05	\$359.09

DS Conductivity Meters

Part #	Description	1±	2±	5±
RO-1	0-1250 PPM (RED/BLUE COLOR DISPLAY)	\$312.49	\$292.96	\$281.24
512T5	0-5000 PPM	\$354.89	\$332.71	\$319.40
512T10	0-10,000 PPM	\$362.10	\$339.47	\$325.89
532T1	0-50, 500, 5000 PPM	\$482.52	\$452.36	\$434.27
532T2	0-25, 250, 2500 PPM	\$468.52	\$439.24	\$421.67
532M1	0-50, 500, 5000 MS	\$468.52	\$439.24	\$421.67
EP10	0-10, 100, 1000, 10000 MS	\$523.22	\$490.52	\$470.90
EP	0-0.5, 5, 50, 500, 5000 MS (2-30 MEGOHM)	\$484.64	\$454.35	\$436.17

pDS/pH/Conductivity Meters

Part #	Description	1±	2±	5±
EP11/PH	0-10,100,1000,10000 MS; 2-12 PH	\$743.28	\$696.82	\$668.95

UltraMeter

Part #	Description	1±	2±	5±
4PII	ULTRAMETER; CON/TDS/RES/TEMP	\$959.09	\$899.15	\$863.18
6PIIFCE	ULTRA,2;CON,TDS,RES,PH,ORP,& CHL.TEMPW/LSI CAL	\$1,281.76	\$1,201.65	\$1,153.58

Conductivity Monitor/Controllers (Requires Sensor)

Part #	Description	1±	2±	5±
756II-114	0-100 PPM ANALOG MONITOR ONLY	\$636.43	\$596.65	\$572.79
756II-116	0-200 PPM ANALOG MONITOR ONLY	\$636.43	\$596.65	\$572.79
757II-116	0-200 PPM ANALOG MONITOR/CONTROL	\$731.83	\$686.09	\$658.65
757II-118	0-500 PPM ANALOG MONITOR/CONTROL	\$731.83	\$686.09	\$658.65
758II-114	0-100 PPM DIGITAL MONITOR/CONTROL	\$694.52	\$651.11	\$625.07
758II-114-4A	0-100 PPM DIG. MONITOR/CONTROL;4-20mA	\$931.53	\$873.31	\$838.38
758II-116	0-200 PPM DIG. MONITOR/CONTROL	\$729.71	\$684.10	\$656.74
758II-120	0-1,000 PPM DIG. MONITOR/CONTROL	\$694.52	\$651.11	\$625.07
758II-122	0-2,000 PPM DIG. MONITOR/CONTROL	\$694.52	\$651.11	\$625.07
758II-111	0-50 µS DIGITAL MONITOR/CONTROL	\$694.52	\$651.11	\$625.07
758II-119	0-1,000 µS DIG. MONITOR/CONTROL	\$694.52	\$651.11	\$625.07

Conductivity Sensors

Part #	Description	1±	2±	5±
CS51	CONDUCTIVITY CELL-10 FT.	\$270.52	\$253.61	\$243.47
CS51-100	CONDUCTIVITY CELL-100 FT.	\$606.32	\$568.43	\$545.69
CS51-PV	CONDUCTIVITY CELL; 1/2" PVDF	\$313.34	\$293.76	\$282.01
CS52	CONDUCTIVITY CELL (RANGES > 20,000 MS)	\$474.88	\$445.20	\$427.40

Resistivity Controllers (Requires Sensor)

Part #	Description	1±	2±	5±
754II-11	DIGITAL MONITOR ONLY	\$649.57	\$608.97	\$584.62

Resistivity Sensors

Part #	Description	1±	2±	5±
CS10-HPSS	RESISTIVITY CELL; SS	\$586.40	\$549.75	\$527.76
CS10-S-PV	RESISTIVITY CELL; 1/2" PVDF	\$406.62	\$381.21	\$365.96

TDS 442 Solutions (Quart)

Part #	Description	1±	2±	5±
442-15QT	15 PPM	\$25.44	\$23.85	\$22.90
442-30	30 PPM	\$25.52	\$23.93	\$22.97
442-150QT	150 PPM	\$25.52	\$23.93	\$22.97
442-300	300 PPM	\$25.44	\$23.85	\$22.90



pH Buffer Solutions (Quart)

Part #	Description	1±	2±	5±
PH BUFFER 4	PH 4	\$25.52	\$23.93	\$22.97
PH BUFFER 7	PH 7	\$25.02	\$23.46	\$22.52
PH BUFFER 10	PH 10	\$25.52	\$23.93	\$22.97



pH Buffer Solutions
(PHBUFFER 4, 7, & 10)

Accessories

Part #	Description	1±	2±	5±
RE-10	RANGE EXTENDER (10X)	\$37.32	\$34.98	\$33.59
UCC	ULTRAMETER/TECHPRO CARRY CASE	\$49.19	\$46.11	\$44.27
PTP	DS/PDS METER PORTA-KIT CARRY CASE	\$83.11	\$77.91	\$74.80

HM DIGITAL METERS



HM Digital water quality testing instruments are superior in construction and performance, yet made available at a very economic cost. HM Digital, Inc. is the only manufacturer of economical in-line dual TDS meters that measure total dissolved solids (TDS) levels of feed and product water lines simultaneously, an effective way to compare rejection rates and gauge reverse osmosis membrane, water filter and water purification performance.



(COM-100) (TDS-3) (TDS-4) (TDS-EZ)

Hand Held TDS Meters

Part #	Description	1±	10±	50±
COM-100	EC/TDS/TEMP WATERPROOF METER	\$56.55	\$52.78	\$49.01
COM-80	EC/TDS/TEMP WATER RESISTANT HYDRO TESTER	\$29.18	\$27.24	\$25.29
TDS-3	TDS & TEMP METER W/CASE; 0-9990ppm	\$10.14	\$9.47	\$8.79
TDS-4	POCKET SIZE TDS METER; 0-9990ppm w/ATC	\$15.89	\$14.83	\$13.77
TDS-EZ	ECONOMY TDS METER; 0-9990 PPM	\$15.89	\$14.83	\$13.77

Hand Held pH Meter

Part #	Description	1±	5±	25±
PH-200	WATERPROOF PH METER	\$76.21	\$71.13	\$66.05
COM-300	PH/EC/TDS/TEMP WATERPROOF METER	\$116.79	\$109.00	\$101.22



(PH-200) (COM-300) (ORP-200)

Hand Held ORP Meter

Part #	Description	1±	5±	25±
ORP-200	HAND HELD WTR/PRF ORP METER	\$126.97	\$118.50	\$110.04

Continuous Monitors

Part #	Description	1±	5±	25±
DM-2	INLINE DUAL TDS METER COMMERCIAL	\$42.00	\$39.20	\$36.40
QC1	QUICK CHECK TDS/COND MONITOR	\$22.12	\$20.65	\$19.17
DM-1	IN-LINE DUAL TDS METER; 1/4" JG	\$28.86	\$26.93	\$25.01
DM-1A	IN-LINE DUAL TDS METER; 3/8" JG	\$40.06	\$37.39	\$34.72
PSC-150	EXTENDED RANGE TDS/EC CONTROLLER	\$180.45	\$168.42	\$156.39



(DM-2)



(DM-1)



(QC1)



(PSC-150)



GOOD WATER WAREHOUSE TEST STRIPS



Test Strip Bottles

Part #	Description	1±	12±	60±
481027	CHLORIDE TEST STRIPS;50/ BOTTLE	\$18.78	\$17.53	\$16.28
480023	CHLORINE CHECK (FREE CHL) 50TEST	\$15.65	\$14.61	\$13.56
480022	CHLORINE, FREE HIGH RANGE KIT; 50/BOTTLE	\$13.11	\$12.24	\$11.37
480002	CHLORINE, FREE; TEST KIT; 50/BOTTLE	\$15.65	\$14.61	\$13.56
481026	CHLORINE,FREE, EPA CHECK;50/BOTTLE	\$18.61	\$17.37	\$16.13
480042	COPPER JOHN'S TEST 25/BOTTLE	\$13.11	\$12.24	\$11.37
481201	HYDROGEN SULFIDE KIT 50 TESTS	\$53.78	\$50.19	\$46.61
480018	IODINE - 50/BOTTLE	\$13.97	\$13.04	\$12.11
480025	IRON CHECK (FE+2) ; 0-5.0 PPM (25PK)	\$12.69	\$11.85	\$11.00
481234	OZONE CHECK TEST KIT 50/BOTTLE	\$18.19	\$16.97	\$15.76
480014	PEROXIDE - 50/BOTTLE	\$13.96	\$13.03	\$12.10
481015	PEROXIDE LOW RANGE -50/BOTTLE	\$17.34	\$16.19	\$15.03
481104	PH TEST STRIP - 50/BOTTLE	\$8.89	\$8.29	\$7.70
480026	ZINC TEST KIT 50/BOTTLE	\$14.81	\$13.82	\$12.83
480010	CHLORINE, TOTAL;TEST KIT 50/BOTTLE	\$14.81	\$13.82	\$12.83
480008	HARDNESS, TOTAL; TEST; 50/BOTTLE	\$8.38	\$7.82	\$7.27
481046	IRON LOW RANGE IDA'S 25/BOTTLE	\$13.11	\$12.24	\$11.37



Free Chlorine Test Kit (480022)



Hydrogen Sulfide Low Range Test Kit (481167)

Test Strips [30 packs - 1 Chart]

Part #	Description	1±	12±	60±
481195	BACTERIA GROWTH CHECK (30 PK, 1 CHART)	\$26.65	\$24.87	\$23.09
481110	CHLORINE, TOTAL;(30 IND.PKS, 1 COLOR CHART)	\$14.37	\$13.41	\$12.46
481108	HARDNESS, TOTAL; (30 IND. PK.S, 1 COLOR CHART)	\$9.73	\$9.08	\$8.43
480104	pH CHECK (30 IND. FOIL PACKS, 1 COLOR CHART)	\$9.73	\$9.08	\$8.43
481167	HYDROGEN SULFIDE [LOW] 30 IND.PK/1 CHART	\$14.08	\$13.14	\$12.20

Multiple Parameter Tests Packs

Part #	Description	1±	12±	60±
481199	COMPLETE HOME PESTICIDE KIT (FE/COP/CHL/NIT/PH/ALK/HARD/SUF/H2S/BAC.)	\$24.11	\$22.50	\$20.90
480015	5 WAY WATERWORKS 50/BOTTLE (CHLORINE F & T/ PH/ ALKA/ HARD)	\$13.11	\$12.24	\$11.37
481113-30	4-IN-1 CITY WATER CHECK ; 30 PACK (PH/ AKA/ CHLORINE/ HARD)	\$14.39	\$13.44	\$12.48
480005	PH/TOTAL ALAKLINITY 50/BOTTLE	\$10.58	\$9.87	\$9.17
487941	WELL WATER CHECK TEST KIT 2PK (PH/ ALAKA/ HARD/ NIT/ IRON/ NITROGEN)	\$6.35	\$5.93	\$5.50

Individual Test Strip Packs

Part #	Description	1±	12±	60±
481297-5	ARSENIC QUICK LOW RANGE TEST KIT 5PK	\$38.06	\$35.52	\$32.99
481108-2	HARDNESS TEST STRIP-2PK	\$1.02	\$0.95	\$0.89
481104-1	PH TEST STRIP - 1PK	\$0.50	\$0.47	\$0.43

CLACK® DI LIGHTS

Clack Corporation



DI Light

Resilites - (Light "GREEN" Quality Good, "RED" Below Quality)

Part #	Description	1±	5±	10±
R7031-20K	20K OHM RESILITES 110V; 1/2" MIP	\$69.84	\$66.35	\$64.02
R7031-50K	50K OHM RESILITES 110V; 1/2" MIP	\$66.83	\$63.49	\$61.26
R7031-200K	200K OHM RESILITES 110V; 1/2" MIP	\$66.83	\$63.49	\$61.26
R7031-500K	500K OHM RESILITES 110V; 1/2" MIP	\$66.83	\$63.49	\$61.26
R7031-1MEG	1 MEG OHM RESILITES 110V; 1/2" MIP	\$66.83	\$63.49	\$61.26

Testing / Monitoring



SENNOTECH® QUALITY MONITORS

Sennotech Quality Monitors

Part #	Description	1±	10±	25±
B&A TDS-1/4	BEFORE & AFTER DIGITAL TDS MTR; 1/4 COMP	\$29.82	\$27.83	\$25.84
B&A TDS-3/8	BEFORE & AFTER DIGITAL TDS MTR; 3/8 COMP	\$31.25	\$29.17	\$27.08

Flowmaster - Flowmeter

Part #	Description	1±	10±	25±
FLOWMASTER	FLOWMASTER; 1/4" QC	\$42.14	\$39.33	\$36.52
FLOWMASTER-3/8	FLOWMASTER; 3/8" QC	\$43.37	\$40.48	\$37.59



B&A TDS



FLOWMASTER

SAVANT® GALLONAGE METERS



Gallonage Meters

Part #	Description	1±	10±	50±
DF066	DIGIFLOW 6000R; MULTI FILTER GALLONS	\$23.38	\$21.82	\$20.26
DF066L	DIGIFLOW 6000RL; MULTI FILTER; LITERS	\$21.47	\$20.04	\$18.61
DF086L	DIGIFLOW 8000TL; LITERS	\$23.38	\$21.82	\$20.26
DF088	DIGIFLOW 8000T-GALLONS	\$23.38	\$21.82	\$20.26



(DF066)

HACH® TESTING & MONITORING EQUIPMENT



Hardness Test Kit

Part #	Description	1±	2±	5±
1453-00	5-B HARDNESS DROP COUNT EDTA	\$58.88	\$54.96	\$51.03





WATER CHILLERS, COOLERS & HEATERS





EVERCOLD® WATER CHILLERS & INSTANT HOT WATER SYSTEM

EVERCOLD® EVERHOT®

The **EverCold®** System features a large capacity reserve and rapid recovery design for a constant flow of cold water. Low energy consumption and operates quietly. Power: 2.1 amps. EverCold is 15" high, 8" wide, and 14" deep. There must be a 2" clearance all around the EverCold, and ventilation of the undersink cabinet is strongly recommended for effective cooling performance. Generous 1.5 gallons per hour capacity.



EverCold Water Chiller

EverHot Instant Hot Water System

<u>Part #</u>	<u>Description</u>	<u>1+</u>	<u>2+</u>	<u>5+</u>	<u>10+</u>
LVH-500-CHROME	EVERHOT® WITH HOT & COLD FAUCET	\$873.71	\$812.49	\$773.54	\$740.15
LVH-TANK	EVERHOT® TANK ONLY; 60 CUPS Per Hour	\$339.50	\$315.72	\$300.58	\$287.60
<u>Part #</u>	<u>Description</u>	<u>1+</u>	<u>2+</u>	<u>5+</u>	
WI-LVH-TANK-SS	EVERHOT® TANK ONLY; SS; 100 CUPS Per Hour	\$424.53	\$396.23	\$367.93	



EverHot (LVH-500-CHROME)
with Hot & Cold Faucet

CAPACITY: 5/8 gallons
(60 cups per hour or 67 oz. at once.)



EverHot (WI-LVH-TANK-SS)
Stainless Steel

CAPACITY: 5/8 gallons
(100 cups per hour or 67 oz. at once.)



Good Water Warehouse, Inc.

CANADASALES@GOODWATERWAREHOUSE.COM
GOODWATERWAREHOUSE.COM

PRICES ARE USD FOB
CALGARY/NEWMARKET

ALBERTA

TEL: (403) 252-7972
TEL: (888) 668-1234
FAX: (888) 227-3291

ONTARIO

TEL: (905) 868-9287
TEL: (888) 868-9287
FAX: (905) 830-0512

NOTES



VIQUA - ARROS™ UV SYSTEMS



VIQUA Arros UV Systems

- Equipped with Stream™ technology which allows for more accurate in-lamp usage measurement.
- The Tidal™ chamber aligns the inlet and outlet ports on a single plane, saving time and material.
- PolyProtect™ shield blocks UV light so the Arros UV can plumb directly to PEX and other polymer materials
- Easy-to-navigate LCD touchscreen to identify replacement part and dealer contact information.

ARROS Residential Systems

Part #	Description	1±	2±	5±
C-ARROS 9	9 GPM, 120V; 3/4" (NEMA 5-15P); 120v	\$573.75	\$521.59	\$500.73
C-ARROS 15	15 GPM, 120V; 3/4" INLET/OUTLET (NEMA 5-15P)	\$637.06	\$579.14	\$555.98
C-ARROS 22	22 GPM, 120V; 3/4" INLET/OUTLET (NEMA 5-15P)	\$884.36	\$803.96	\$771.81



(C-ARROS 9)



(C-ARROS 15)

ARROS NSF 55 Class B Validated Systems

Part #	Description	1±	2±	5±
C-ARROS 9-V	6.4 GPM 3/4" NPT INLET /OUTLET;120V	\$625.19	\$568.35	\$545.62
C-ARROS 15-V	9.4 GPM 3/4" NPT INLET /OUTLET;120V	\$702.34	\$638.49	\$612.96
C-ARROS 22-V	12.9 GPM 3/4" NPT INLET /OUTLET;120V	\$927.89	\$843.53	\$809.79

Integrated Home Systems

- Equipped with an Arros UV system
- 4.5" x 10" and 4.5" x 20" prefilters with premium 3 piece filter housings providing seamless filter replacement
- Solid steel reversible bracket



(C-ARROS 9-IHS10)



(C-ARROS 15-IHS12)

ARROS Integrated Home System

Part #	Description	1±	2±	5±
C-ARROS 9-IHS10	9 GPM; 1 x 10" SEDIMENT FILTER	\$718.17	\$652.88	\$626.77
C-ARROS 9-IHS12	9 GPM; 1 x 10" SEDIMENT FILTER 1 x 20" CARBON	\$979.32	\$890.29	\$854.68
C-ARROS 15-IHS11	15 GPM; 1 x 10" SEDIMENT FILTER	\$735.98	\$669.07	\$642.31
C-ARROS 15-IHS1	15 GPM; 1 x 10" SEDIMENT FILTER 1 x 20" CARBON	\$1,030.77	\$937.06	\$899.58
C-ARROS 15-IHS2	15 GPM; 1 x 20" SEDIMENT FILTER 1 x 20" CARBON	\$1,058.46	\$962.24	\$923.75
C-ARROS 22-IHS2	22 GPM; 1 x 20" SEDIMENT FILTER 1 x 20" CARBON	\$1,327.52	\$1,206.84	\$1,158.57

ARROS Replacement Parts

Part #	Description	1±	2±	5±
C-VA09LU	9 & 9-V REPLACEMENT LAMP & SLEEVE KIT	\$110.80	\$100.72	\$96.70
C-VA15LU	15 & 15-V REPLACEMENT LAMP & SLEEVE KIT	\$126.63	\$115.11	\$110.51
C-VA22LU	22 & 22-V REPLACEMENT LAMP & SLEEVE KIT	\$138.49	\$125.90	\$120.87
C-VA-CTRL	REPLACEMENT CONTROLLER KIT 100-240V	\$349.79	\$317.99	\$305.28
C-411111-R	DRAIN PLUG	\$7.13	\$6.48	\$6.22

Replacement Lamp





VIQUA - STERILIGHT® UV LIGHTS



(C-VH200)



(C-S2Q-OZ)



Replacement Lamps



Quartz Sleeves

Sterilight UV Systems

Part #	Description	1+	2+	5+
C-VT1	1 GPM UV; 120V (NEMA 5-15P)	\$205.77	\$187.06	\$179.58
C-VT4	3.5 GPM UV 120V (NEMA 5-15P)	\$223.57	\$203.24	\$195.12
C-VH150	5 GPM UV; 120V; 3/4" - 1"	\$340.30	\$309.36	\$296.99
C-VH200	9 GPM UV 120V (NEMA 5-15P); 3/4" - 1"	\$395.69	\$359.72	\$345.33
C-VH410	18 GPM UV; 120V (NEMA 5-15P); 3/4" - 1"	\$486.54	\$442.31	\$424.62
C-VH410M	18 GPM UV; 120V (NEMA 5-15P); MONITORED; 3/4" - 1"	\$704.32	\$640.29	\$614.68
C-VP600	24 GPM UV 120V (NEMA 5-15P); 1"	\$704.32	\$640.29	\$614.68
C-VP600M	24 GPM UV 120V (NEMA 5-15P); MONITORED; 1"	\$951.63	\$865.11	\$830.51
C-VP950	34 GPM UV 120V (NEMA 5-15P); 1.5"	\$832.92	\$757.20	\$726.91
C-VP950M	34 GPM UV 120V (NEMA 5-15P); MONITORED; 1.5"	\$1,076.27	\$978.42	\$939.29

Ozone Units

Part #	Description	1+	2+	5+
C-S2Q-OZ	OZONATOR MOD GEN 304 SS 120V/60	\$294.79	\$267.99	\$257.28
C-S8Q-OZ	OZONATOR MOD GEN 304 SS 120V/60	\$393.71	\$357.92	\$343.60

Replacement Lamps & Sleeves

Part #	Description	1+	2+	5+
C-S212RL	LAMP; SC1/SQ-PA, VT1	\$54.22	\$49.29	\$47.32
C-S287RL	LAMP; S1Q-PA,SSM-14	\$62.92	\$57.20	\$54.91
C-QS-001	QUARTZ SLEEVE S1Q-PA,SSM-14	\$28.49	\$25.90	\$24.87
C-S330RL	LAMP; S2Q-PA,S2Q, S2Q-GOLD, SSM-17, VT4	\$63.32	\$57.56	\$55.26
C-QS-330	QUARTZ SLEEVE; S2Q-PA,S2Q, S2Q-GOLD, SSM-17, VT4	\$31.66	\$28.78	\$27.63
C-S330-QL	KIT, LAMP & SLEEVE S2Q-PA/SSM-17, VT4	\$78.35	\$71.23	\$68.38
C-S463RL	LAMP; S5Q-PA, S5Q, S5Q-GOLD, SSM-24	\$68.85	\$62.59	\$60.09
C-QS-463	QUARTZ SLEEVE; S5Q-PA, S5Q, S5Q-GOLD, SSM-24	\$32.06	\$29.14	\$27.98
C-S463-QL	KIT, LAMP & SLEEVE S5Q-PA/SSM-24	\$84.68	\$76.98	\$73.91
C-S810RL	LAMP; S8Q-PA, S8Q, S8Q-GOLD,SSM-37	\$81.12	\$73.75	\$70.80
C-S36RL	LAMP; S12Q-PA, S12Q,S24Q & GOLD, 40Q,SUV24P,SSM-37	\$82.31	\$74.83	\$71.84
C-QS-012	S12Q-PA, S12Q,S24Q & GOLD, 40Q, SUV24P,SSM-37	\$49.07	\$44.61	\$42.83
C-QSO-150	QUARTZ SLEEVE; VH150	\$27.70	\$25.18	\$24.18
C-QL-150	KIT, LAMP & SLEEVE, VH150	\$86.27	\$78.42	\$75.29
C-S200RL-HO	LAMP; SPV-3.5, SPV-200, SP200-HO, SC/SCM-200, VH200	\$76.37	\$69.43	\$66.65
C-QS-001	QUARTZ SLEEVE; S1Q- PA;SSM-14, VH200	\$28.49	\$25.90	\$24.87
C-QL-200	KIT, LAMP & SLEEVE, VH200	\$88.25	\$80.22	\$77.02
C-S320RL-HO	LAMP; SPV-6, SP320-HO, SC/SCM-320	\$84.68	\$76.98	\$73.91
C-QS-320	SLEEVE; SPV-6, SP320-HO, SC/SCM-320	\$39.58	\$35.98	\$34.54
C-S410RL-HO	LAMP; SPV-410, SPV-8 & SP410-HO, VH410, VH410M	\$86.66	\$78.78	\$75.63
C-QSO-410	QUARTZ SLEEVE; VH410, VH410M	\$44.32	\$40.29	\$38.68
C-SHO410-QL	KIT, LAMP & SLEEVE; SPV-410, SPV-8 & SP410-HO	\$107.24	\$97.49	\$93.59
C-QL-410	KIT, LAMP & SLEEVE, VH410, VH410M	\$107.24	\$97.49	\$93.59
C-S600RL-HO	LAMP; SPV-600, SPV-12, SP600-HO, SC/SCM-600, VP600, VP600M	\$93.39	\$84.90	\$81.50
C-QSO-600	QUARTZ SLEEVE; VP600, VP600M	\$47.49	\$43.17	\$41.45
C-QL-600	KIT, LAMP & SLEEVE, VP600, VP600M	\$124.25	\$112.95	\$108.44
C-S740RL-HO	LAMP; SPV-740, SPV-15, SP740-HO, SC/SCM740	\$100.51	\$91.37	\$87.72
C-S950RL-HO	LAMP; SPV-950, SPV-20 & SP950-HO, VP950, VP950M	\$104.86	\$95.33	\$91.52
C-QSO-950	QUARTZ SLEEVE; VP950, VP950M	\$66.88	\$60.80	\$58.37
C-QL-950	KIT, LAMP & SLEEVE, VP950, VP950M	\$149.18	\$135.62	\$130.20
C-QS-212	QUARTZ SLEEVE; SC1/SQ-PA, VT1	\$24.94	\$22.67	\$21.76
C-S212-QL	KIT, LAMP & SLEEVE; SC1/SQ-PA, VT1	\$65.69	\$59.72	\$57.33
C-S287-QL	KIT, LAMP & SLEEVE; S1Q-PA/SSM-14	\$75.59	\$68.71	\$65.97
C-QS-810	QUARTZ SLEEVE; S8Q-PA, S8Q, S8Q-GOLD,SSM-37	\$35.62	\$32.38	\$31.08
C-S810-QL	KIT, LAMP & SLEEVE S8Q-PA/SSM-37	\$98.14	\$89.21	\$85.65
C-S150RL-HO	LAMP; SPV2.5/SP150-HO, VH150	\$75.19	\$68.35	\$65.62
C-QS-200	QUARTZ SLEEVE; SPV-3.5, SPV-200, SP200-HO, SC/SCM-200	\$34.83	\$31.66	\$30.39
C-SHO200-QL	KIT, LAMP & SLEEVE, S12Q-PA/SSM-39	\$90.22	\$82.02	\$78.74
C-SHO320-QL	KIT, LAMP & SLEEVE; SPV-6, SP320-HO, SC/SCM-320	\$102.49	\$93.17	\$89.45
C-QS-410	SLEEVE; SPV-410, SPV-8 & SP410-HO	\$44.32	\$40.29	\$38.68
C-QS-600	SLEEVE; SPV-600, SPV-12, SP600-HO, SC/SCM-600	\$47.89	\$43.53	\$41.79
C-SHO600-QL	KIT, LAMP & SLEEVE SPV-600, SPV-12, SP600-HO,SC/SCM-600	\$124.25	\$112.95	\$108.44
C-QS-740	SLEEVE; SPV-740, SPV-15, SP740-HO, SC/SCM740	\$58.17	\$52.88	\$50.77
C-QS-950	SLEEVE; SPV-950, SPV-20 & SP950-HO	\$70.83	\$64.39	\$61.82
C-SHO950-QL	KIT, LAMP & SLEEVE; SPV-950, SPV-20 & SP950-HO	\$152.34	\$138.49	\$132.96

Disinfection Systems



Ballast

Ballasts

Part #	Description	1±	2±	5±
BA-VT	100-130V; VT1, VT4	\$139.70	\$127.00	\$121.92
BA-ICE-S	100-240V; SILVER SERIES	\$188.65	\$171.50	\$164.64
BA-ICE-CL	100-240V COBALT SERIES, VH150, VH200, VH410, VP600, VP950	\$226.60	\$206.00	\$197.76
BA-ICE-CM	100-240V, FOR COBALT MONITORED, VH410M, VP600M, VP950M	\$383.90	\$349.00	\$335.04

UVMAX™ UV SYSTEMS

Disinfection Systems



UVMAX Light Commercial Systems

Part #	Description	1±	2±	5±
C-650651	UVMAX H RS 120V 1.25" x 1"NPT; 45 GPM	\$1,545.15	\$1,404.68	\$1,348.50
C-660001-R	UVMAX K 120V 2" MNPT; 80 GPM	\$3,489.94	\$3,172.67	\$3,045.76

UVMAX Light Commercial Monitored Systems

Part #	Description	1±	2±	5±
C-650652	UVMAX H PLUS 120V 1.25" x 1" NPT; 45 GPM	\$1,780.59	\$1,618.71	\$1,553.97
C-660002-R	UVMAX K PLUS 120V 2" MNPT; 80 GPM	\$3,733.28	\$3,393.89	\$3,258.13

UVMAX Pro Systems

Part #	Description	1±	2±	5±
C-650647	UVMAX PRO 10 120V 1.25"x1"NPT; NSF CLASS A	\$1,725.19	\$1,568.35	\$1,505.62
C-650653	UVMAX PRO 20 120V 1.25"x1"NPT; NSF CLASS A	\$2,112.96	\$1,920.87	\$1,844.04
C-650659	UVMAX PRO 30 120V 1.25"x1"NPT; NSF CLASS A	\$2,676.81	\$2,433.46	\$2,336.12
C-660003-R	UVMAX PRO 50 120V 2" MNPT; USEPA CERT	\$4,312.96	\$3,920.87	\$3,764.04
C-270272-R	TROJAN COMM CENTER; DRY CONTACT; G,H,J,K,PRO	\$462.96	\$420.87	\$404.04



UVMAX Pro Series
(C-650659)



(C-602810-103)

Replacement Lamps & Sleeves

Part #	Description	1±	2±	5±
C-602730	QUARTZ SLEEVE; UVMAX A	\$34.43	\$31.30	\$30.05
C-602804	LAMP; UVMAX B, B4	\$90.22	\$82.02	\$78.74
C-602731	QUARTZ SLEEVE; UVMAX B, B4	\$32.45	\$29.50	\$28.32
C-602732	QUARTZ SLEEVE; UVMAX C, C4, D, D4, D4 PLUS	\$38.79	\$35.26	\$33.85
C-602855	LAMP; UVMAX H, H PLUS, PRO 20	\$210.51	\$191.37	\$183.72
C-602975	QUARTZ SLEEVE; UVMAX H, H PLUS, PRO 20	\$54.22	\$49.29	\$47.32
C-602850-103	KIT, LAMP & SLEEVE; UVMAX J, J PLUS, K, K PLUS, PRO30, & 50	\$256.81	\$233.46	\$224.12
C-602805	LAMP; UVMAX C, C4, D, D4, D4 PLUS	\$93.79	\$85.26	\$81.85
C-602810-102	KIT, LAMP & SLEEVE; UVMAX C, C4, D, D4, D4 PLUS	\$108.82	\$98.93	\$94.97
C-602806	LAMP; UVMAX E, E4, E4 PLUS, PRO 7	\$102.89	\$93.53	\$89.79
C-602733	QUARTZ SLEEVE; UVMAX E, E4, E4 PLUS, PRO 7	\$46.70	\$42.45	\$40.76
C-602810-103	KIT, LAMP & SLEEVE; UVMAX E, E4, E4 PLUS, PRO 7	\$123.07	\$111.88	\$107.40
C-602807	LAMP; UVMAX F, F4, F4 PLUS, PRO 15	\$111.19	\$101.08	\$97.04
C-602734	QUARTZ SLEEVE; UVMAX F, F4, F4 PLUS, PRO 15	\$54.22	\$49.29	\$47.32
C-602810-104	KIT, LAMP & SLEEVE; UVMAX F, F4, F4 PLUS, PRO15	\$139.29	\$126.62	\$121.56
C-602854	LAMP; UVMAX G, G PLUS, PRO 10	\$180.44	\$164.03	\$157.47
C-602974	QUARTZ SLEEVE; UVMAX G, G PLUS, PRO 10	\$44.72	\$40.65	\$39.03
C-602850-101	KIT, LAMP & SLEEVE; UVMAX G, G PLUS, PRO 10	\$188.35	\$171.23	\$164.38
C-602856	LAMP; UVMAX J, J PLUS, K, K PLUS, PRO 30, PRO 50	\$231.88	\$210.80	\$202.37
C-602976	QUARTZ SLEEVE; UVMAX J, J PLUS, K, K PLUS, PRO 30, PRO 50	\$58.96	\$53.60	\$51.46



(C-602850-103)

Ballasts & Parts

Part #	Description	1±	2±	5±
C-650733R-002	REPLACE CONTROLLER KIT; FOR B4, C4, D4	\$292.42	\$265.83	\$255.20
C-650733R-001	REPLACE CONTROLLER KIT, D4 PREMIUM/ D4+, E4/E4+, F4/F4+	\$396.09	\$360.08	\$345.68
C-650709-003	POWER SUPPLY KIT; FOR PRO 10; 120V (2008 on)	\$782.28	\$711.16	\$682.71
C-650709-006	POWER SUPPLY KIT; FOR PRO 20; 120V (2008 on)	\$782.28	\$711.16	\$682.71
C-650709-009	POWER SUPPLY KIT; FOR PRO 30; 120V (2008 on)	\$782.28	\$711.16	\$682.71
C-660020-R	POWER SUPPLY KIT; FOR PRO 50; 120V	\$782.28	\$711.16	\$682.71
C-650627	SOLENOID VALVE KIT; 1" COMPOSITE; G+/H+/J+/PRO 10,20,30	\$363.25	\$330.22	\$317.02
C-650703	SENSOR; D/D4 PLUS, E/E4 PLUS, F/F4 PLUS, PRO 7, PRO 15	\$247.70	\$225.18	\$216.18
C-650580	SENSOR; G PLUS, H PLUS, J PLUS, K PLUS, PRO 10, 20, 30, & 50	\$296.77	\$269.79	\$259.00
C-410888-R	SOLENOID VALVE KIT; 2" FOR K, K+ & PRO 50	\$3,317.81	\$3,016.19	\$2,895.55
C-650717-001	SOLENOID KITS W/JUNCTION BOX; 120V; 3/4"NPT/FOR D4+	\$417.06	\$379.14	\$363.98
C-650717-002	SOLENOID KITS W/JUNCTION BOX; 120V; 1"NPT; E4+ & F4+	\$479.18	\$435.62	\$418.20



(C-650733R-002)



(C-650717-001)



UV DYNAMICS

UV Dynamics



All disinfection chambers are GOLD SEAL certified to:
NSF61
NSF 372
CSA b483.1



(UVD600)



Mini Rack System
(MR400E-TP2/220)



NSF Class A System



Replacement Lamps

UV Dynamics Systems

Part #	Description	1±	2±	5±
UVD240	8GPM, 30mJ 120V, SLC Ballast, 3/4" MNPT	\$281.47	\$254.40	\$240.87
UVD320E	10GPM,30mJ 120V SLE Ballast, 3/4" MNPT	\$292.05	\$263.97	\$249.93
UVD400	13GPM, 30mJ 120v LL Ballast 3/4" MNPT	\$374.91	\$338.86	\$320.84
UVD1500	50GPM, 30mJ 120V, LLG Ballast, 1" MNPT	\$687.52	\$621.42	\$588.36
UVD320	10GPM,30mJ, 120V SL Ballast 3/4" MNPT	\$366.90	\$331.62	\$313.98
UVD485	16GPM, 30mJ 120v, LL Ballast, 1" MNPT	\$413.39	\$373.64	\$353.77
UVD600	20GPM, 30mJ 120V, LLG Ballast, 1"MNPT	\$481.31	\$435.03	\$411.89
UVD1000	33GPM, 30mJ 120V, LLG Ballast, 1"MNPT	\$530.81	\$479.77	\$454.25

MINI-RACK SYSTEMS

- "U" shaped mounting bracket accommodates either flow direction
- Double "O" ring filter housings
- Falcon Stainless steel interconnect

Mini Rack Systems

Part #	Description	1±	2±	5±
MR320E-TP1/100	MINI RACK,UVD320E 10 GPM; 1 X 10"BB; NO FILTER	\$416.04	\$376.03	\$356.03
MR320E-TP1/200	MINI RACK UVD320E 10 GPM; 1 X 20"BB; NO FILTER	\$450.51	\$407.19	\$385.53
MR400E-TP2/220	MINI RACK UVD400E 13 GPM, 2 X 20"BB; NO FILTER	\$579.65	\$523.91	\$496.05

NSF Class A Systems

Part #	Description	1±	2±	5±
UVD008.40C0120LL/S	8.40C - 8gpm, 40MJ,NSF/ANSI 55 Class "A"	\$887.94	\$802.56	\$759.87
UVD011.40C0120LL/S	11.40C - 11gpm 40MJ,NSF/ANSI 55 Class "A"	\$945.55	\$854.63	\$809.17
UVD014.40C0120LL/S	14.40C - 14gpm 40 MJ,NSF/ANSI 55 Class "A"	\$1,014.06	\$916.56	\$867.80
UVD020.40C0120LLG/S	20.40C - 20gpm, 40MJ,NSF/ANSI 55 Class "A"	\$1,130.46	\$1,021.76	\$967.41

Accessories

Part #	Description	1±	2±	5±
400454	1" SOLENOID VALVE (VALVE ONLY)	\$206.03	\$186.22	\$176.32
400455	1" SOLENOID VALVE KIT; INCL REMOTE INTERFACE	\$273.50	\$247.21	\$234.06
400294	UVT100 ULTRAVIOLET TRANSMISSION METER	\$285.82	\$258.34	\$244.60

Replacement Bulbs and Sleeves

Part #	Description	1±	2±	5±
400152	UV LAMP; UVD MODELS 240, 320	\$50.83	\$45.95	\$43.50
400128	UV LAMP; UVD MODEL 400	\$59.33	\$53.62	\$50.77
400269	UV LAMP; UVD MODELS 485, 8.40C	\$68.98	\$62.35	\$59.03
400270	UV LAMP; UVD MODELS 11.40C	\$76.73	\$69.35	\$65.66
400158	UV LAMP; UVD MODELS 600, 800, 1000, 14.40C	\$77.42	\$69.98	\$66.26
400271	UV LAMP; UVD MODELS 1200, 1500 & 20.40C	\$91.98	\$83.14	\$78.72
400151	QUARTZ SLEEVE; UVD MODELS 240, 320	\$27.74	\$25.07	\$23.74
400273	QUARTZ SLEEVE; UVD MODELS 485, 8.40C	\$35.79	\$32.35	\$30.63
400129	QUARTZ SLEEVE; UVD MODELS 400	\$32.07	\$28.99	\$27.45
400157	QUARTZ SLEEVE; UVD MODELS 600, 800 & 1000	\$52.92	\$47.83	\$45.29
400274	QUARTZ SLEEVE; UVD MODEL 11.40C	\$42.23	\$38.17	\$36.14
400323	QUARTZ SLEEVE; UVD MODEL 14.40C	\$52.89	\$47.80	\$45.26
400275	QUARTZ SLEEVE; UVD MODELS 1200, 1500 & 20.40C	\$58.72	\$53.07	\$50.25

Replacement Parts

Part #	Description	1±	2±	5±
400378	REPLACEMENT QUARTZ WINDOW (UVT SENSOR)	\$14.22	\$12.85	\$12.17
400285	UV SENSOR PROBE; NSF CLASS A MODELS	\$188.15	\$170.06	\$161.01
400201	MF-SLC120 BALLAST 240	\$100.96	\$91.26	\$86.40
400203	MF-SL120 UVD 320 BALLAST	\$122.37	\$110.60	\$104.72
400206	MF-LL120/S BALLAST; UVD8.40C/11.40C	\$215.57	\$194.84	\$184.48
400373	MF-14LL120/S BALLAST; UVD14.40C	\$215.57	\$194.84	\$184.48
400250	MF-LLG120/S BALLAST; UVD20.40C	\$230.69	\$208.51	\$197.42
400195	UV SENSOR PROBE; NON-NSF MODELS	\$160.12	\$144.73	\$137.03
400235	MF-SLE120 UVD 320E BALLAST	\$109.30	\$98.79	\$93.54

Disinfection Systems



MICROFILTER® ULTRA VIOLET LIGHTS

MICROFILTER



OPP-UV Light
(OPP-UV4W)

UV Systems (Transformers not included)

Part #	Description	1±	5±	10±	20±
OPP-UV6W	6 WATT UV W/O BAL.-1/4"QC 1GPM	\$40.79	\$38.67	\$36.55	\$33.90
OPP-UV4W	4 WATT UV W/O BAL.-1/4"QC 0.53GPM	\$36.85	\$34.93	\$33.02	\$30.63

Ballasts / Transformers

Part #	Description	1±	5±	10±	20±
OPP4W-BA-110/60	FOR OPP-UV4W; 110V/60H	\$13.85	\$13.13	\$12.41	\$11.51
OPP-BA-110/60	FOR OPP-UV6W; 110V/60H	\$14.53	\$13.77	\$13.02	\$12.07
OPP4W-BA-220/50	FOR OPP-UV4W; 220V/50H	\$14.27	\$13.53	\$12.79	\$11.86
OPP-BA-220/50	FOR OPP-UV6W; 220V/50H	\$14.27	\$13.53	\$12.79	\$11.86

Replacement Lamps

Part #	Description	1±	5±	10±	50±
G6T5-4W	FOR OPP-UV4W	\$15.95	\$14.50	\$14.30	\$13.26
G6T5-6W	FOR OPP-UV6W	\$15.64	\$14.21	\$14.01	\$13.00

Mounting Clips

Part #	Description	1±	50±	250±	500±
PPC205W	2" X 2 1/2" DOUBLE CLIP-WHITE	\$0.67	\$0.63	\$0.58	\$0.54
PPC208W	2" X 2" DOUBLE CLIP-WHITE	\$0.63	\$0.59	\$0.55	\$0.51
PPC204W	2" BASE CLIP-WHITE	\$0.67	\$0.63	\$0.58	\$0.54

Transformer
Sold Separately

STENNER CHEMICAL FEEDER SYSTEMS



STENNER PUMPS

Stenner offers a complete line of highly reliable peristaltic chemical feeders with output ranges from 0.2 gallons per day (0.6 liters) to 170 gallons per day (514.8 liters) depending on model and application. Models are available as fixed output units or with single and dual adjustable outputs utilizing a patented adjustable feed rate mechanism. Output is controlled by tube size, feed rate setting and rpm.



45 & 85 Series
Single Head Adjustable

CLASSIC SERIES 45 & 85 SINGLE HEAD ADJUSTABLE OUTPUT 100PSI

Part #	Description	1±	3±	6±
45MJH1A1S	3 GPD; 100PSI; 120/60; 1/4" WHITE	\$487.57	\$462.35	\$445.54
45MJH2A1S	10 GPD; 100PSI; 120/60; 1/4" WHITE	\$487.57	\$462.35	\$445.54
45MJH7A1S	22 GPD; 100PSI; 120/60; 1/4" WHITE	\$487.57	\$462.35	\$445.54
45MJH1B1S	3 GPD; 100PSI; 220/60; 1/4" WHITE	\$487.57	\$462.35	\$445.54
45MJH2B1S	10 GPD; 100PSI; 220/60; 1/4" WHITE	\$487.57	\$462.35	\$445.54
45MJH7B1S	22 GPD; 100PSI; 220/60; 1/4" WHITE	\$487.57	\$462.35	\$445.54
85MJH1A1S	5 GPD; 100PSI; 120/60; 1/4" WHITE	\$487.57	\$462.35	\$445.54
85MJH2A1S	17 GPD; 100PSI; 120/60; 1/4" WHITE	\$487.57	\$462.35	\$445.54
85MJH7A1S	40 GPD; 100PSI; 120/60; 1/4" WHITE	\$487.57	\$462.35	\$445.54
85MJH1B1S	5 GPD; 100PSI; 220/60; 1/4" WHITE	\$487.57	\$462.35	\$445.54
85MJH2B1S	17 GPD; 100PSI; 220/60; 1/4" WHITE	\$487.57	\$462.35	\$445.54
85MJH7B1S	40 GPD; 100PSI; 220/60; 1/4" WHITE	\$487.57	\$462.35	\$445.54

Tank Systems (REPLACE XXXXXXXX WITH PN# OF ABOVE PUMP)

Part #	Description	1±	3±	6±
S7N-XXXXXXXX	TANK SYS; 7GAL NATURAL	CALL FOR PRICING		
S7G-XXXXXXXX	TANK SYS; 7GAL UV GRAY	CALL FOR PRICING		
S1N-XXXXXXXX	TANK SYS; 15GAL NATURAL	CALL FOR PRICING		
S1G-XXXXXXXX	TANK SYS; 15GAL UV GRAY	CALL FOR PRICING		
S3N-XXXXXXXX	TANK SYS; 30GAL NATURAL	CALL FOR PRICING		
S3G-XXXXXXXX	TANK SYS; 30GAL UV GRAY	CALL FOR PRICING		



7 GAL
Tank System
(Natural)



15 GAL Tank
(UV Grey)



45/85 Series
Single Head Fixed

CLASSIC SERIES 45 & 85 SINGLE HEAD FIXED OUTPUT 100PSI

Part #	Description	1±	3±	6±
45MFH1A1S	3 GPD; 100PSI; 120/60; 1/4"; FIXED RATE	\$355.61	\$337.22	\$324.95
45MFH2A1S	10 GPD; 100PSI; 120/60; 1/4"; FIXED RATE	\$355.61	\$337.22	\$324.95
45MFH7A1S	22 GPD; 100 PSI 120/60 1/4"; FIXED RATE	\$355.61	\$337.22	\$324.95
85MFH1A1S	5 GPD FIXED; 100PSI; 120/60 ; 1/4" WHITE	\$355.61	\$337.22	\$324.95
85MFH2A1S	17 GPD FIXED; 100PSI; 120/60 ; 1/4" WHITE	\$355.61	\$337.22	\$324.95
85MFH7A1S	40 GPD FIXED; 100PSI; 120/60 ; 1/4" WHITE	\$355.61	\$337.22	\$324.95



7 GAL
Tank System
(Natural) 15 GAL Tank
(UV Grey)

Tank Systems (REPLACE XXXXXXXX WITH PN# OF ABOVE PUMP)

Part #	Description	1±	3±	6±
S7N-XXXXXXXX	TANK SYS; 7GAL NATURAL	CALL FOR PRICING		
S7G-XXXXXXXX	TANK SYS; 7GAL UV GRAY	CALL FOR PRICING		
S1N-XXXXXXXX	TANK SYS; 15GAL NATURAL	CALL FOR PRICING		
S1G-XXXXXXXX	TANK SYS; 15GAL UV GRAY	CALL FOR PRICING		
S3N-XXXXXXXX	TANK SYS; 30GAL NATURAL	CALL FOR PRICING		
S3G-XXXXXXXX	TANK SYS; 30GAL UV GRAY	CALL FOR PRICING		

ECON FP Series Pumps

Part #	Description	1±	3±	6±
E20PHF81S	ECON-FP;4.5GPD;80PSI;120/60;1/4"	\$378.33	\$358.76	\$345.71
E20PHG81S	ECON-FP;16GPD;80PSI;120/60;1/4"	\$378.33	\$358.76	\$345.71
E20PHH81S	ECON-FP;30GPD;80PSI;120/60;1/4"	\$378.33	\$358.76	\$345.71



ECON FP Pump

Water Meters

Part #	Description	1±	3±	6±
JLP0750-2PPG	PLASTIC WATER METER; 3/4", 2 PULSE/GALLON	\$200.70	\$190.32	\$183.40
JLP0750-4PPG	PLASTIC WATER METER; 3/4", 4 PULSE/GALLON	\$200.70	\$190.32	\$183.40
JLP1000-1PPG	PLASTIC WATER METER; 1", 1 PULSE/GALLON	\$238.03	\$225.72	\$217.51
JLP1500-1PPG	PLASTIC WATER METER; 1.5", 1 PULSE/GALLON	\$656.50	\$622.54	\$599.90
SSMRS20-1PPG	STAINLESS 2" METER, 1 PULSE/GALLON; NSF 372	\$945.94	\$897.02	\$864.40



Water Meters

Pump Control Module (PCM)

Part #	Description	1±	3±	6±
PCM1	PUMP CONT MODULE 0.1-1 SEC	\$229.16	\$217.30	\$209.40
PCM5	PUMP CONT MODULE 0.5 - 5 SEC	\$229.16	\$217.30	\$209.40
PCM10	PUMP CONT MODULE 1.0 - 10.0 SEC	\$229.16	\$217.30	\$209.40

Flow Switch

Part #	Description	1±	3±	6±
EC500 SWITCH	ECON PUMP (INC ADAPTER & PVC TEE)	\$94.55	\$89.66	\$86.40

Pump Tubes (45/85/100/170 & SVP Series)

Part #	Description	1±	3±	6±
UCCP201	#1 PUMP TUBE WITH FERRULES 2PACK	\$32.10	\$30.44	\$29.34
MCCP201	#1 PUMP TUBE WITH FERRULES 5PACK	\$70.96	\$67.29	\$64.85
UCCP202	#2 PUMP TUBE WITH FERRULES 2PACK	\$32.10	\$30.44	\$29.34
MCCP202	#2 PUMP TUBE WITH FERRULES 5PACK	\$70.96	\$67.29	\$64.85
UCCP207	#7 PUMP TUBE WITH FERRULES 2PACK	\$32.10	\$30.44	\$29.34
MCCP207	#7 PUMP TUBE WITH FERRULES 5PACK	\$70.96	\$67.29	\$64.85



Pump Tubes

Pump Tubes (ECON FP Series)

Part #	Description	1±	3±	6±
EC30F-2	ECON F TUBE;FERRULE;1/4";2PK	\$29.51	\$27.98	\$26.97
EC30G-2	ECON G TUBE;FERRULE;1/4";2PK	\$29.51	\$27.98	\$26.97
EC30H-2	ECON H TUBE;FERRULE;1/4";2PK	\$29.51	\$27.98	\$26.97

Service Assemblies (45/85/100/170 & SVP SERIES)

Part #	Description	1±	3±	6±
MSK120	MOTOR SERVICE REPAIR KIT 120V	\$109.90	\$104.22	\$100.43
MSK220	MOTOR SERVICE REPAIR KIT 220V	\$109.90	\$104.22	\$100.43
FSK100	FEED RATE CNTRL SERVICE KIT	\$45.80	\$43.43	\$41.85
FC5040D	FEED RATE CNTRL w/Shaft; Single Head ADJ 45/85	\$215.38	\$204.24	\$196.82
PSKH01	#1 PUMP HEAD SERVICE KIT	\$47.72	\$45.25	\$43.61
PSKH02	#2 PUMP HEAD SERVICE KIT	\$47.72	\$45.25	\$43.61
PSKH07	#7 PUMP HEAD SERVICE KIT	\$47.72	\$45.25	\$43.61
UC3ASYD	ROLLER ASSEMBLY,COMPLETE; NOT QUICKPRO	\$34.64	\$32.85	\$31.65
QP500-1	QUICKPRO ROLLER ASSEMBLY	\$34.64	\$32.85	\$31.65
QP101-1	#1 QUICKPRO Pump Head w/Ferrules 1/4" & Duckbill	\$114.96	\$109.01	\$105.05
QP102-1	#2 QUICKPRO Pump Head w/Ferrules 1/4" & Duckbill	\$114.96	\$109.01	\$105.05
QP107-1	#7 QUICKPRO Pump Head w/Ferrules 1/4" & Duckbill	\$114.96	\$109.01	\$105.05



Motor Service Repair Kit
(MSK120)

Disinfection Systems



Miscellaneous Parts

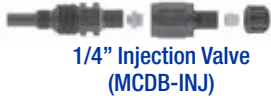

1/4" Injection Valve
(MCDB-INJ)



3/8" Injection Valve
(UCINJ38)

Part #	Description	1±	3±	6±
UCDBINJ	INJECTION CHECK VALVE 1/4"	\$16.08	\$15.25	\$14.69
MCDB-INJ	INJECTION CHECK VALVE 1/4" (5 PK)	\$59.12	\$56.06	\$54.02
UCINJ38	INJECTION CHECK VALVE 3/8"	\$19.88	\$18.85	\$18.17
MCINJ38	INJECTION CHECK VALVE 3/8" (5 PK)	\$80.28	\$76.13	\$73.36
UCCV-DB0	CHECK VALVE DUCKBILL ONLY (2 PK)	\$10.57	\$10.03	\$9.66
MCCVDB0	CHECK VALVE DUCKBILL ONLY (5 PK)	\$17.74	\$16.82	\$16.21
ST114	SUCTION LINE STRAINER;1/4"	\$19.68	\$18.67	\$17.99
ST138	SUCTION LINE STRAINER 3/8"	\$19.68	\$18.67	\$17.99
UCFC5ID	INDEX PLATE	\$22.82	\$21.64	\$20.86
FC5K00D	INDEX SPIDER PLATE	\$30.43	\$28.86	\$27.81
UCFC5AD	MAIN SHAFT SINGLE HEAD/ ADJUSTABLE OUTPUT	\$33.81	\$32.06	\$30.90
UCAK-100	1/4" NUTS (10 PK)	\$17.32	\$16.42	\$15.83
UCAK-200	1/4"FERRULE(10 PAK)	\$7.80	\$7.40	\$7.13
MP90000	RAIN ROOF FOR STENNER PUMP	\$14.29	\$13.55	\$13.06
MP80000	MOUNTING BRACKET	\$17.32	\$16.42	\$15.83
QP100-1	UNIVERSAL TUBE HOUSING COVER W/ BUSHING	\$23.69	\$22.46	\$21.64
QP400-1	UNIVERSAL QP TUBE HOUSING	\$31.70	\$30.06	\$28.96
PMBRPL2	ROTOR ASSY W BEARING/BRACKET/O-RINGS	\$67.78	\$64.28	\$61.94
AK600	1/4" STENNER FLOW INDICATOR	\$18.46	\$17.51	\$16.87

Disinfection Systems

MAZZEI® INJECTOR COMPANY - INJECTORS



Mazzei Injectors



Mazzei Injectors

Part #	Description	1±	5±	10±
384	1/2" MNPT ; PVDF	\$57.02	\$53.22	\$49.42
484	1/2" MNPT ; PVDF	\$57.02	\$53.22	\$49.42
484A	3/4" MNPT ; PVDF	\$57.02	\$53.22	\$49.42
584	3/4" MNPT ; PVDF	\$57.02	\$53.22	\$49.42
684	3/4" MNPT ; PVDF	\$57.02	\$53.22	\$49.42
878	1" MNPT ; PVDF	\$111.57	\$104.13	\$96.69
978	1" MNPT ; PVDF	\$111.57	\$104.13	\$96.69
1078	1" MNPT ; PVDF	\$111.57	\$104.13	\$96.69
1583A	1.5" MNPT ; PVDF	\$159.74	\$149.10	\$138.45
1584A-PVDF	1.5" MNPT ; PVDF	\$159.74	\$149.10	\$138.45



Good Water Warehouse, Inc.

CANADASALES@GOODWATERWAREHOUSE.COM
GOODWATERWAREHOUSE.COM

PRICES ARE USD FOB
CALGARY/NEWMARKET

ALBERTA

TEL: (403) 252-7972

TEL: (888) 668-1234

FAX: (888) 227-3291

ONTARIO

TEL: (905) 868-9287

TEL: (888) 868-9287

FAX: (905) 830-0512

NOTES

Disinfection Systems

